

NJ ENTERPRISES

Block # 4, Rashid Minhas Road, Small Industries Estate Sialkot - Pakistan.

Whatsapp: Mob: 0092 333 8733922
Phone: 0092 52 3257502
Fax: 0092 52 3257501

E-mail: akif@nj-ent.co
njenterprisespk@yahoo.com
Website: www.nj-ent.com

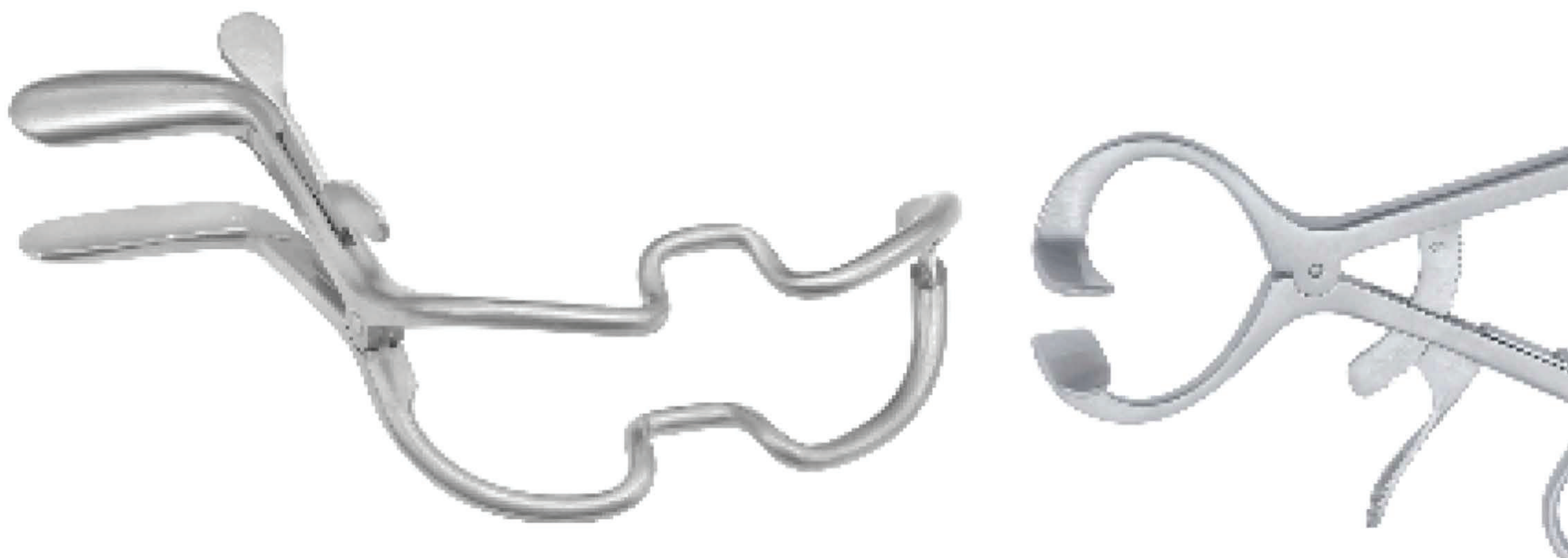

Oral Maxillo-Facial Instruments

Finger Protectors, Mouth Gag
 Finger-Protektoren, Mund-Gags
 Protectores de dedo, Mordaza De la Boca
 Protections de doigt, Bâillon De Bouche
 Protezioni Finger, Bocca Bavaglio

Adams Napkin Holder

Consisting of Chain and Two Crocodile Forceps



Catalog #	Size
OM-011-01	Standard

Langenbeck Finger Protector



Catalog #	Diameter
OM-015-01	Ø 18.0 mm
OM-015-02	Ø 21.0 mm
OM-015-03	Ø 22.0 mm

Maunder Mouth Gag
 Wood



Catalog #	Size
OM-018-10	Standard

Heister Mouth Gag



Catalog #	Size
OM-030-13	13 cm (5")

Obwegeser Mouth Gag



Catalog #	Size
OM-032-11	11 cm (4 1/4")

Mouth Gag
 Mund-Gags
 Mordaza De la Boca
 Bâillon De Bouche
 Bocca Bavaglio

Molt Mouth Gag

Catalog #	Size
OM-035-11	11 cm (4 ¼")
OM-035-14	13 cm (5")



Denhart Mouth Gag

Catalog #	Size, Jaw Size
OM-039-12	13 cm (5"), 16 mm



Roser-Koenig Mouth Gag

Catalog #	Size
OM-041-16	16 cm (6 ¼")
OM-041-20	20 cm (8")

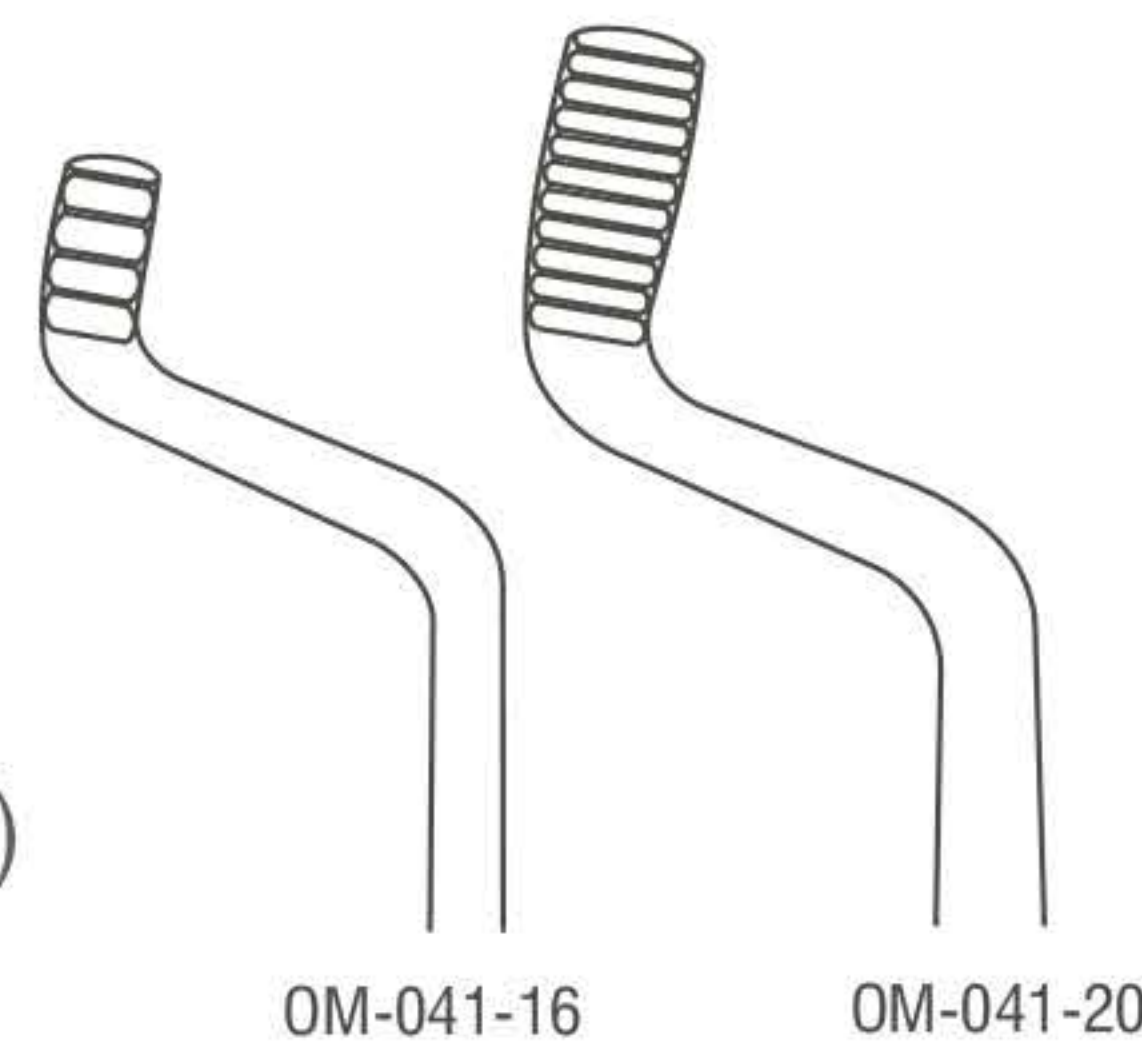

Fergusson-Ackland Mouth Gag

Catalog #	Size
OM-043-18	14.5 cm (5 ¾")
OM-043-20	18 cm (7")



Jennings Mouth Gag

Catalog #	Size
OM-047-09	10.5 cm (4")
OM-047-11	12.5 cm (5")
OM-047-13	14.5 cm (5 ¾")
OM-047-15	16.5 cm (6 ½")



Mouth Gag
 Mund-Gags
 Mordaza De la Boca
 Bâillon De Bouche
 Bocca Bavaglio

Whitehead Mouth Gag
 Without Tongue Depressor Ratchet

Catalog #	Size
OM-049-11	11 cm (4 1/4")
OM-049-13	13 cm (5")
OM-049-15	15 cm (6")



Whitehead Mouth Gag
 With Tongue Depressor Ratchet

Catalog #	Size
OM-051-13	13 cm (5")

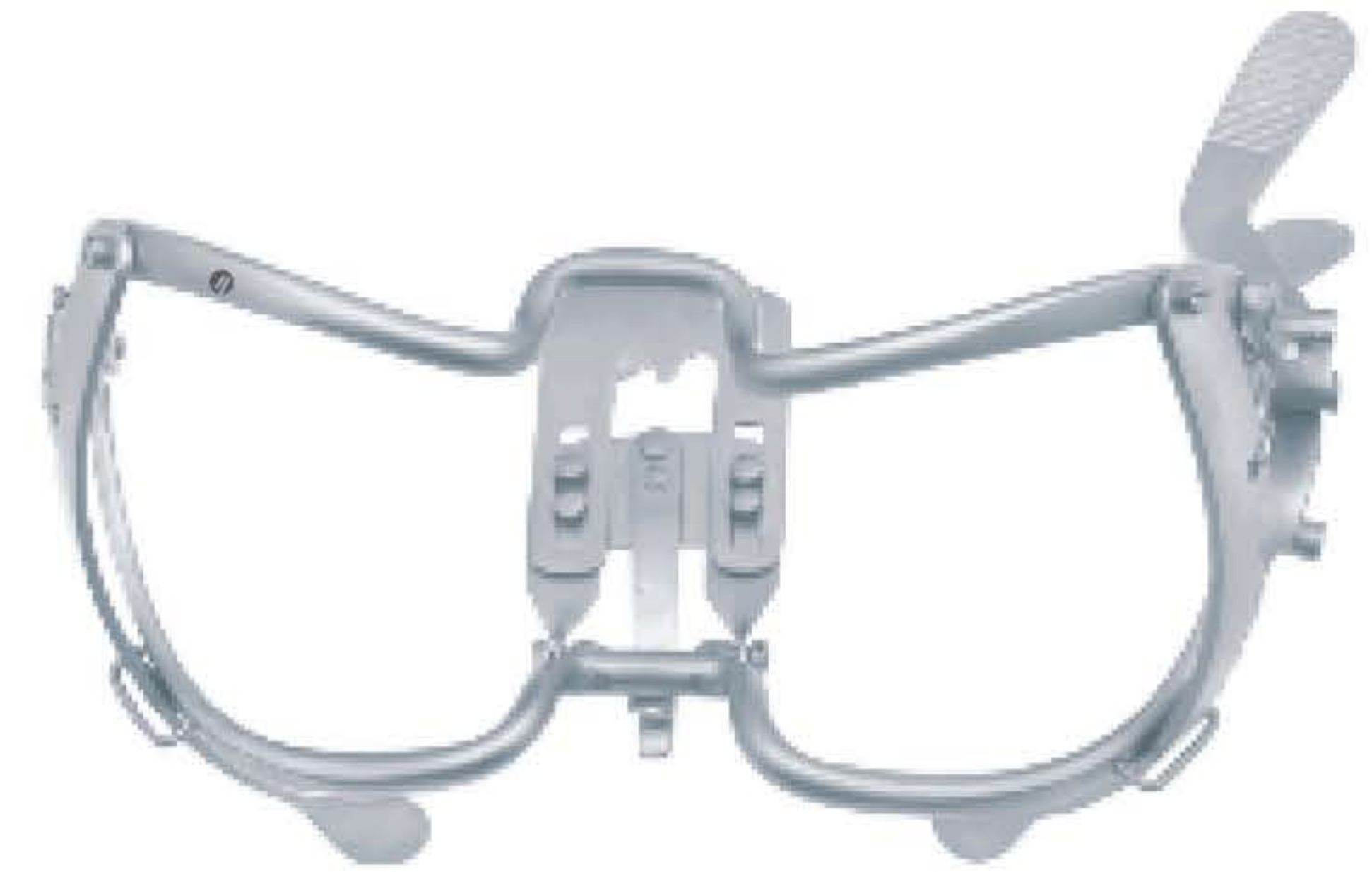

Negus Chest Support for Mouth Gag

Catalog #	Size
OM-058-00	20 cm (8")



Kilner-Doughty Mouth Gag Complete
 With 3 Tongue Depressors

Catalog #	Size
OM-060-00	Standard



Kilner-Doughty Mouth Gag
 Frame Only

Catalog #	Size
OM-061-00	14.5 cm (5 3/4")



Mouth Gag
Mund-Gags
Mordaza De la Boca
Bâillon De Bouche
Bocca Bavaglio

Kilner-Doughty Tongue Depressor
Fenestrated Blade for Suction

Catalog #	Size, Blade Size
OM-063-01	13.5 cm (5 1/4"), 70 x 29 mm
OM-063-02	13.5 cm (5 1/4"), 80 x 34 mm
OM-063-03	13.5 cm (5 1/4"), 85 x 38 mm



Davis-Boyle Mouth Gag Complete
With 5 Tongue Depressors Ref:- OM-073-01 to OM-073-05

Catalog #	Size
OM-070-00	Standard



Davis-Boyle Mouth Gag
Frame Only

Catalog #	Size
OM-071-00	Adult
OM-071-01	Child



Davis-Boyle Tongue Depressor
With Fixed Suction Tube

Catalog #	Size, Blade Size
OM-073-01	13.5 cm (5 1/4"), 110 x 26 mm
OM-073-02	13.5 cm (5 1/4"), 95 x 25 mm
OM-073-03	13.5 cm (5 1/4"), 80 x 24 mm
OM-073-04	13.5 cm (5 1/4"), 65 x 23 mm
OM-073-05	13.5 cm (5 1/4"), 30 x 20 mm

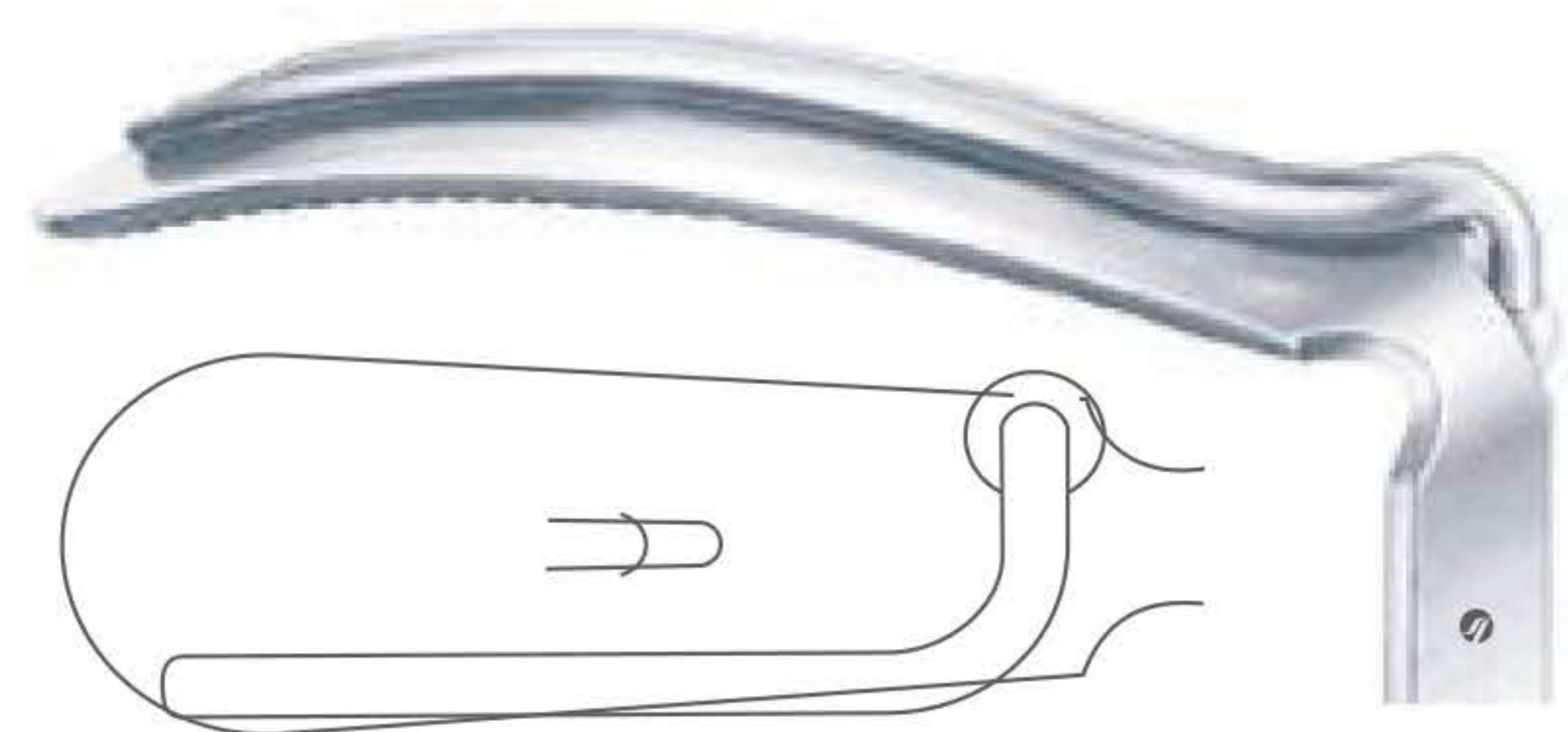

Davis-Boyle Tongue Depressor
With Suction Tube

Catalog #	Size, Blade Size
OM-073-05	13.5 cm (5 1/4"), 30 x 20 mm



Mouth Gag
 Mund-Gags
 Mordaza De la Boca
 Bâillon De Bouche
 Bocca Bavaglio

Mclvor Mouth Gag Complete

With 3 Tongue Depressors Ref:- OM-083-01 to OM-083-03

Catalog #	Size
OM-080-00	Standard



Mclvor Mouth Gag Frame Only

Catalog #	Size
OM-081-00	15 cm (6")



Mclvor Tongue Depressor

Catalog #	Size, Blade Size
OM-083-01	13.5 cm (5 1/4"), 100 x 26 mm
OM-083-02	13.5 cm (5 1/4"), 85 x 25 mm
OM-083-03	13.5 cm (5 1/4"), 75 x 23 mm



Dingmann Mouth Gag Complete

With 3 Tongue Depressors Ref:- OM-093-01 to OM-093-03

Catalog #	Size
OM-090-00	Standard



Dingmann Mouth Gag

Catalog #	Size
OM-091-00	14.5 cm (5 3/4")



Mouth Gag
 Mund-Gags
 Mordaza De la Boca
 Bâillon De Bouche
 Bocca Bavaglio

Dingmann Tongue Depressor

Catalog #	Size, Blade Size
OM-093-01	13.5 cm (5 1/4"), 65 x 25 mm
OM-093-02	13.5 cm (5 1/4"), 70 x 29 mm
OM-093-03	13.5 cm (5 1/4"), 80 x 32 mm



Negus Tongue Depressor

Catalog #	Size, Blade Size
OM-097-01	13.5 cm (5 1/4"), 70 x 20 mm
OM-097-02	13.5 cm (5 1/4"), 80 x 30 mm
OM-097-03	13.5 cm (5 1/4"), 95 x 35 mm



Russel-Davis Tongue Depressor

Catalog #	Size, Blade Size
OM-099-01	13.5 cm (5 1/4"), 18 x 55 mm
OM-099-02	13.5 cm (5 1/4"), 22 x 65 mm
OM-099-03	13.5 cm (5 1/4"), 25 x 75 mm
OM-099-04	13.5 cm (5 1/4"), 28 x 65 mm
OM-099-05	13.5 cm (5 1/4"), 32 x 75 mm
OM-099-06	13.5 cm (5 1/4"), 37 x 80 mm
OM-099-07	13.5 cm (5 1/4"), 40 x 90 mm
OM-099-08	13.5 cm (5 1/4"), 45 x 100 mm



Draffin Bipod Complete

Catalog #	Size, Detail
OM-100-00	Standard, With 2 Draffin Bipod Rod Ref:- OM-100-48
OM-100-01	40 cm (15 3/4"), Maguaran , Plate For Holding Draffin Bipod
OM-100-48	48 cm (19"), Draffin Bipod Rod , With 4 Rings for Varying Height

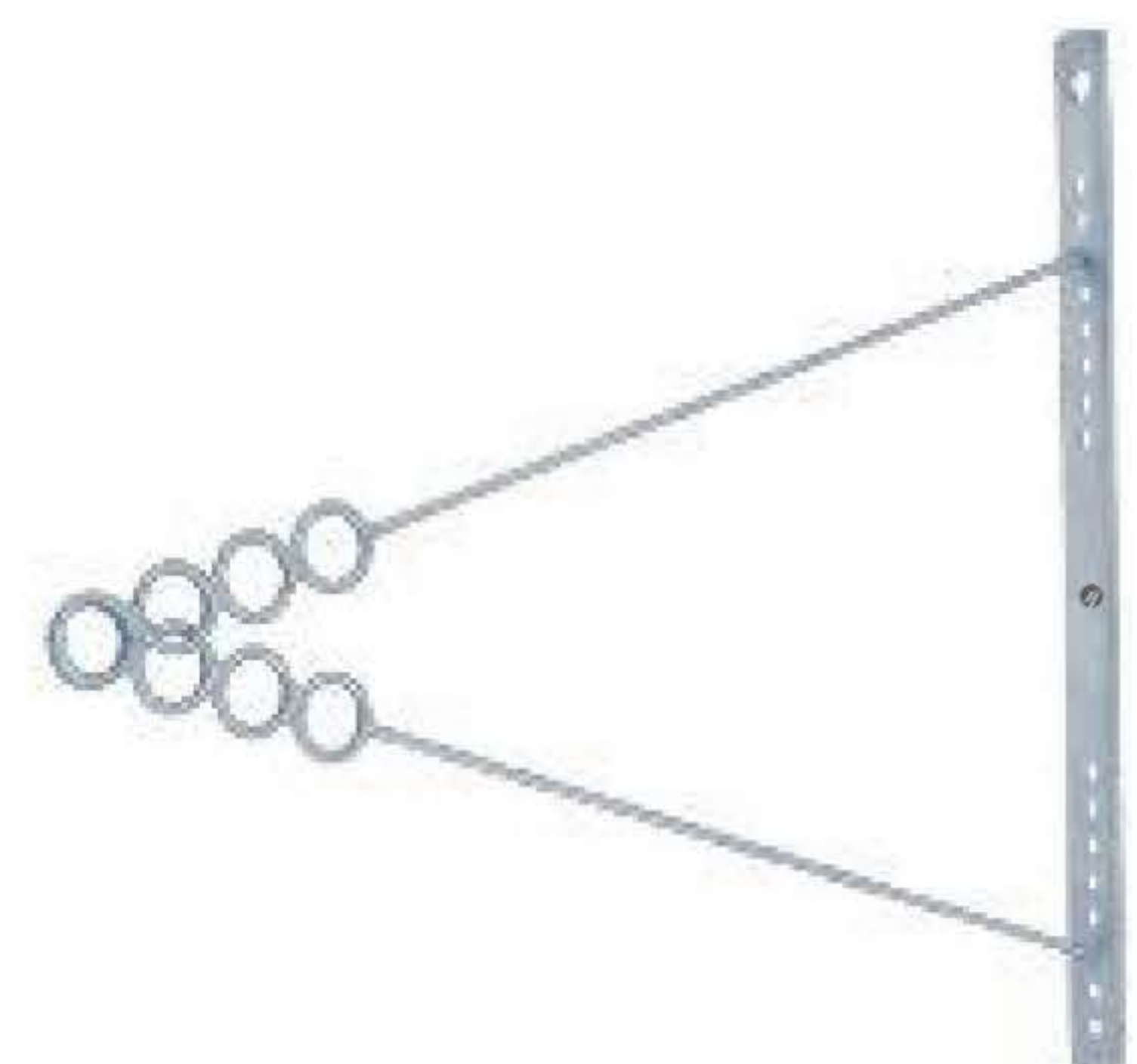

Lip and Cheek Retractors
 Lippen-und Wangenhalter
 Labios y Mejillas Retractores
 Lèvres et jouaux
 Labbra e guance Divaricatori

McKesson Mouth Prop

Catalog #	Profile
OM-110-01	Small
OM-110-02	Medium
OM-110-03	Large

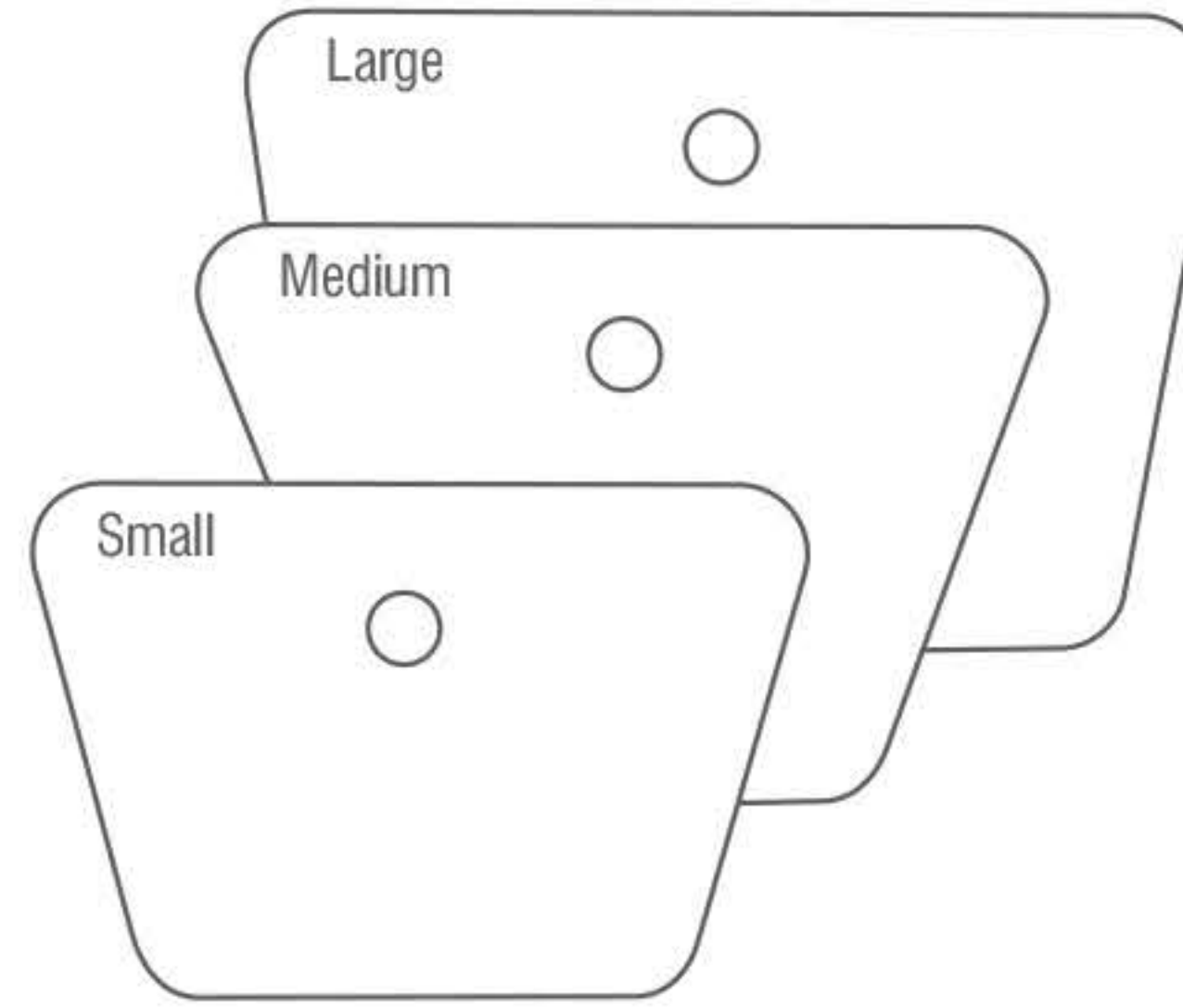

Martin-Simplex Lip and Cheek Retractor

Catalog #	Size
OM-121-11	10 cm (4")



Obwegeser Lip and Cheek Retractor

Catalog #	Size
OM-123-12	10 cm (4 3/4")



Bishop Lip and Cheek Retractor

Catalog #	Size, Blade Width
OM-127-13	13.5 cm (5 1/4"), 27 mm



Cawood-Minnesota Cheek Retractor

Catalog #	Size, Blade Width
OM-131-15	15 cm (6"), 20 mm



Tongue Depressors
 Zungesenker
 Bajalenguas
 Abaisse-langue
 Abbassalingua

Minnesota Cheek Retractor



Catalog #	Size
OM-135-14	14.5 cm (5 3/4")

Hartmann Tongue Depressor



Catalog #	Size, Blade Size
OM-141-15	15 cm (6"), 72 x 23 mm

Tobold Tongue Depressor

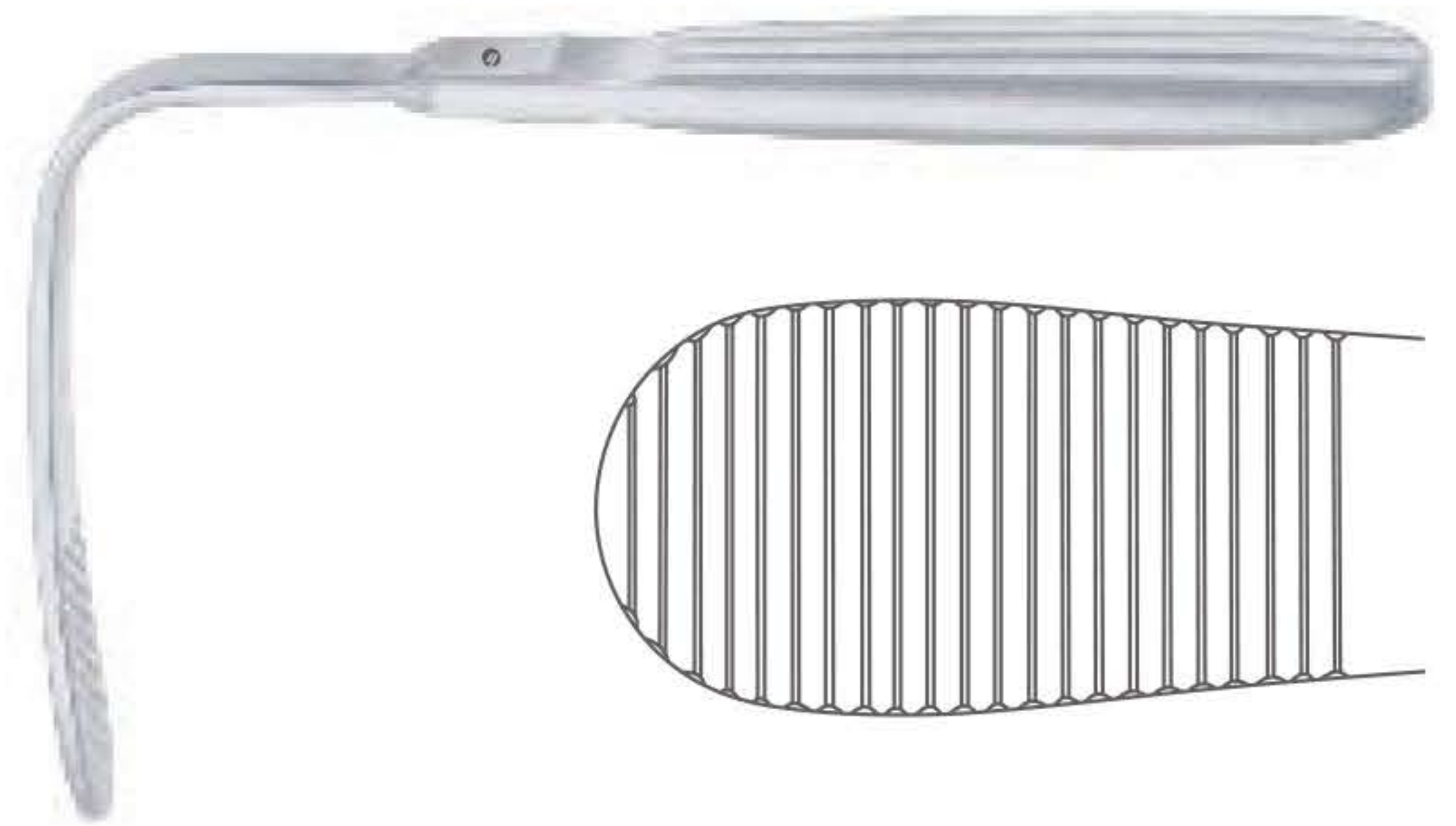

Catalog #	Size, Blade Size
OM-143-15	15 cm (6"), 88 x 25 mm

Andrew Tongue Depressor

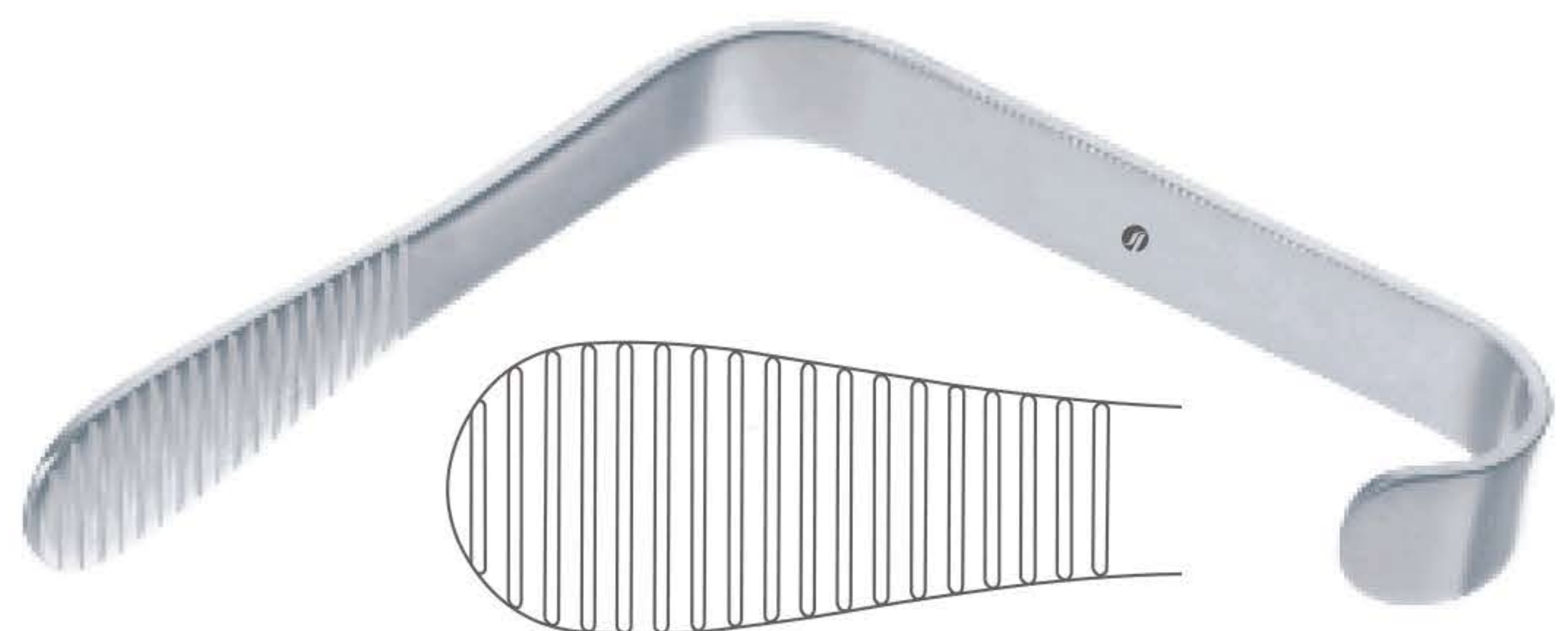

Catalog #	Size
OM-145-14	14.5 cm (5 3/4")

Wieder Tongue Depressor



Catalog #	Size, Blade Width
OM-147-01	14 cm (5 1/2"), 36 mm
OM-147-02	15 cm (6"), 43 mm

OM-147-01

OM-147-02

Tongue Depressors, Tongue Holding Forceps
 Zungesenker, Zungehaltezaugen
 Bajalenguas, Pinza tira-lengua
 Abaisse-langue, Pincés tire-langue
 Abbassalingua, Pinze per lingua

Standard Tongue Depressor



Catalog #	Size
OM-151-14	14.5 cm (5 ¾")

Koenig Tongue Depressor



Catalog #	Size
OM-153-15	15 cm (6")

Mayo Tongue Depressor



Catalog #	Size
OM-155-17	17 cm (6 ¾")

Bruenings Tongue Depressor



Catalog #	Size, Blade Width 1 - Blade Width 2
OM-159-19	19 cm (7 ½"), 19 mm - 15 mm

Collin Tongue Holding Forcep



Catalog #	Size, Jaw Size
OM-170-17	17 cm (6 ¾"), 24 x 27 mm

Tongue Holding Forceps
 Zungehaltezaugen
 Pinza tira-lengua
 Pincès tire-langue
 Pinze per lingua

Young Tongue Holding Forcep



Catalog #	Size
OM-173-17	15 cm (6")

Henahan Retractor

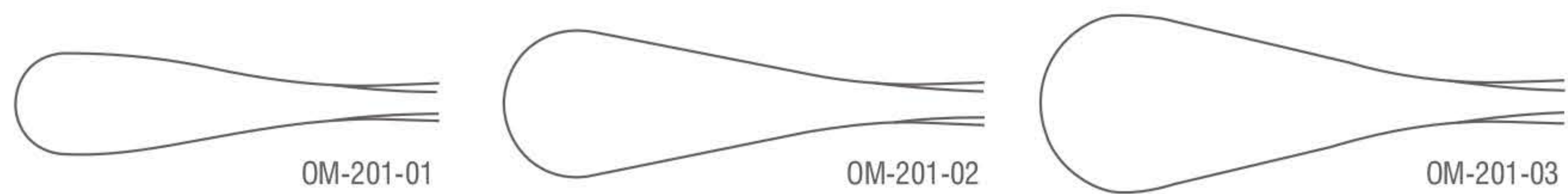

Catalog #	Size, Profile
OM-201-01	18 cm (7"), Fig. 1
OM-201-02	18 cm (7"), Fig. 2
OM-201-03	18 cm (7"), Fig. 3



Sigmoid Notch Extra Oral Retractor
 Concave Blade Full Bent Tip



Catalog #	Size, Blade Size
OM-251-24	22 cm (8 3/4"), 9.5 mm x 16 mm

Petri Intra Oral Retractor
 For LeFort Osteotomies



Catalog #	Size, Blade Width
OM-255-24	23 cm (9"), 25.5 mm

Bauer Intra Oral Retractor
 Left



Catalog #	Size
OM-259-21	21 cm (8 1/4")

Oral Retractors
 Orale Wundhaken
 Separadores orales
 Rétracteurs orales
 Divaricatori orali

Bauer Intra Oral Retractor
 Right



Catalog #	Size
OM-261-21	21 cm (8 ¼")

Levasseur-Merrill Intra Oral Retractor



Catalog #	Size
OM-265-25	25 cm (9 ¾")

Obwegeser Soft Tissue Retractor
 Bent Upwards



Catalog #	Size, Blade Size
OM-271-16	24 cm (9 ½"), 5 x 16 mm
OM-271-25	24 cm (9 ½"), 7 x 25 mm
OM-271-35	24 cm (9 ½"), 10 x 35 mm
OM-271-42	24 cm (9 ½"), 10 x 42 mm
OM-271-55	24 cm (9 ½"), 12 x 55 mm
OM-271-70	24 cm (9 ½"), 14 x 70 mm
OM-271-80	24 cm (9 ½"), 16 x 80 mm

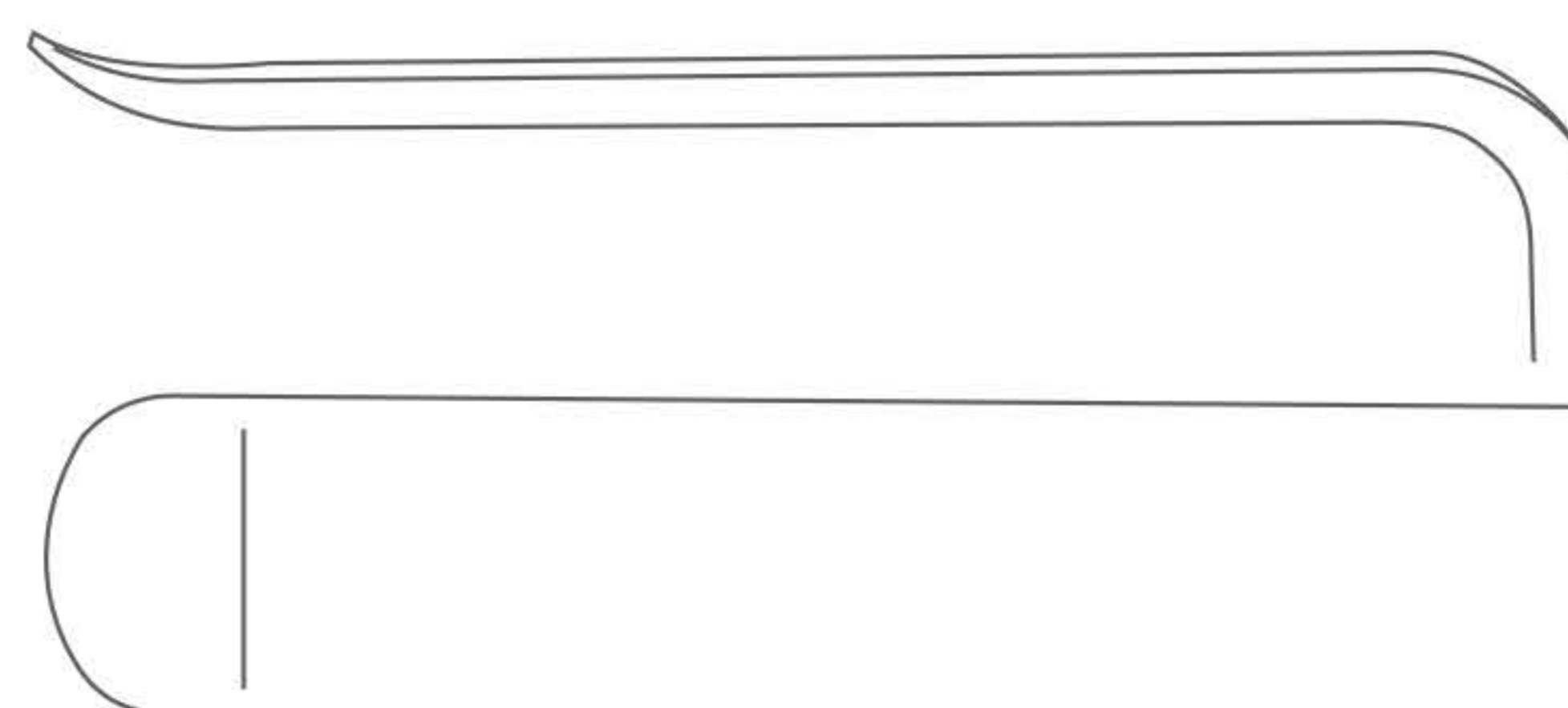

Obwegeser Soft Tissue Retractor
 Bent Downwards



Catalog #	Size, Blade Size
OM-273-16	24 cm (9 ½"), 5 x 16 mm
OM-273-25	24 cm (9 ½"), 7 x 25 mm
OM-273-35	24 cm (9 ½"), 10 x 35 mm
OM-273-42	24 cm (9 ½"), 10 x 42 mm
OM-273-55	24 cm (9 ½"), 12 x 55 mm
OM-273-70	24 cm (9 ½"), 14 x 70 mm
OM-273-80	24 cm (9 ½"), 16 x 80 mm

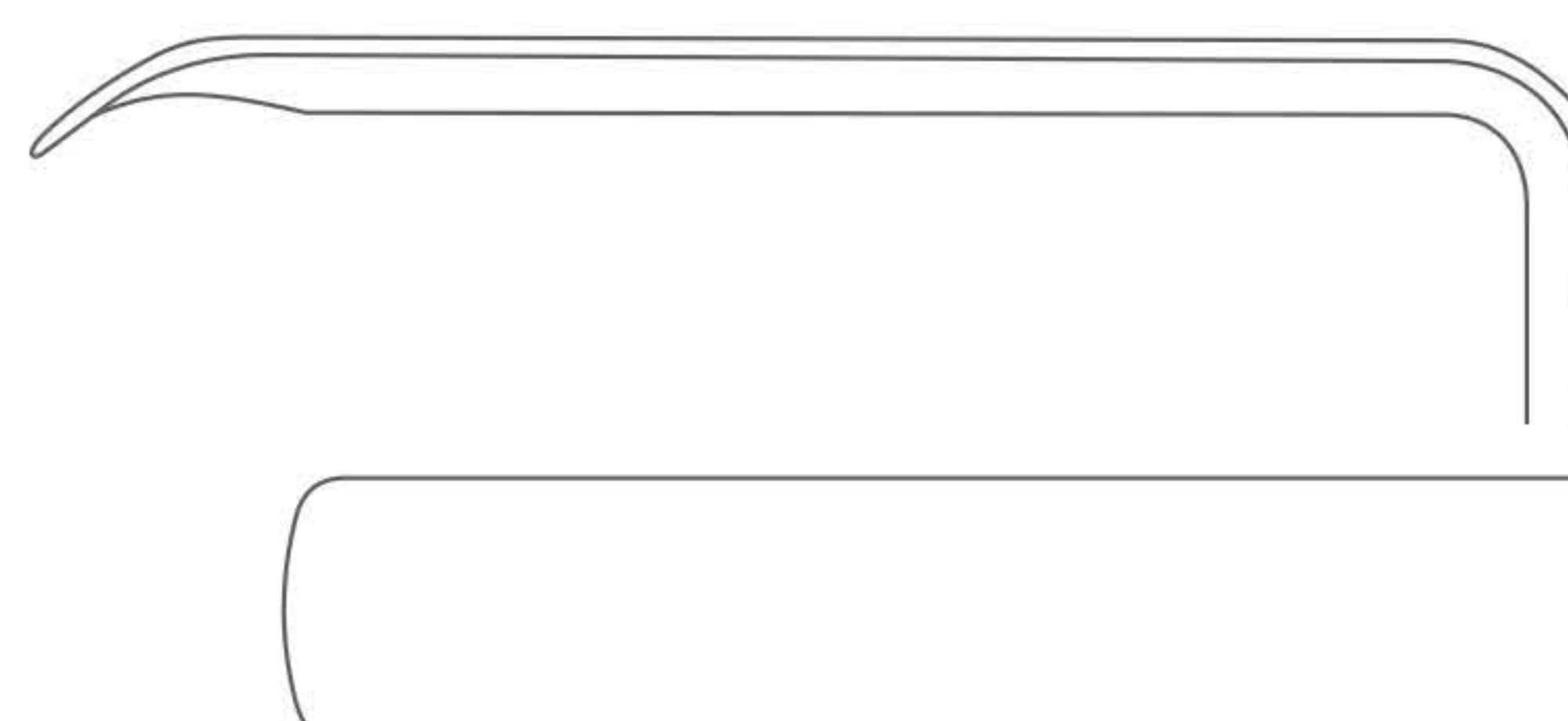

Soft Tissue Retractors
 Weichteilhaken
 Separadores de tejidos blandos
 Rétracteurs des tissus mous
 Divaricatori tessuti molli

Obwegeser Soft Tissue Retractor
 Bent Upwards

Catalog #	Size, Blade Size
OM-275-43	21.5 cm (8 1/2"), 11 x 43 mm
OM-275-57	21.5 cm (8 1/2"), 11 x 57 mm
OM-275-83	21.5 cm (8 1/2"), 16 x 83 mm

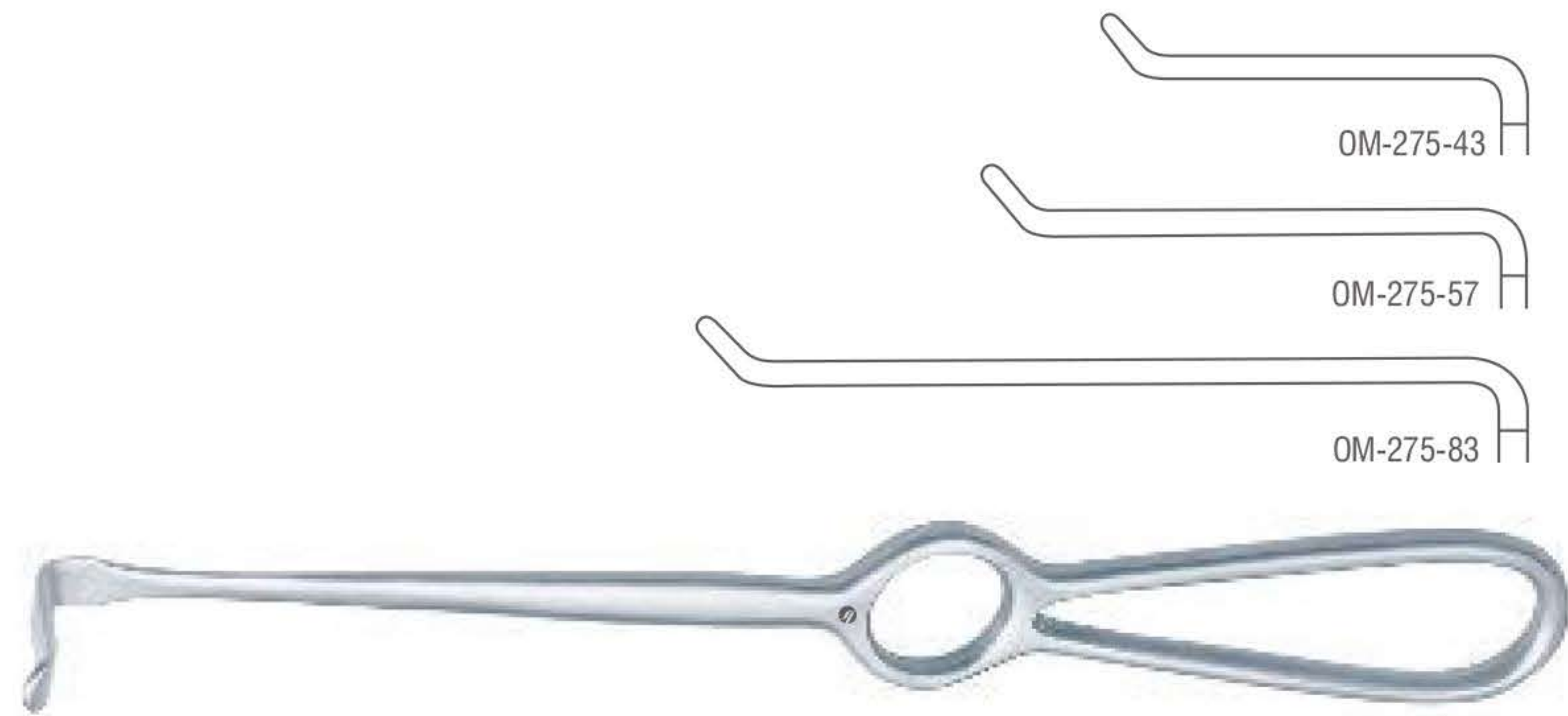

Obwegeser Mandibular Retractor

Catalog #	Size, Blade Size
OM-279-30	21 cm (8 1/4"), 12 x 30 mm
OM-279-45	21 cm (8 1/4"), 12 x 45 mm
OM-279-60	21 cm (8 1/4"), 12 x 60 mm

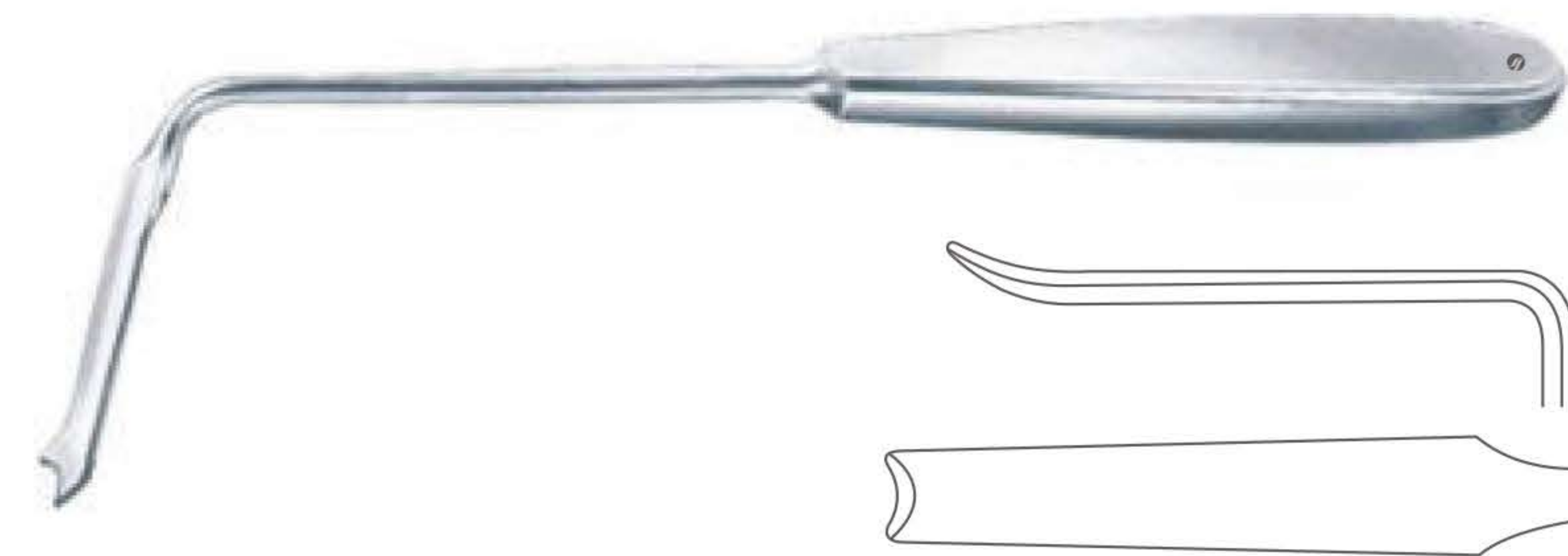

Obwegeser Ramus Retractor

Catalog #	Size, Blade Size
OM-281-22	24.5 cm (9 3/4"), 15 x 70 mm



Obwegeser Ramus Retractor

Catalog #	Size, Blade Size
OM-283-22	24.5 cm (9 3/4"), 22 x 70 mm



Obwegeser Ramus Retractor (Nasal Spine Retractor)

Catalog #	Size, Blade Size
OM-287-22	22 cm (8 3/4"), 45 x 10 mm



Oral Retractors
 Orale Wundhaken
 Separadores orales
 Rétracteurs orales
 Divaricatori orali

Obwegeser Ramus Retractor

Catalog #	Size, Blade Size
OM-289-22	22 cm (8 ¾"), 72 x 10 mm

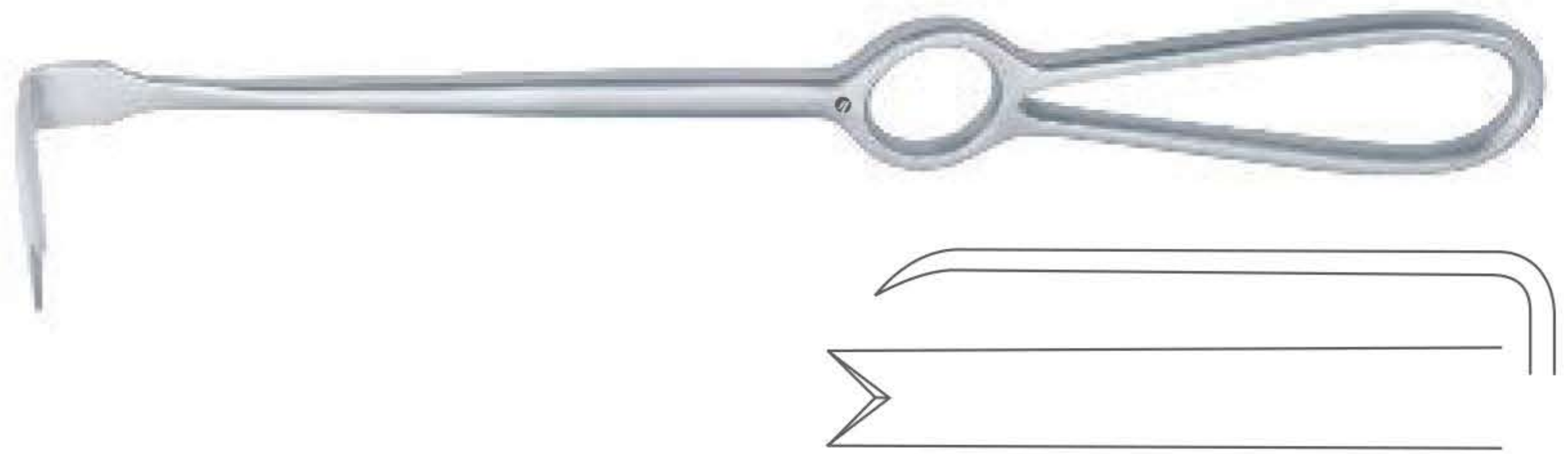

Steinhauser Zygomatic Retractor

Catalog #	Size, Profile
OM-291-01	24 cm (9 ½"), Right
OM-291-02	24 cm (9 ½"), Left

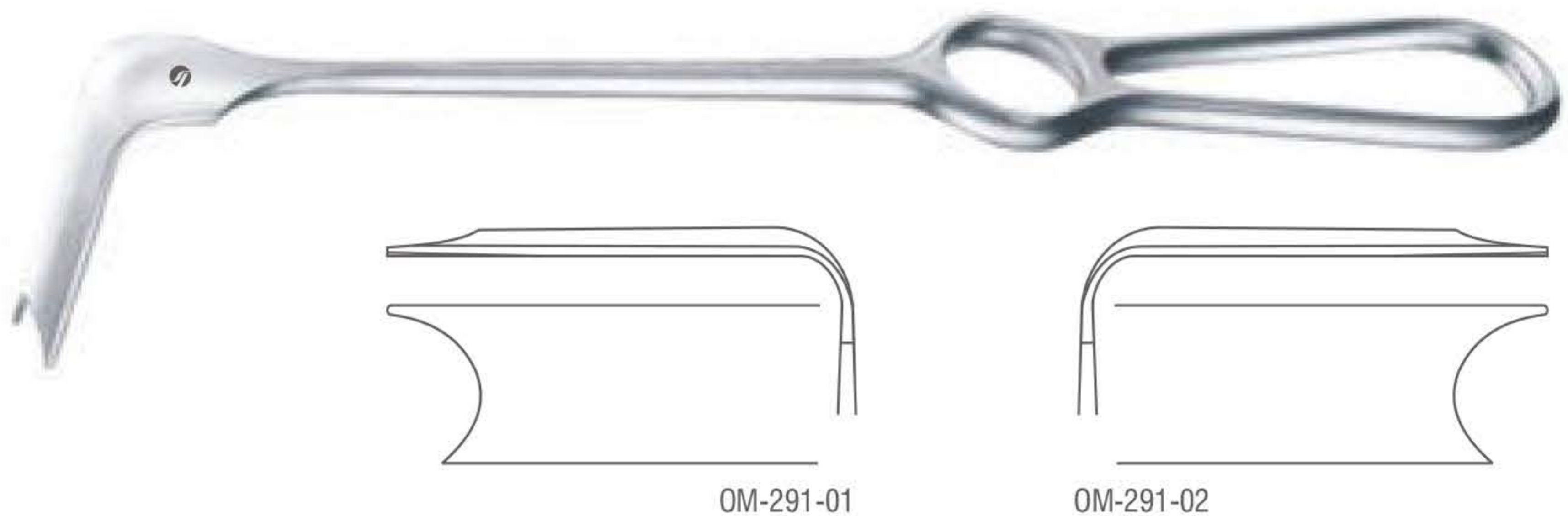

Obwegeser Chin Retractor

Catalog #	Size
OM-301-16	16.5 cm (6 ½")



Obwegeser Channel Retractor

Catalog #	Size, Blade Width
OM-305-08	17 cm (6 ¾"), 8 mm
OM-305-10	17 cm (6 ¾"), 10 mm



Hargis Medial Ramus Retractor

Catalog #	Size, Profile
OM-315-01	19.5 cm (7 ¾"), Right
OM-315-02	19.5 cm (7 ¾"), Left

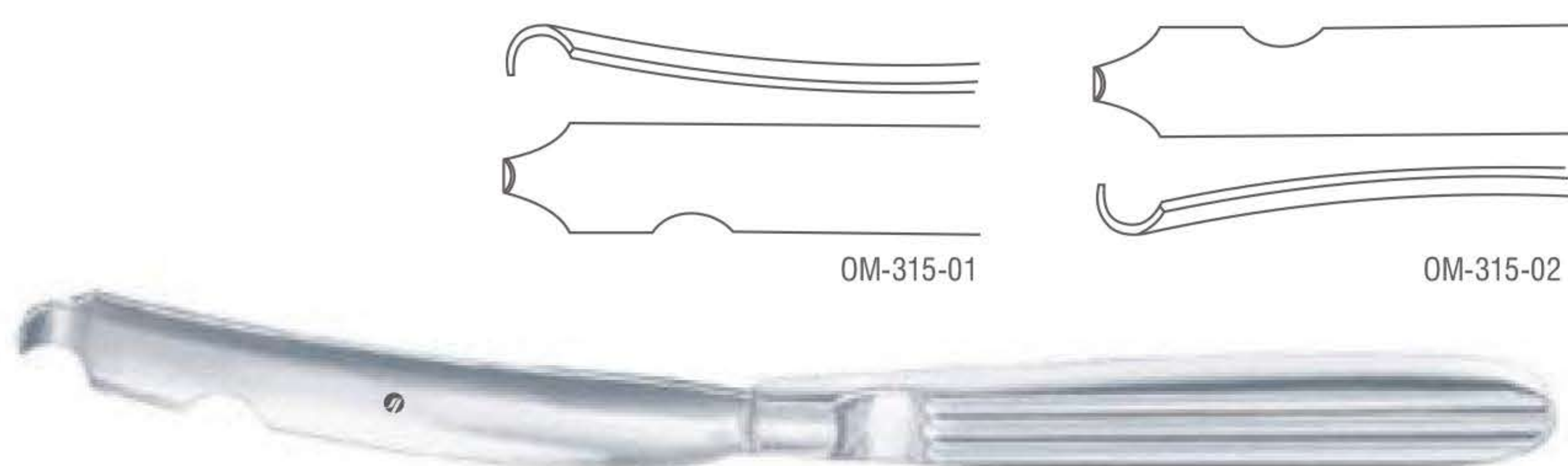

Oral Retractors, Periosteal Elevator
 Orale Wundhaken, Raspatorium
 Separadores orales, Elevador perióstico
 Rétracteurs orales, Ascenseur périostée
 Divaricatori orali, Scollaperiostio

Hargis Mandibular Body Retractor

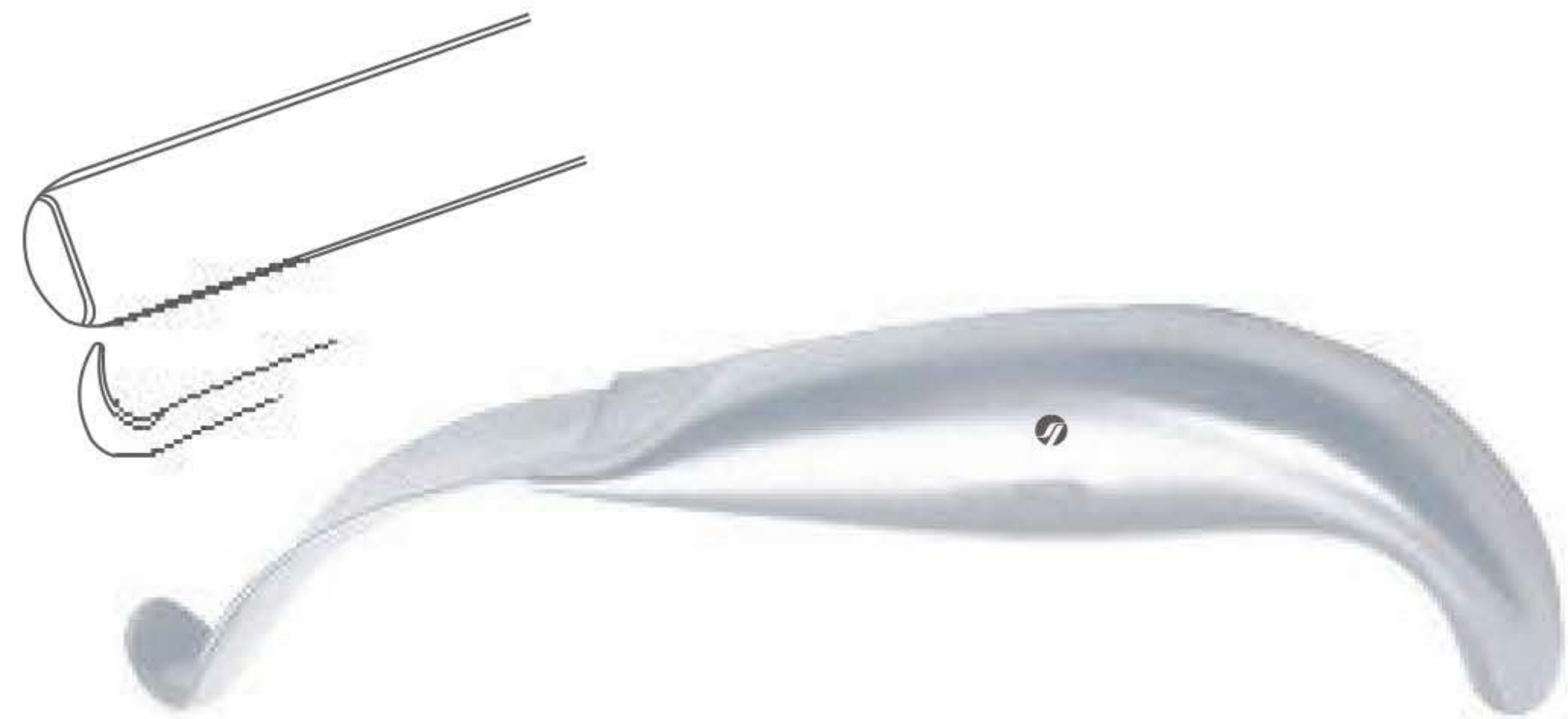

Catalog #	Size
OM-319-18	18 cm (7")

Hargis Anterior Border Stripper



Catalog #	Size
OM-331-19	19 cm (7 1/2")

**Hargis Periosteal Elevator
Right**

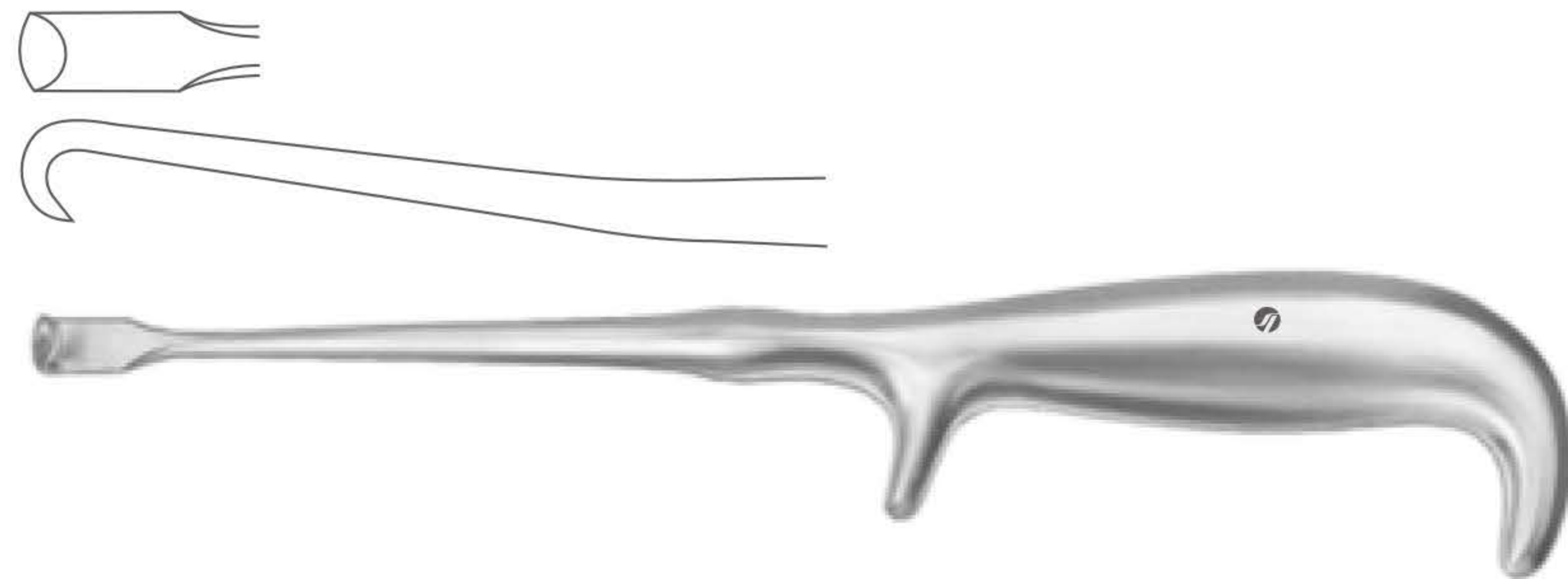

Catalog #	Size, Width
OM-333-06	23 cm (9"), 6.5 mm
OM-333-09	23 cm (9"), 9.0 mm

**Hargis Periosteal Elevator
Left**

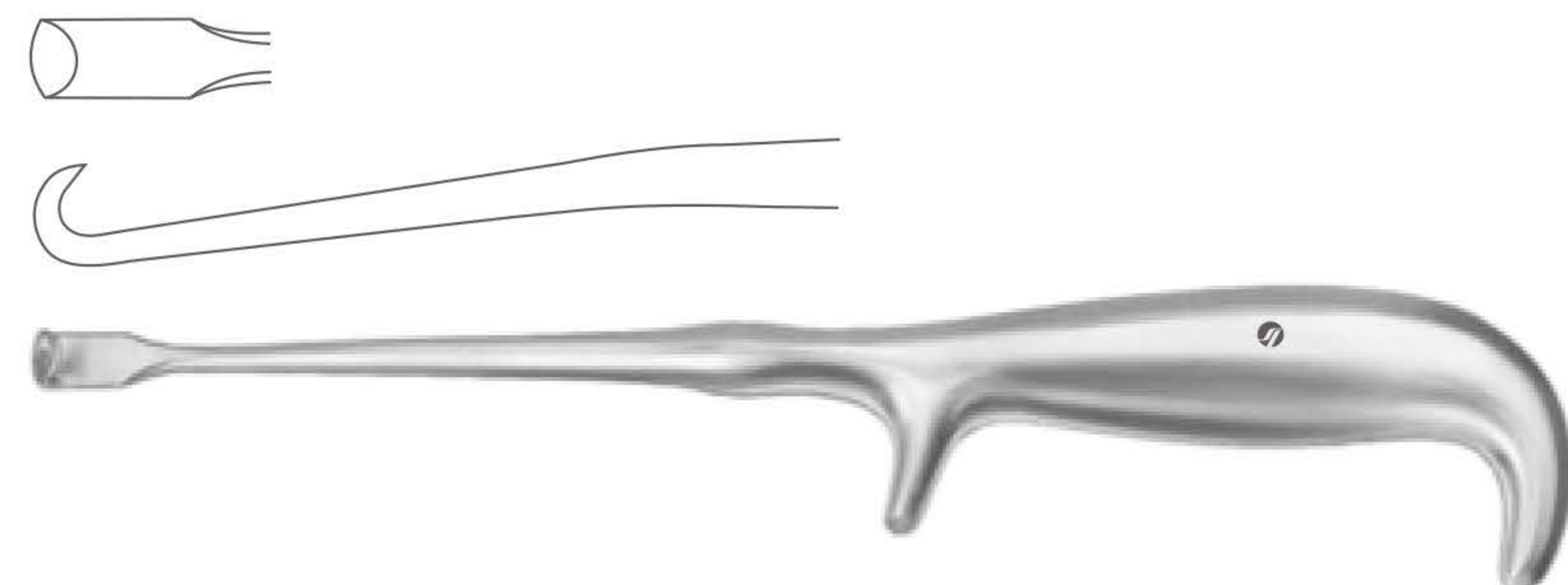

Catalog #	Size, Width
OM-335-06	23 cm (9"), 6.5 mm
OM-335-09	23 cm (9"), 9.0 mm

Hargis Periform Rim Retractor



Catalog #	Size, Width
OM-337-18	18.5 cm (7 1/4")

Periosteal Elevator
 Raspatorium
 Elevador perióstico
 Ascenseur périostée
 Scollaperiostio

Hargis Pterygoid Osteotome



Catalog #	Size, Width
OM-339-22	22 cm (8 3/4")

**Hargis Bone Holding Forcep
 With Chain**

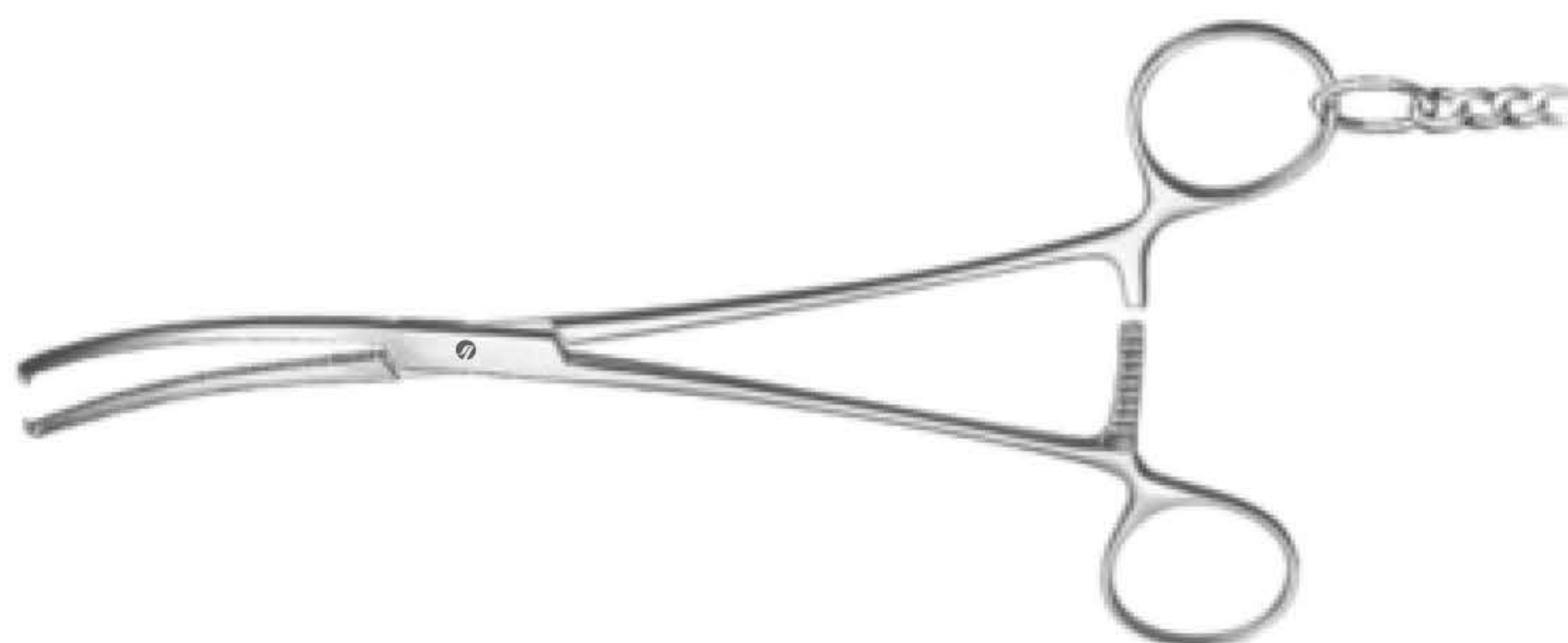

Catalog #	Size, Width
OM-341-19	19 cm (8")

Obwegeser Periosteal Elevator

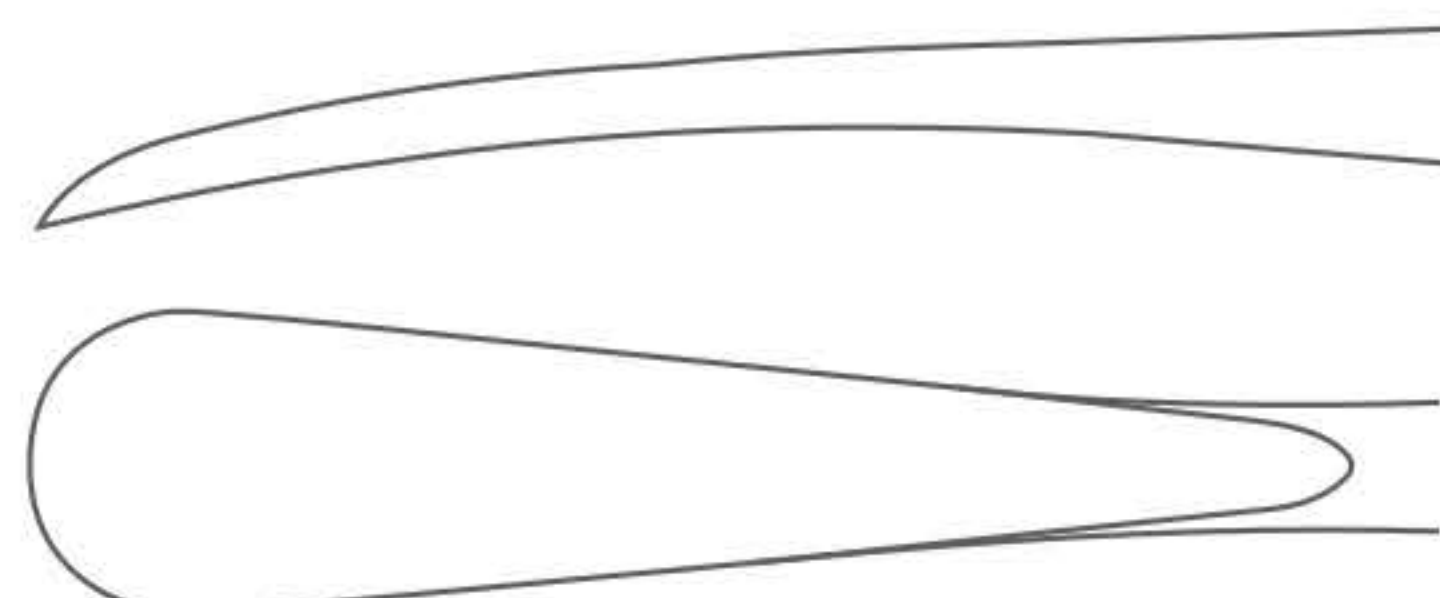

Catalog #	Size, Blade Width
OM-361-04	17.5 cm (7"), 4 mm
OM-361-06	17.5 cm (7"), 6 mm
OM-361-07	17.5 cm (7"), 7 mm
OM-361-09	17.5 cm (7"), 9 mm
OM-361-11	17.5 cm (7"), 11 mm



**Obwegeser Elevator
 Fig. 1**

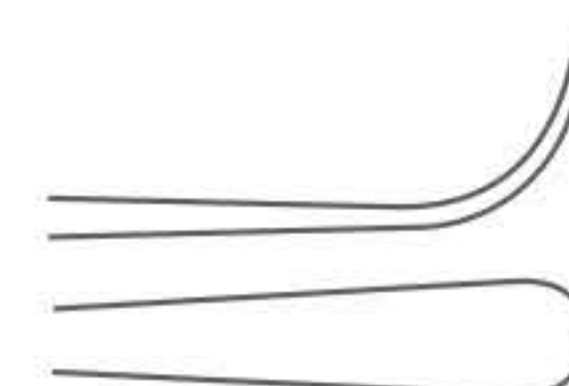

Catalog #	Size
OM-381-21	20.5 cm (8")



**Obwegeser Elevator
 Fig. 2**

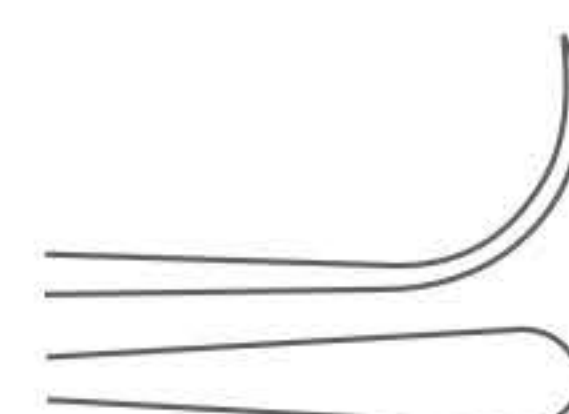

Catalog #	Size
OM-383-21	20.5 cm (8")



Periosteal Elevator
 Raspatorium
 Elevador perióstico
 Ascenseur périostée
 Scollaperiostio

Obwegeser J-Stripper

Catalog #	Size, Blade Width
OM-401-05	20.5 cm (8"), 5 mm
OM-401-07	20.5 cm (8"), 7 mm
OM-401-09	20.5 cm (8"), 9 mm



Obwegeser Ramus Stripper

Catalog #	Size, Profile
OM-405-01	17.5 cm (7"), Fig. 1
OM-405-02	17.5 cm (7"), Fig. 2

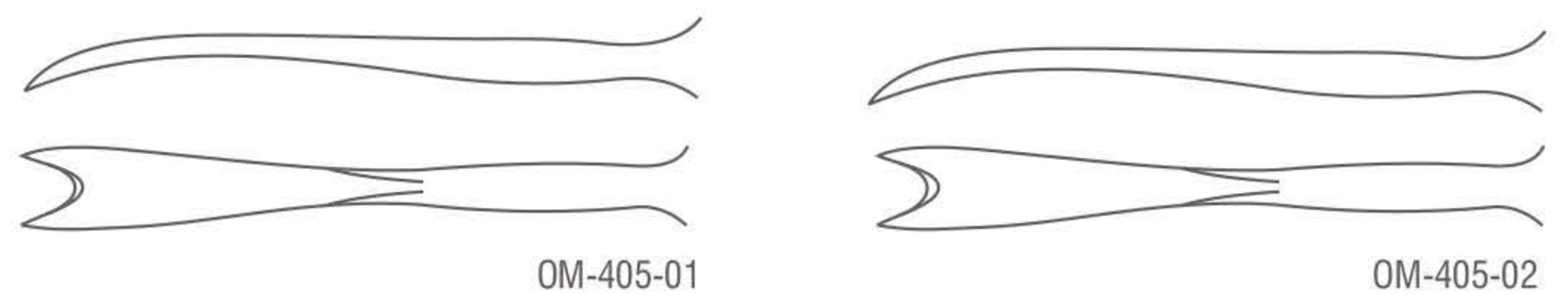

Terry Ramus Pusher

Catalog #	Size
OM-415-24	24 cm (9 1/2")



Steinhauser Reposition Instrument

Catalog #	Size
OM-421-18	18 cm (7")



Tatum Sinus Lift Curette
 Fig. 1

Catalog #	Size, Blade Width
OM-451-01	18 cm (7"), 2.6 mm - 2.6 mm



Sinus Lift Curettes
 Sinus Lift Küretten
 Curetas Sinus Lift
 Curettes Sinus Lift
 Curette rialzo del seno

Tatum Sinus Lift Curette
 Fig. 2



Catalog #	Size, Blade Width
OM-453-02	17.5 cm (7"), 2.6 mm - 2.6 mm

Tatum Sinus Lift Curette
 Fig. 3



Catalog #	Size, Blade Width
OM-455-03	18 cm (7"), 4.1 mm - 4.1 mm

Tatum Sinus Lift Curette
 Fig. 4



Catalog #	Size, Blade Width
OM-457-04	18.5 cm (7 1/4"), 4.1 mm - 4.1 mm

Tatum Sinus Lift Curette
 Fig. 5



Catalog #	Size, Blade Width
OM-459-05	18.5 cm (7 1/4"), 6.7 mm - 6.7 mm

Tatum Sinus Lift Curette
 Fig. 6



Catalog #	Size, Blade Width
OM-461-06	19 cm (7 1/2"), 6.7 mm - 6.7 mm

Sinus Lift Cures, Maxillary Awls
 Sinus Lift Küretten, Unterkieferahlen
 Curetas Sinus Lift, Leznas Maxilares
 Curettes Sinus Lift, Alènes maxillaires
 Curette rialzo del seno, Punteruoli mascellari

Tatum Sinus Lift Curette
 Fig. 7



Catalog #	Size, Blade Width
OM-463-07	16 cm (6 1/4"), 2.8 mm - 6.2 mm

Tatum Sinus Lift Curette
 Fig. 8



Catalog #	Size, Blade Width
OM-465-08	16 cm (6 1/4"), 2.8 mm - 6.2 mm

Tatum Sinus Lift Curette
 Fig. 9



Catalog #	Size, Blade Width
OM-467-09	15 cm (6"), 3.1 mm - 3.1 mm

Tatum Sinus Lift Curette
 Fig. 10



Catalog #	Size, Blade Width
OM-469-10	17 cm (6 3/4"), 5.6 mm - 5.6 mm

Obwegeser Maxillary Awl



Catalog #	Size
OM-501-15	15 cm (6")
OM-501-17	17.5 cm (7")

Sinus Lift Currettes, Sagittal Split Separators, Ramus Separator
 Sinus Lift Küretten, Sagittalspreizer, Spreizzange
 Curetas Sinus Lift, Separadores sagitales, Pinza para separar la rama
 Currettes Sinus Lift, Ecarteurs sagitaux, Pince pour séparer ramus
 Curette rialzo del seno, Separatori sagittali, Pinza per separare il ramo

Obwegeser Zygomatic Arch Awl



Catalog #	Size
OM-503-24	24 cm (9 1/2")

Obwegeser Maxillary Awl



Catalog #	Size
OM-507-18	18 cm (7")

Obwegeser Wire Loop Forcep



Catalog #	Size
OM-540-15	15 cm (6")

Smith Ramus Separator



Catalog #	Size
OM-550-20	23.5 cm (9 1/4")

Smith Sagittal Split Separator



Catalog #	Size, Profile
OM-554-01	18.5 cm (7 1/4"), Right
OM-554-02	18.5 cm (7 1/4"), Left

OM-554-01

OM-554-02

Disimpaction Forcep, Zygoma Elevators
 Repositionszangen, Zygoma-Elevatoren
 Pinzas para reposición, Elevadores, cigomáticos
 Pinces de reposition, Elévateurs zygommatiques
 pinze per riduzione, Elevatori per zigomo

Rowe Disimpaction Forcep

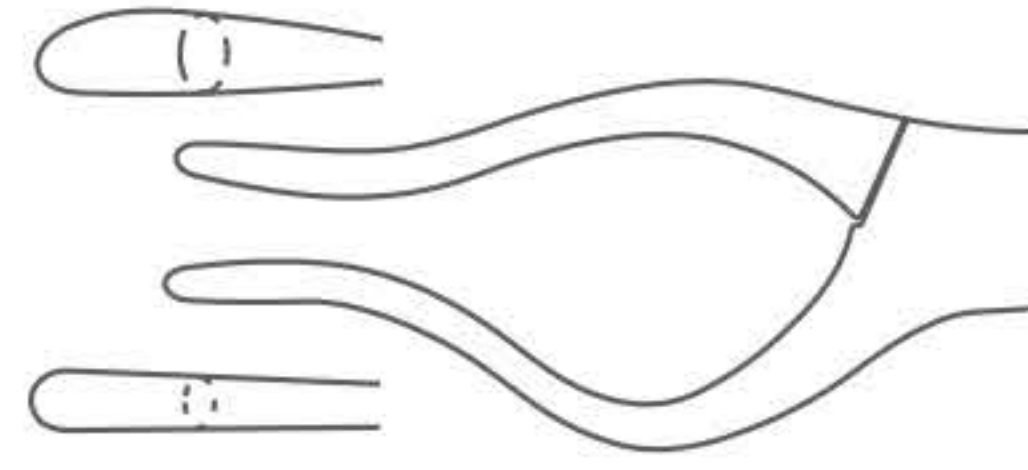

Catalog #	Size, Profile
OM-570-01	22.5 cm (8 ¾”), Left

Rowe Disimpaction Forcep

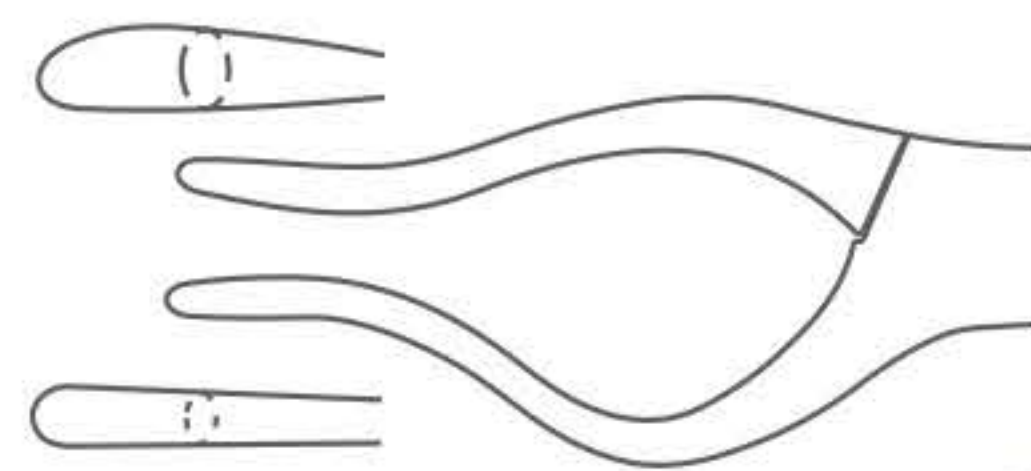

Catalog #	Size, Profile
OM-570-02	22.5 cm (8 ¾”), Right

Gillies Zygoma Elevator

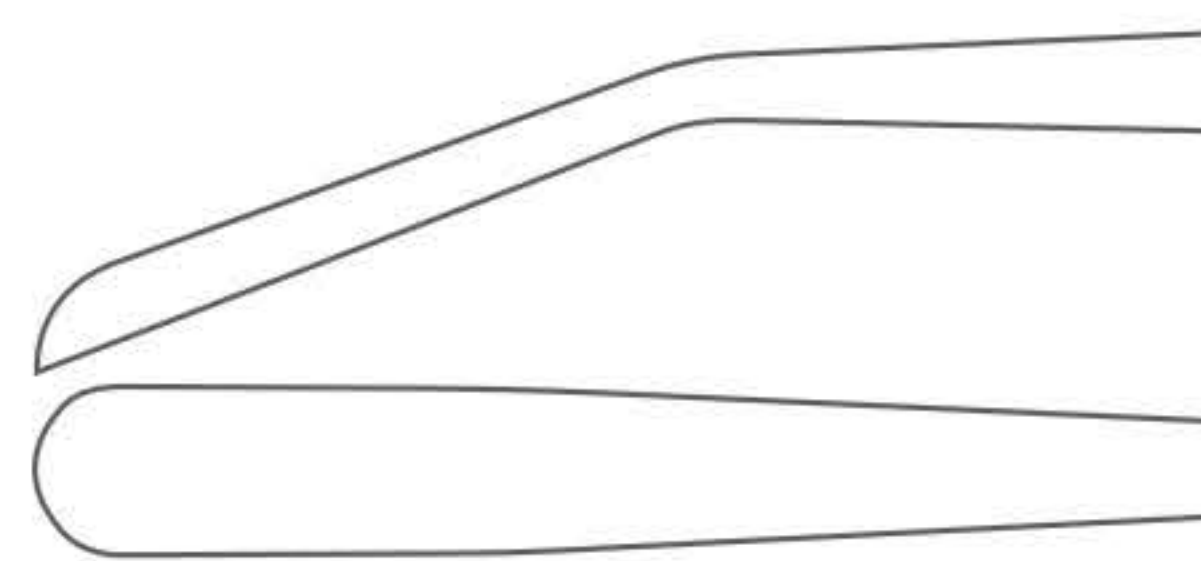

Catalog #	Size
OM-601-21	20 cm (8”)

Dingmann Zygoma Elevator



Catalog #	Size, Tip Diameter
OM-602-21	21 cm (8 ¼”), Ø 5.0 mm

Rowe Zygoma Elevator



Catalog #	Size
OM-605-21	21.5 cm (8 ½”)

Osteotomes
 Osteotome
 Osteótomos
 Ostéotomes
 Osteotomi

Boise Nasal Fracture Elevator

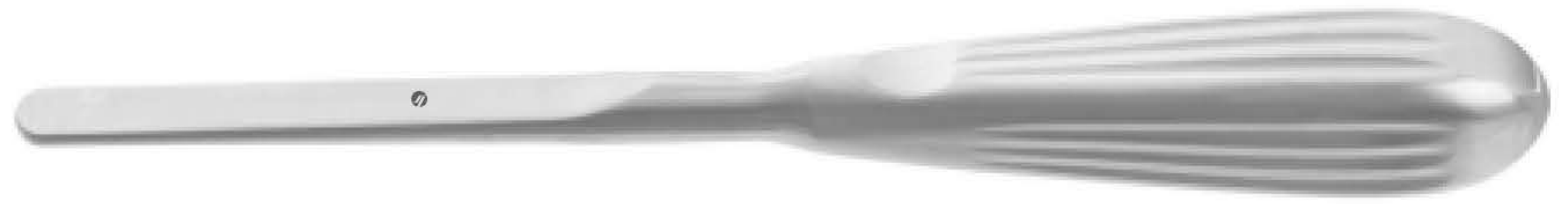

Catalog #	Size, Tip Size
OM-607-19	19.5 cm (7 3/4")

Dingman Bone Hook

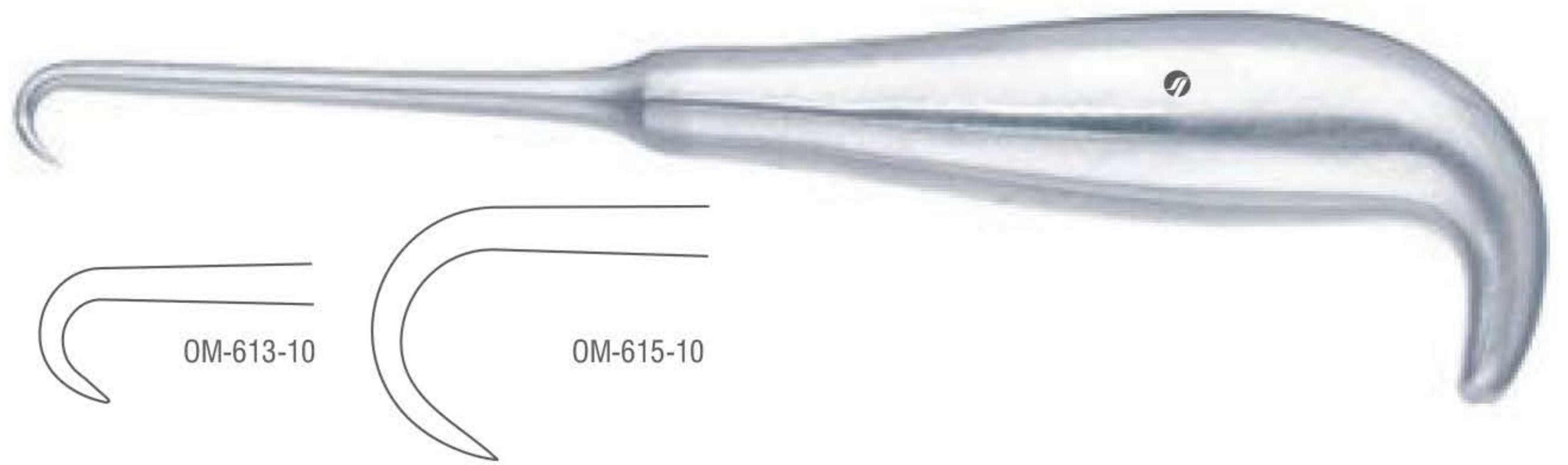

Catalog #	Size, Tip Size
OM-613-10	20 cm (8"), 10 mm
OM-615-10	20 cm (8"), 20 mm

Bauer Osteotome
 Straight



Catalog #	Size, Width
OM-620-06	20.5 cm (8"), 6 mm
OM-620-08	20.5 cm (8"), 8 mm

Bauer Osteotome
 Curved



Catalog #	Size, Width
OM-621-06	20.5 cm (8"), 6 mm
OM-621-08	20.5 cm (8"), 8 mm

Epker-Bauer Osteotome
 Curved



Catalog #	Size, Width
OM-623-08	17.5 cm (7"), 8 mm

Osteotomes
 Osteotome
 Osteótomos
 Ostéotomes
 Osteotomi

Dautrey-Munro Osteotome

Catalog #	Size, Width
OM-626-04	16 cm (6 ¼"), 4.0 mm
OM-626-06	16 cm (6 ¼"), 6.0 mm
OM-626-08	16 cm (6 ¼"), 8.0 mm
OM-626-10	16 cm (6 ¼"), 10.0 mm
OM-626-12	16 cm (6 ¼"), 12.0 mm
OM-626-14	16 cm (6 ¼"), 14.0 mm
OM-626-16	16 cm (6 ¼"), 16.0 mm



**Dunn-Dautrey Osteotome
 Straight**

Catalog #	Size, Width
OM-628-04	16.5 cm (6 ½"), 4.0 mm
OM-628-06	16 cm (6 ¼"), 6.0 mm
OM-628-08	16 cm (6 ¼"), 8.0 mm



**Dunn-Dautrey Osteotome
 Slightly Curved**

Catalog #	Size, Width
OM-629-06	16 cm (6 ¼"), 6.0 mm

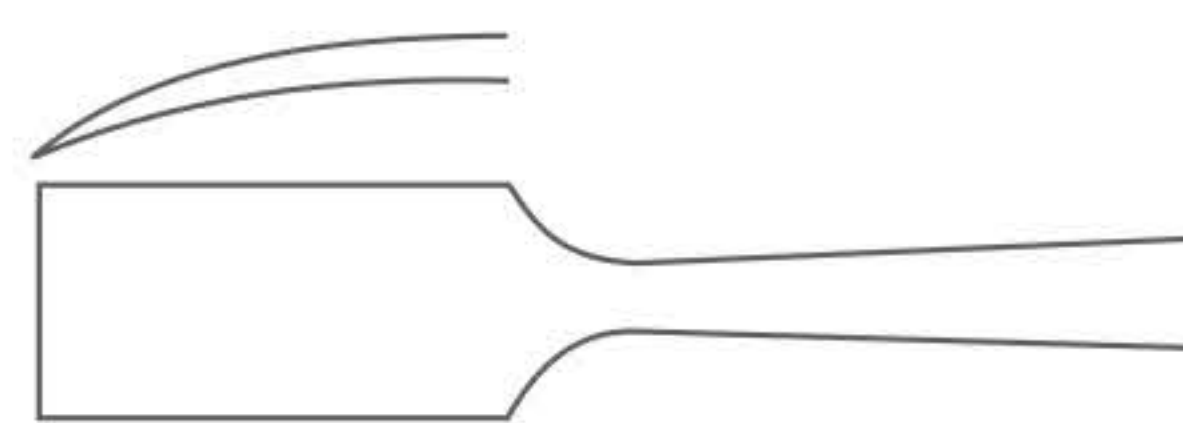

**Dunn-Dautrey Osteotome
 Strongly Curved**

Catalog #	Size, Width
OM-631-06	16 cm (6 ¼"), 6.0 mm

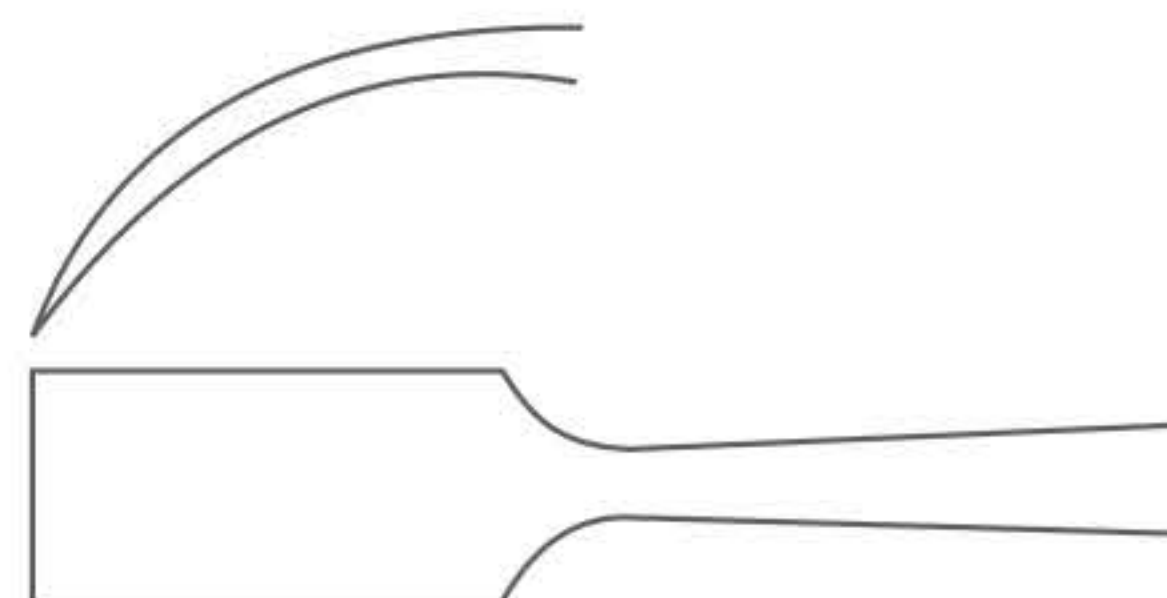

Maxillofacial Instruments
 MKG-Instrumente
 Instrumentos Maxilofaciales
 Instruments Maxilla
 Maxillofacciali Instruments

Dunn-Dautrey Elevator

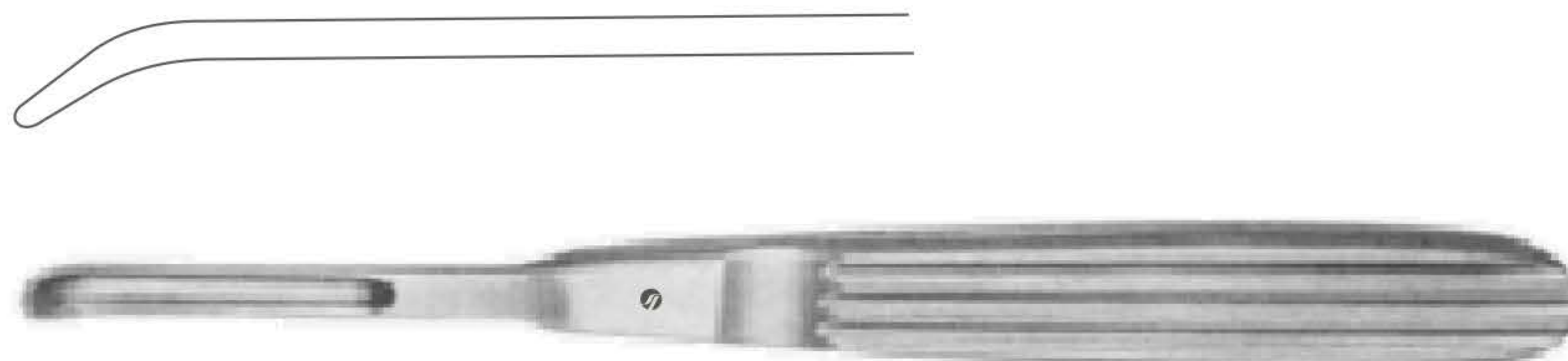

Catalog #	Size, Blade Size
OM-633-48	15.5 cm (6"), 6 x 48 mm
OM-633-56	15.5 cm (6"), 6 x 56 mm

Dolwick-Type TMJ Disc Clamp



Catalog #	Size
OM-637-12	12 cm (4 3/4")

Dolwick-Type TMJ Condylar Retractor



Catalog #	Size
OM-639-14	14.5 cm (5 1/2")

Dolwick-Type TMJ Elevator



Catalog #	Size
OM-641-17	16 cm (6 3/4")

Turvey Palatal Expander

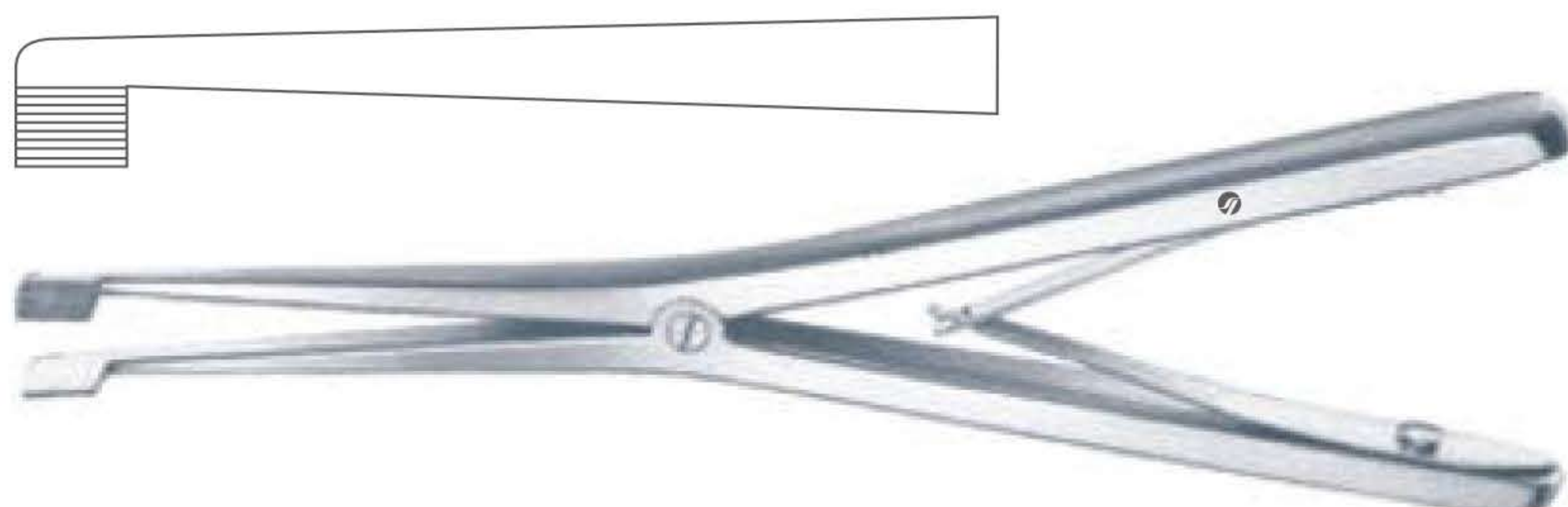

Catalog #	Size
OM-700-17	17 cm (6 3/4")

Osteotomes
Osteotome
Osteótomos
Ostéotomes
Osteotomi

Terry Septal Osteotome

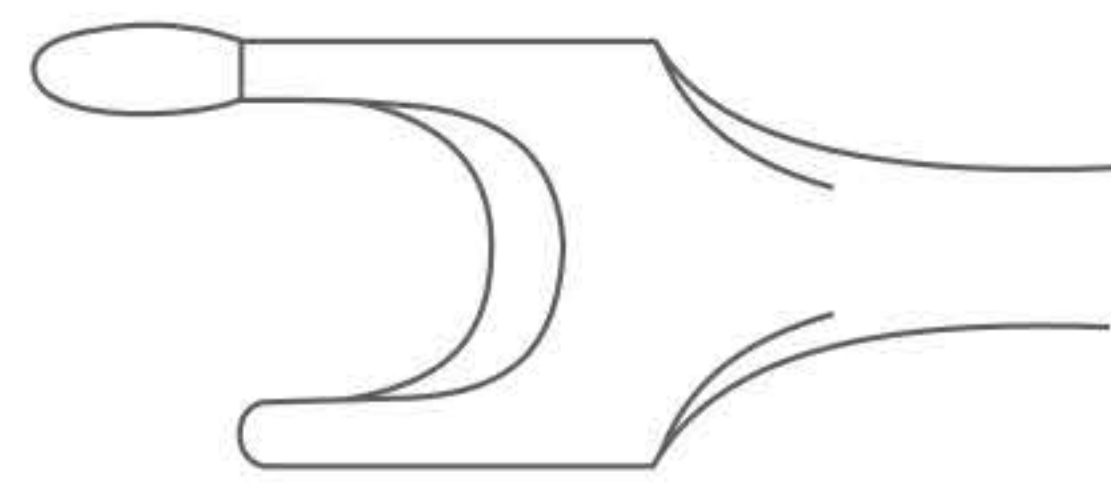

Catalog #	Size
OM-730-19	19 cm (7 1/2")



Obwegeser Septonasal Osteotome Graduated

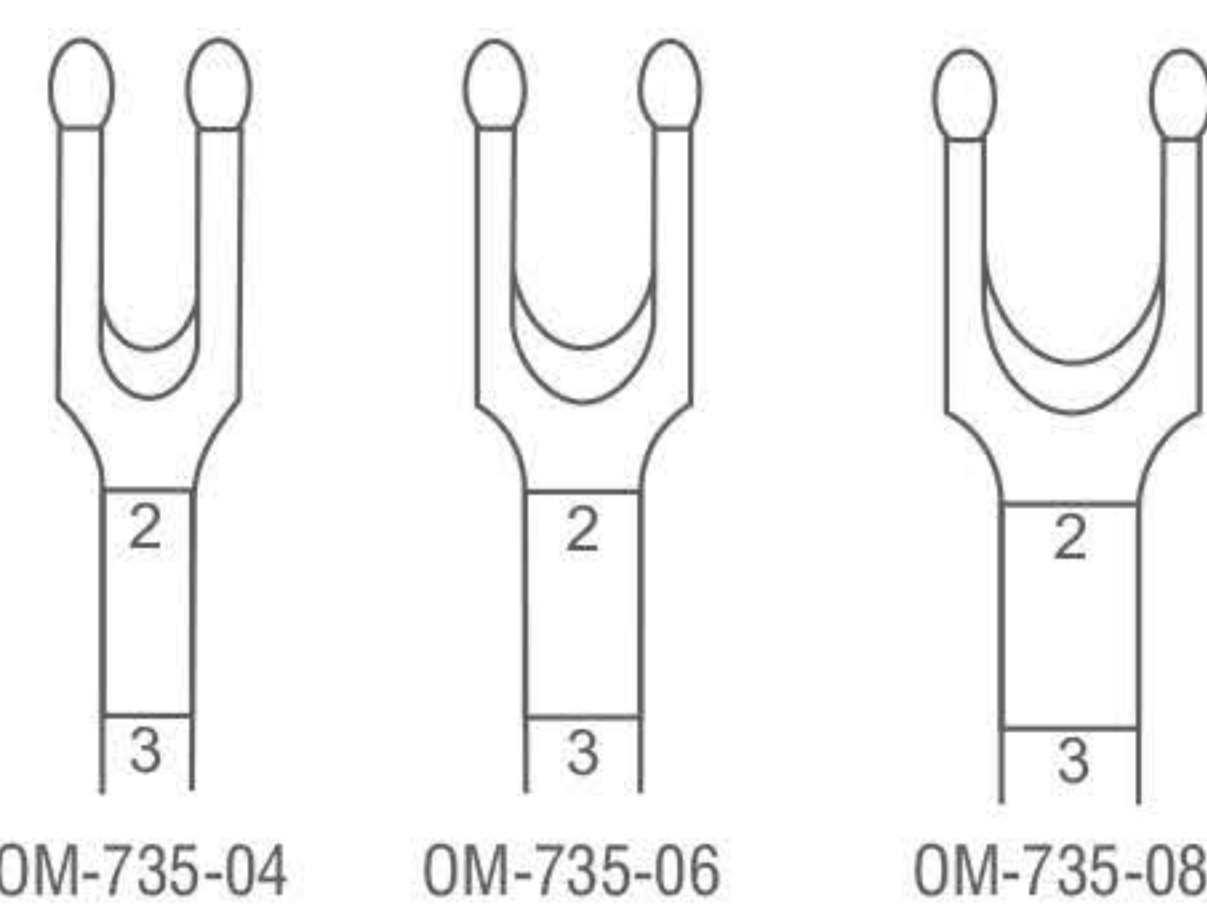

Catalog #	Size, Blade Width
OM-735-04	18.5 cm (7 1/4"), 4 mm
OM-735-06	18.5 cm (7 1/4"), 6 mm
OM-735-08	18.5 cm (7 1/4"), 8 mm



FiberGrip™ Obwegeser Wedge Osteotome

FIBERGrip™

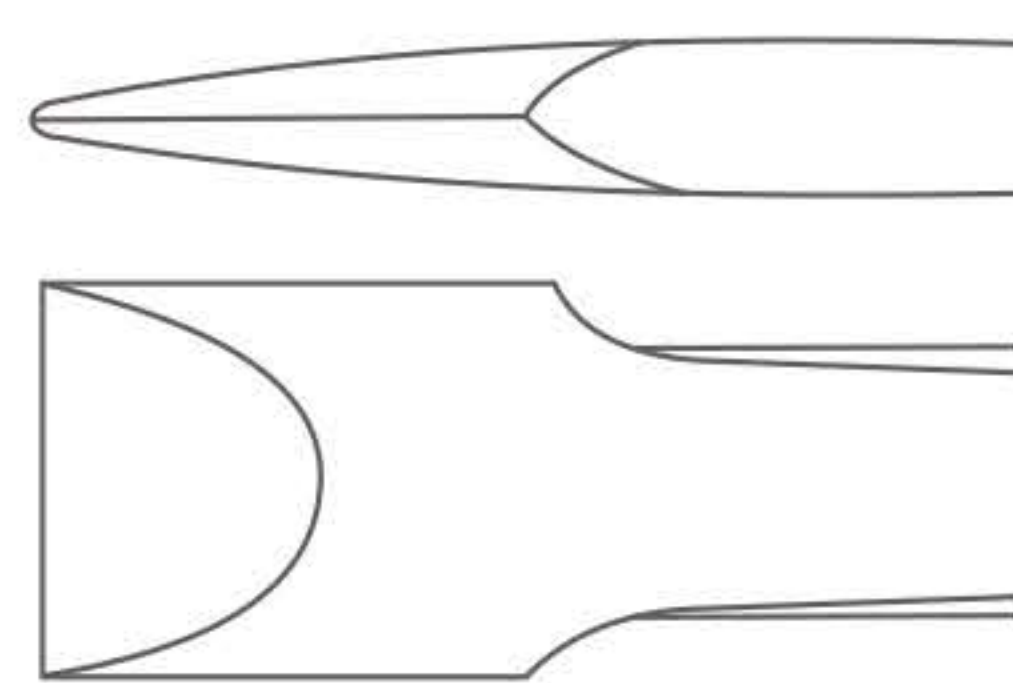

Catalog #	Size, Blade Width
OM-740-08	22 cm (8 3/4"), 8 mm
OM-740-12	22 cm (8 3/4"), 12 mm
OM-747-16	22 cm (8 3/4"), 16 mm



FiberGrip™ Obwegeser Split Osteotome

FIBERGrip™

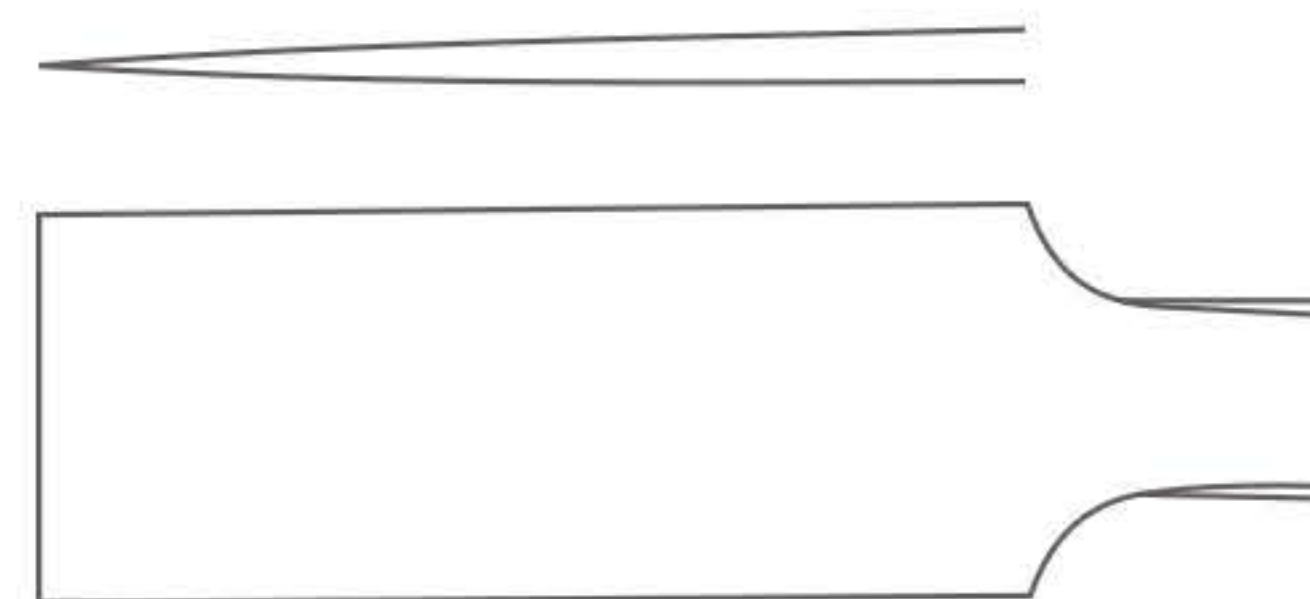

Catalog #	Size, Blade Width
OM-742-08	22 cm (8 3/4"), 8 mm
OM-742-12	22 cm (8 3/4"), 12 mm
OM-742-16	22 cm (8 3/4"), 16 mm
OM-742-20	22 cm (8 3/4"), 20 mm



Osteotomes
 Osteotome
 Osteótomos
 Ostéotomes
 Osteotomi

Obwegeser Osteotome
 For Alveolar Process

Catalog #	Size, Blade Width
OM-750-03	15 cm (6"), 3 mm
OM-750-04	15 cm (6"), 4 mm
OM-750-06	15 cm (6"), 6 mm



Ear Specula
 Ohrspekula
 Espéculos auriculares
 Spéculums auriculaires
 Specoli auricolari

Hartmann Ear Specula

Set of 3 Ref: OT-012-00 to OT-012-02

Catalog #	Size
OT-010-01	Standard



Hartmann Ear Specula

Set of 3 Ref: OT-012-02 to OT-012-04

Catalog #	Size
OT-010-02	Standard



Hartmann Ear Specula

Set of 3 Ref: OT-012-01 to OT-012-04

Catalog #	Size
OT-010-03	Standard



Hartmann Ear Specula

Set of 3 Ref: OT-012-00 to OT-012-04

Catalog #	Size
OT-010-03	Standard



Hartmann Ear Speculum

Catalog #	Size, Diameter, Profile
OT-012-00	3.6 cm (1 1/2"), Ø 3.0 mm, Fig. 0
OT-012-01	3.6 cm (1 1/2"), Ø 4.0 mm, Fig. 1
OT-012-02	3.6 cm (1 1/2"), Ø 5.0 mm, Fig. 2
OT-012-03	3.6 cm (1 1/2"), Ø 6.0 mm, Fig. 3
OT-012-04	3.6 cm (1 1/2"), Ø 7.0 mm, Fig. 4



Ear Specula
 Ohrspekula
 Espéculos auriculares
 Spéculums auriculaires
 Specoli auricolari

Toynbee Ear Specula

Set of 3 Ref: OT-022-02 to OT-022-04

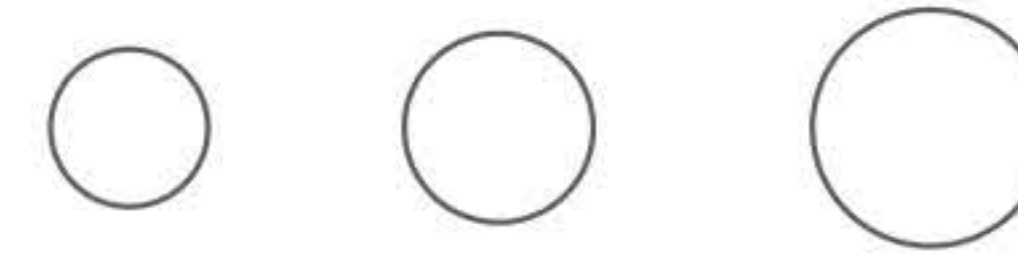

Catalog #	Size
OT-020-01	Standard



Toynbee Ear Specula

Set of 4 Ref: OT-022-01 to OT-022-04



Catalog #	Size
OT-020-02	Standard



Toynbee Ear Speculum

For Adults

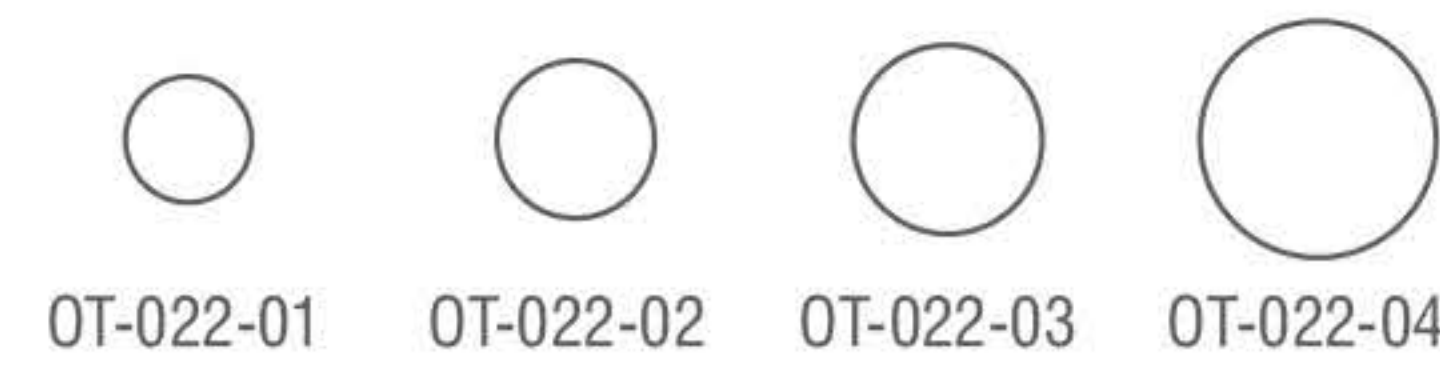

Catalog #	Size
OT-022-01	3.6 cm (1 1/2"), Ø 4.0 mm, Fig. 1
OT-022-02	3.6 cm (1 1/2"), Ø 5.0 mm, Fig. 2
OT-022-03	3.6 cm (1 1/2"), Ø 6.0 mm, Fig. 3
OT-022-04	3.6 cm (1 1/2"), Ø 7.0 mm, Fig. 4



Hartmann Ear Specula (Black)

Set of 3 Ref: OT-032-00 to OT-032-02

Catalog #	Size
OT-030-01	Standard



Hartmann Ear Specula (Black)

Set of 3 Ref: OT-032-02 to OT-032-04

Catalog #	Size
OT-030-02	Standard



Ear Specula
 Ohrspekula
 Espéculos auriculares
 Spéculums auriculaires
 Specoli auricolari

Hartmann Ear Specula (Black)
 Set of 4 Ref: OT-032-01 to OT-032-04

Catalog #	Size
OT-030-03	Standard



Hartmann Ear Speculum
 Black

Catalog #	Size, Profile
OT-032-00	3.6 cm (1 1/2"), Fig. 0
OT-032-01	3.6 cm (1 1/2"), Fig. 1
OT-032-02	3.6 cm (1 1/2"), Fig. 2
OT-032-03	3.6 cm (1 1/2"), Fig. 3
OT-032-04	3.6 cm (1 1/2"), Fig. 4



Zoellner Ear Specula
 Set of 6 Ref: OT-042-01 to OT-042-06

Catalog #	Size
OT-040-01	Standard

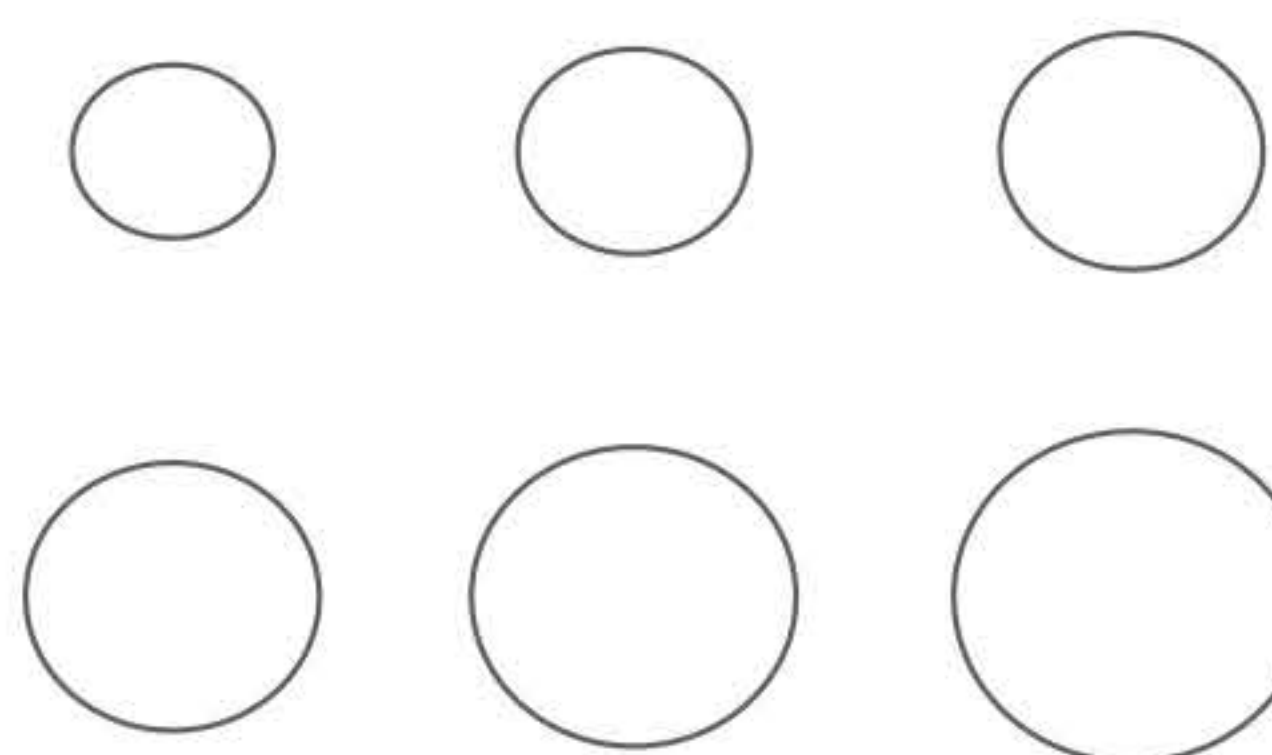

Zoellner Ear Speculum
 Oval, Black

Catalog #	Size, Tip Size, Profile
OT-042-01	3.8 cm (1 1/2"), 5.5 x 6.5 mm. Fig. 1
OT-042-02	3.8 cm (1 1/2"), 6.5 x 7.5 mm. Fig. 2
OT-042-03	3.8 cm (1 1/2"), 7.5 x 8.5 mm. Fig. 3
OT-042-04	3.8 cm (1 1/2"), 8.5 x 9.5 mm. Fig. 4
OT-042-05	3.8 cm (1 1/2"), 9.5 x 10.5 mm. Fig. 5
OT-042-06	3.8 cm (1 1/2"), 10.5 x 11.5 mm. Fig. 6

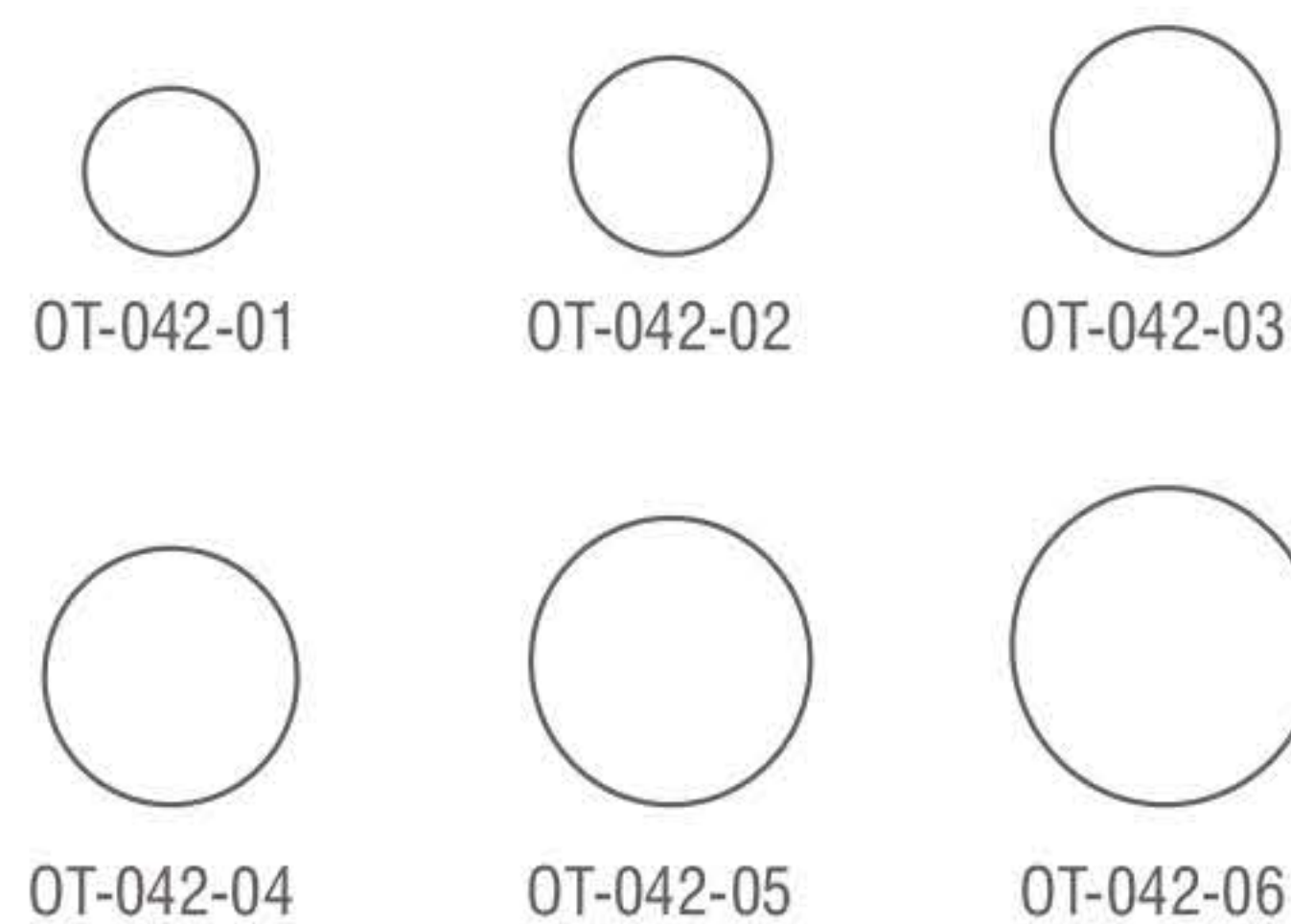

Ear Specula
 Ohrspekula
 Espéculos auriculares
 Spéculums auriculaires
 Specoli auricolari

Farrior Ear Specula
 Set of 7 Ref: OT-052-01 to OT-052-07

Catalog #	Size
OT-050-01	Standard



Farrior Ear Speculum
 Black

Catalog #	Size, Diameter, Profile
OT-052-01	3.6 cm (1 1/2"), Ø 5.5 mm, Fig. 1
OT-052-02	3.6 cm (1 1/2"), Ø 6.5 mm, Fig. 2
OT-052-03	3.6 cm (1 1/2"), Ø 7.5 mm, Fig. 3
OT-052-04	3.6 cm (1 1/2"), Ø 8.5 mm, Fig. 4
OT-052-05	3.6 cm (1 1/2"), Ø 9.5 mm, Fig. 5
OT-052-06	3.6 cm (1 1/2"), Ø 10.5 mm, Fig. 6
OT-052-07	3.6 cm (1 1/2"), Ø 11.5 mm, Fig. 7

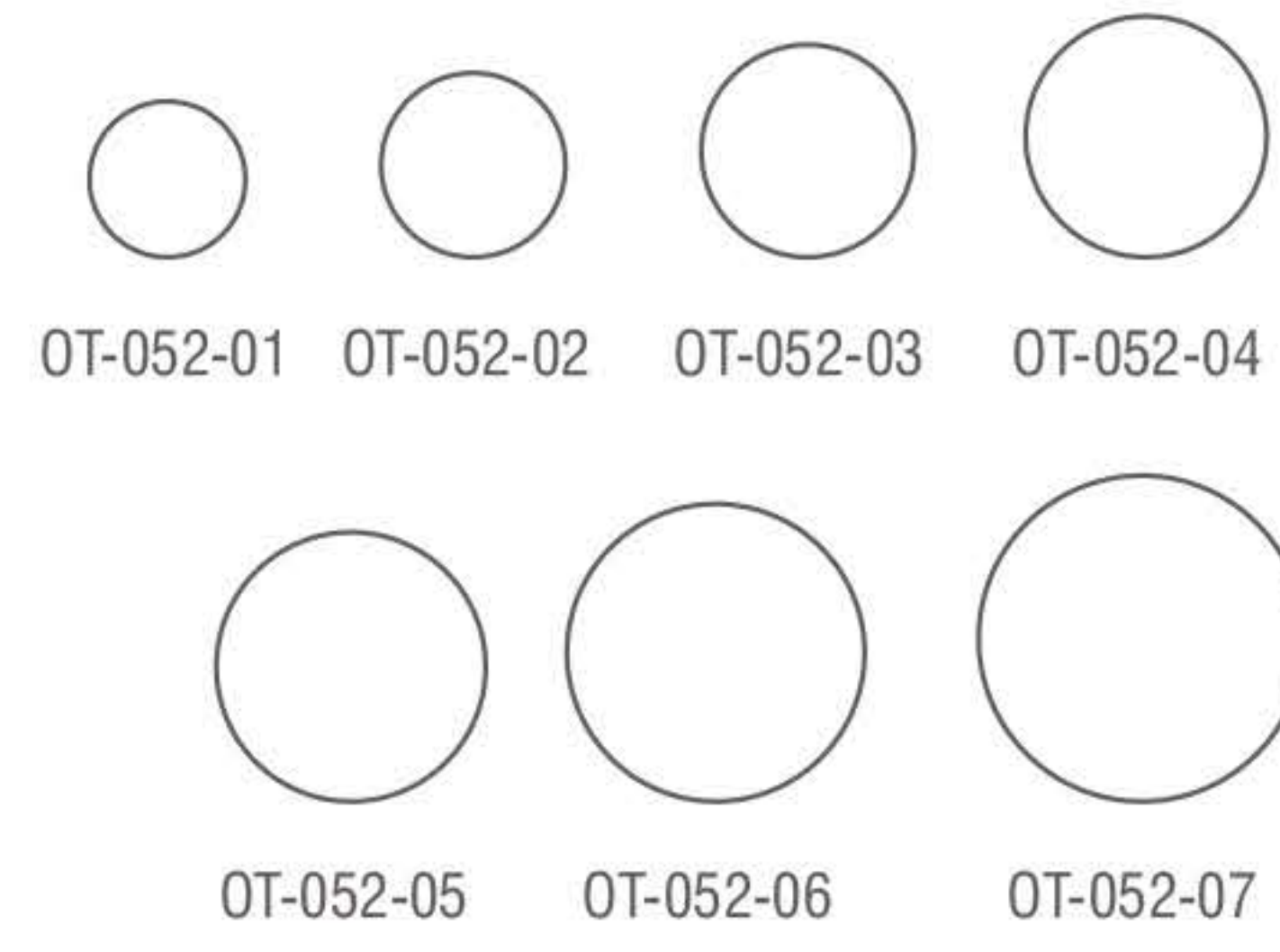

Storage Rack for Ear Specula
 For 12 Specula

Catalog #	Size
OT-060-12	Standard



Richnau-Holmgren Ear Speculum

Catalog #	Diameter
OT-064-02	Ø 2.0 mm
OT-064-04	Ø 3.0 mm
OT-064-06	Ø 4.0 mm



Ear Specula, Tuning Forks
 Ohrspekula, Stimmgabeln
 Espéculos auriculares, Diapasónes
 Spéculums auriculaires, Diapasons
 Specoli auricolari, Diapason

Siegle Otoscope Complete

With 3 Specula Ref: OT-072-01 to OT-072-03

Catalog #	Size
OT-070-00	Standard



Siegle Ear Speculum

Catalog #	Diameter, Profile
OT-072-01	Ø 6.5 mm, Fig. 1
OT-072-02	Ø 7.0 mm, Fig. 2
OT-072-03	Ø 8.0 mm, Fig. 3



Hartmann Tuning Forks

Set of 5 Ref: OT-102-03 to OT-102-05 and OT-104-04 to OT-104-05

Catalog #	Size
OT-100-10	Standard



Hartmann Tuning Forks

Set of 6 Ref:- OT-102-03 to OT-102-06 and OT-104-04 to OT-104-05

Catalog #	Size
OT-100-20	Standard



Hartmann Tuning Forks

Set of 6 Ref:- OT-102-03 to OT-102-06 and OT-104-02 to OT-104-05

Catalog #	Size
OT-100-30	Standard



Tuning Forks
Stimmgabeln
Diapasónes
Diapasons
Diapason

Hartmann Tuning Fork

Catalog #	Frequency
OT-102-01	C 128
OT-102-02	C ¹ 256
OT-102-03	C ¹ 512
OT-102-04	C ² 1024
OT-102-05	C ³ 2048
OT-102-06	C ⁴ 4096



Hartmann Tuning Fork (French)

Catalog #	Frequency
OT-104-01	C ² 16
OT-104-02	C ¹ 32
OT-104-03	C 64
OT-104-04	C 128
OT-104-05	C ¹ 256



Tuning Forks

Set of 5 Ref:- OT-112-02 to OT-112-06

Catalog #	Size
OT-110-00	Standard



Tuning Forks
Stimmgabeln
Diapasónes
Diapasons
Diapason

Tuning Fork

Catalog #	Frequency
OT-112-02	C 128
OT-112-03	C ¹ 256
OT-112-04?	C ² 512
OT-112-05	C ³ 1024
OT-112-06	C ⁴ 2048



Lucae Tuning Fork

Catalog #	Frequency
OT-122-01	C 128
OT-122-02	C ¹ 256
OT-122-03	C ² 512
OT-122-04?	C ³ 1024
OT-122-05	C ⁴ 2048
OT-122-06	C ⁵ 4096



Lucae Tuning Fork
Moveable Up to h

Catalog #	Frequency
OT-126-00	C 128

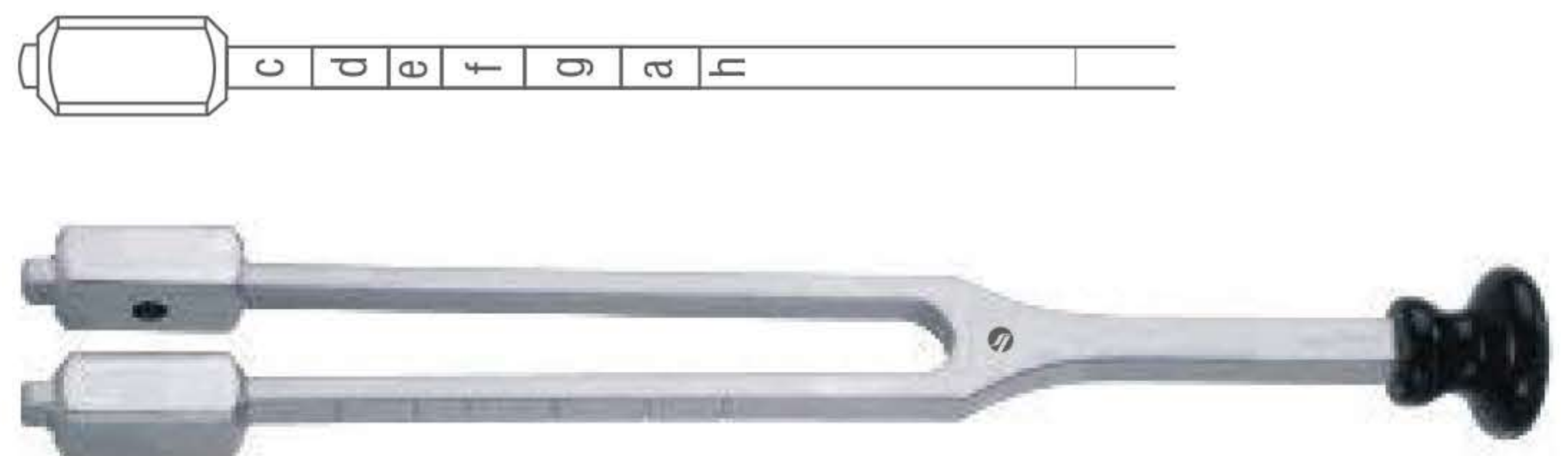

Hartmann Tuning Fork
Moveable up to h

Catalog #	Frequency
OT-128-00	C 128

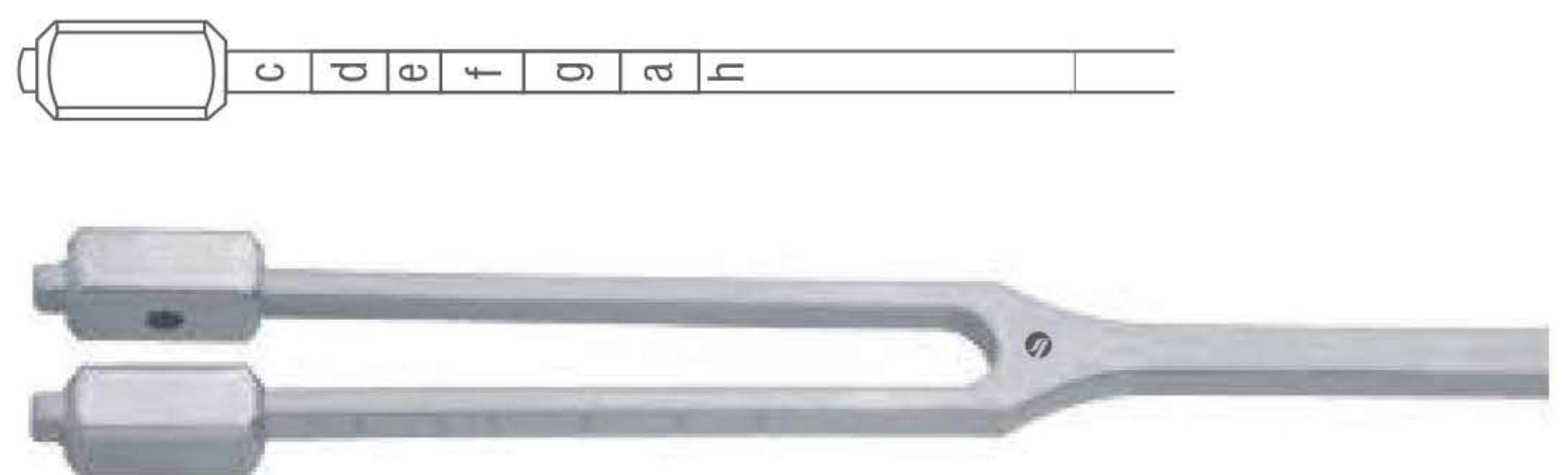

Tuning Forks
 Stimmgabeln
 Diapasónes
 Diapasons
 Diapason

Hartmann Tuning Fork



Catalog #	Frequency
OT-130-00	C' 256

Rydel-Seiffer Tuning Fork
 Also for Neurology



Catalog #	Frequency With Dampers, Frequency Without Dampers
OT-134-00	C 64 , C 128

Neuro Tuning Fork
 With Hammer, Pinwheel, Brush and Needle



Catalog #	Frequency
OT-136-00	Standard

Koenig Tuning Fork
 Moveable Up to g

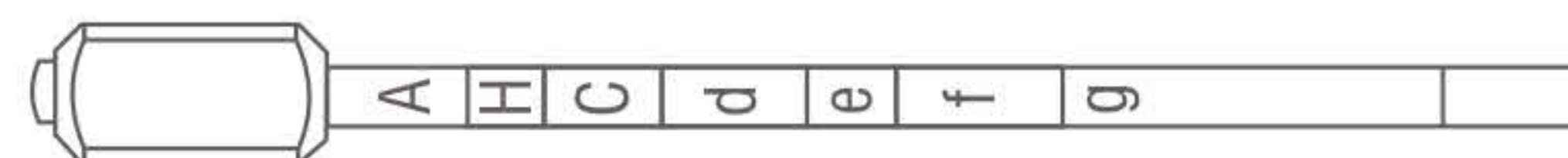

Catalog #	Frequency
OT-138-00	A 109

Tuning Fork



Catalog #	Frequency
OT-140-00	a ¹ 440

Ear Catheters, Polypus Snares
 Ohrkatheter, Polypenschnürer
 Sondas auriculares, Polipótomos
 Sondes auriculaires, Serre-noeuds
 Sonde auricolari, Serranodi

Hartmann Ear Catheter



Catalog #	Size, Profile
OT-150-01	15 cm (6"), Fig. 1
OT-150-02	15 cm (6"), Fig. 2
OT-150-03	15 cm (6"), Fig. 3

Krause Polypus Snare
 Open Tip



Catalog #	Size
OT-161-18	18.5 cm (7 1/4")

Krause-Voss Polypus Snare
 Close Tip



Catalog #	Size
OT-163-18	18.5 cm (7 1/4")

Lange-Wilde Polypus Snare



Catalog #	Size
OT-165-16	16 cm (6 1/4")

Snare Wire



Catalog #	Size, Diameter
OT-170-30	100 cm (39 1/2"), Ø 0.3 mm
OT-170-40	100 cm (39 1/2"), Ø 0.4 mm

Ear Forceps, Ear Polypus Forceps
 Ohrpinzetten, Ohrpolypenzangen
 Pinzas auriculares, Pinzas para pólipos auriculares
 Pincas auriculaires, Pincas pour polypes auriculaires
 Pinze auricolari, Pinze per polipi auricolari

Troeltsch (Wilde) Ear Forcep

Catalog #	Size
OT-201-11	11 cm (4 3/4")
OT-201-13	12.5cm (5")



Troeltsch (Wilde) Ear Forcep

Catalog #	Size
OT-203-11	11 cm (4 3/4")



Troeltsch (Wilde) Ear Forcep
 1 x 2 Teeth

Catalog #	Size
OT-205-11	11 cm (4 3/4")



Adson Ear Forcep
 Bayonet Shaped

Catalog #	Size
OT-207-18	17.5 cm (7")



Gruenwald (Lucae) Ear Forcep
 Bayonet Shaped

Catalog #	Size
OT-211-14	14.5 cm (5 3/4")



Ear Forceps, Ear Polypus Forceps
 Ohrpinzetten, Ohrpolypenzangen
 Pinzas auriculares, Pinzas para pólipos auriculares
 Pincettes auriculaires, Pincettes pour polypes auriculaires
 Pinze auricolari, Pinze per polipi auricolari

Jansen Ear Forcep
 Bayonet Shaped

Catalog #	Size
OT-213-16	16 cm (6 ¼")
OT-213-21	21.5 cm (8 ½")



Gruenwald (Lucae) Ear Forcep
 1 x 2 Teeth, Bayonet Shaped

Catalog #	Size
OT-215-14	14.5 cm (5 ¾")

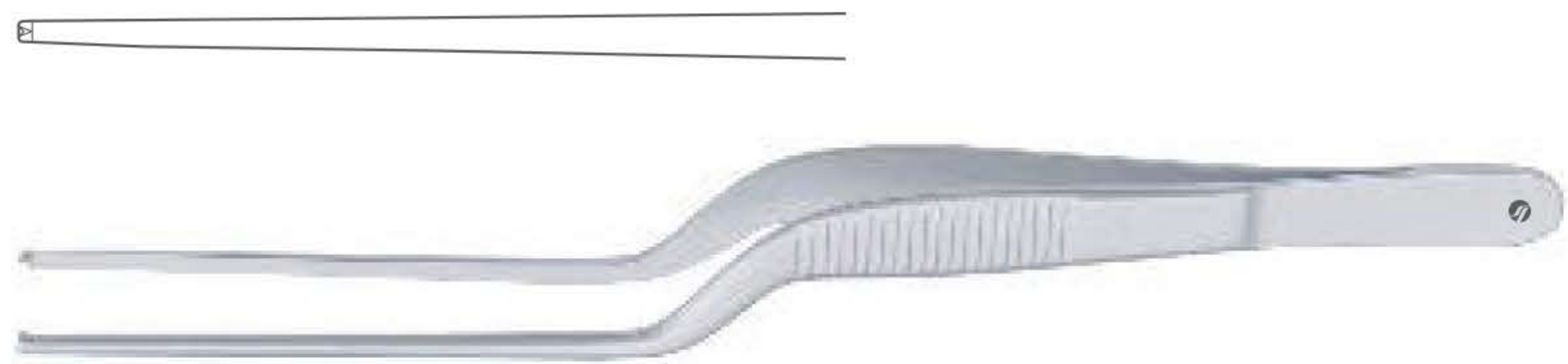

Littauer Ear Polypus Forcep

Catalog #	Size
OT-221-10	10 cm (4")



Hartmann Ear Polypus Forcep
 Fine Model

Catalog #	Size
OT-223-12	12 cm (4 ¾")



Hartmann Ear Polypus Forcep
 Regular Model

Catalog #	Size
OT-225-14	14 cm (5 ½")



Ear Forceps, Ear Polypus Forceps
 Ohrpinzetten, Ohrpolypenzangen
 Pinzas auriculares, Pinzas para pólipos auriculares
 Pincès auriculaires, Pincès pour polypes auriculaires
 Pinze auricolari, Pinze per polipi auricolari

Tilley Ear Polypus Forcep

Catalog #	Size
OT-229-14	14 cm (5 1/2")
OT-229-16	16 cm (6 1/4")



Buck Foreign Body Forcep

Catalog #	Size
OT-235-11	11.5 cm (4 1/2")



Quire Foreign Body Forcep

Catalog #	Size
OT-237-10	10.5 cm (4")



Hartmann-Wullstein Alligator Forcep

Catalog #	Size
OT-251-08	8.5 cm (3 1/4")



**Hartmann-Wullstein Alligator Forcep
 Cup Shaped**

Catalog #	Size, Diameter
OT-253-08	8.5 cm (3 1/4"), Ø 1.0 mm



Ear Forceps, Ear Polypus Forceps
 Ohrpinzetten, Ohrpolypenzangen
 Pinzas auriculares, Pinzas para pólipos auriculares
 Pincès auriculaires, Pincès pour polypes auriculaires
 Pinze auricolari, Pinze per polipi auricolari

Hartmann Alligator Forcep

Catalog #	Size
OT-255-08	8.5 cm (3 1/4")
OT-255-14	14 cm (5 1/2")
OT-255-16	16 cm (6 1/4")



Hartmann Alligator Forcep 1 x 2 Teeth

Catalog #	Size
OT-257-08	8.5 cm (3 1/4")
OT-257-14	14 cm (5 1/2")



Hartmann Alligator Forcep Cup Shaped

Catalog #	Size, Diameter
OT-261-20	8.5 cm (3 1/4"), Ø 2.0 mm
OT-261-25	8.5 cm (3 1/4"), Ø 2.5 mm
OT-261-30	8.5 cm (3 1/4"), Ø 3.0 mm



Hartmann Alligator Forcep Bent Upwards, Cup Shaped

Catalog #	Size, Diameter
OT-263-20	8.5 cm (3 1/4"), Ø 2.0 mm
OT-263-30	8.5 cm (3 1/4"), Ø 3.0 mm



Ear Forceps, Ear Polypus Forceps, Micro Ear Forceps
 Ohrpinzetten, Ohrpolypenzangen, Mikro-Ohrzängchen
 Pinzas auriculares, Pinzas para pólipos auriculares, Micro pinzas auriculares
 Pincettes auriculaires, Pincettes pour polypes auriculaires, Micro Pincettes auriculaires
 Pinze auricolari, Pinze per polipi auricolari, Micro Pinze auricolari

Struempel Alligator Forcep

Catalog #	Size
OT-265-08	8.5 cm (3 1/4")



Hartmann-Weingartner Alligator Forcep

Catalog #	Size
OT-267-08	8.5 cm (3 1/4")



Hartmann-Hoffmar Alligator Punch Forcep

Catalog #	Size
OT-271-08	8.5 cm (3 1/4")



McGee Micro Alligator Forcep
 Smooth, Straight

Catalog #	Size, Jaw Size
OT-281-08	8 cm (3"), 4.0 x 0.8 mm



McGee Micro Alligator Forcep
 Serrated, Straight

Catalog #	Size, Jaw Size
OT-283-08	8 cm (3"), 4.0 x 0.8 mm



Micro Ear Forceps
 Mikro-Ohrzängchen
 Micro pinzas auriculares
 Micro Pince auriculaires
 Micro Pinze auricolari

McGee Micro Alligator Forcep
 Serrated, Bent Upwards

Catalog #	Size, Jaw Size
OT-285-08	8 cm (3"), 4.0 x 0.8 mm



McGee Micro Alligator Forcep
 Serrated, Right

Catalog #	Size, Jaw Size
OT-287-08	8 cm (3"), 4.0 x 0.8 mm



McGee Micro Alligator Forcep
 Serrated, Left

Catalog #	Size, Jaw Size
OT-289-08	8 cm (3"), 4.0 x 0.8 mm



Mini-McGee Micro Alligator Forcep
 Smooth, Straight

Catalog #	Size, Jaw Size
OT-291-08	8 cm (3"), 3.5 x 0.6 mm



Mini-McGee Micro Alligator Forcep
 Serrated, Straight

Catalog #	Size, Jaw Size
OT-293-08	8 cm (3"), 3.5 x 0.6 mm



Micro Ear Forceps
 Mikro-Ohrzängchen
 Micro pinzas auriculares
 Micro Pince auriculaires
 Micro Pinze auricolari

Micro Alligator Forcep
 Smooth, Straight

Catalog #	Size, Jaw Size
OT-301-08	8 cm (3"), 4.0 x 0.6 mm



Micro Alligator Forcep
 Serrated, Straight

Catalog #	Size, Jaw Size
OT-303-08	8 cm (3"), 4.0 x 0.6 mm



Micro Alligator Forcep
 Serrated, Bent Upwards

Catalog #	Size, Jaw Size
OT-305-08	8 cm (3"), 4.0 x 0.6 mm



Micro Alligator Forcep
 Serrated, Right

Catalog #	Size, Jaw Size
OT-307-08	8 cm (3"), 4.0 x 0.6 mm



Micro Alligator Forcep
 Serrated, Left

Catalog #	Size, Jaw Size
OT-309-08	8 cm (3"), 4.0 x 0.6 mm



Micro Ear Forceps
 Mikro-Ohrzängchen
 Micro pinzas auriculares
 Micro Pince auriculaires
 Micro Pinze auricolari

Micro Alligator Forcep
 Straights, Cup Shaped

Catalog #	Size, Cup Size, Jaw Size
OT-311-08	8 cm (3"), 1.0 x 0.9 mm, 4.0 mm



Micro Alligator Forcep
 Bent Upwards, Cup Shaped

Catalog #	Size, Cup Size, Jaw Size
OT-313-08	8 cm (3"), 1.0 x 0.9 mm, 4.0 mm



Micro Alligator Forcep
 Right, Cup Shaped

Catalog #	Size, Cup Size, Jaw Size
OT-315-08	8 cm (3"), 1.0 x 0.9 mm, 4.0 mm



Micro Alligator Forcep
 Left, Cup Shaped

Catalog #	Size, Cup Size, Jaw Size
OT-317-08	8 cm (3"), 1.0 x 0.9 mm, 4.0 mm



Micro Alligator Forcep
 Straight, Cup Shaped

Catalog #	Size, Cup Size, Jaw Size
OT-321-08	8 cm (3"), 0.6 x 0.5 mm, 3.5 mm



Micro Ear Forceps
 Mikro-Ohrzängchen
 Micro pinzas auriculares
 Micro Pince auriculaires
 Micro Pinze auricolari

Micro Alligator Forcep
 Bent Upwards, Cup Shaped

Catalog #	Size, Cup Size, Jaw Size
OT-323-08	8 cm (3"), 0.6 x 0.5 mm, 3.5 mm



Micro Alligator Forcep
 Right, Cup Shaped

Catalog #	Size, Cup Size, Jaw Size
OT-325-08	8 cm (3"), 0.6 x 0.5 mm, 3.5 mm



Micro Alligator Forcep
 Left, Cup Shaped

Catalog #	Size, Cup Size, Jaw Size
OT-327-08	8 cm (3"), 0.6 x 0.5 mm, 3.5 mm



Bellucci Micro Scissor
 Straight, Very Fine

Catalog #	Size, Blade Size
OT-331-08	8 cm (3"), 4.0 x 0.8 mm

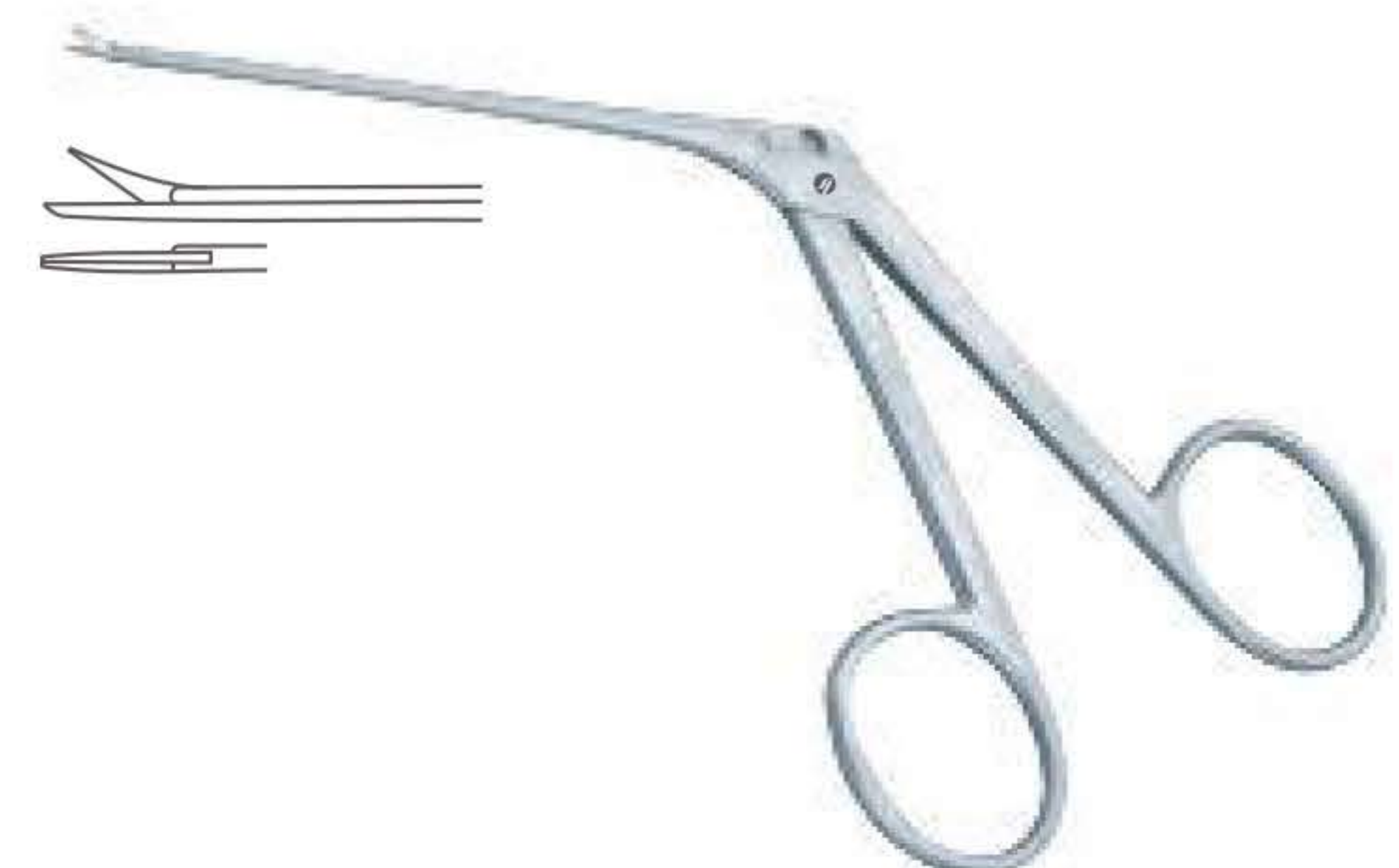

Bellucci Micro Scissor
 Bent Upwards, Very Fine

Catalog #	Size, Blade Size
OT-333-08	8 cm (3"), 4.0 x 0.8 mm



Micro Ear Scissors
 Mikro-Ohrscherchen
 Micro tijeras auriculares
 Micro Ciseaux auriculaires
 Micro Forbici auricolari

Bellucci Micro Scissor
 Right, Very Fine

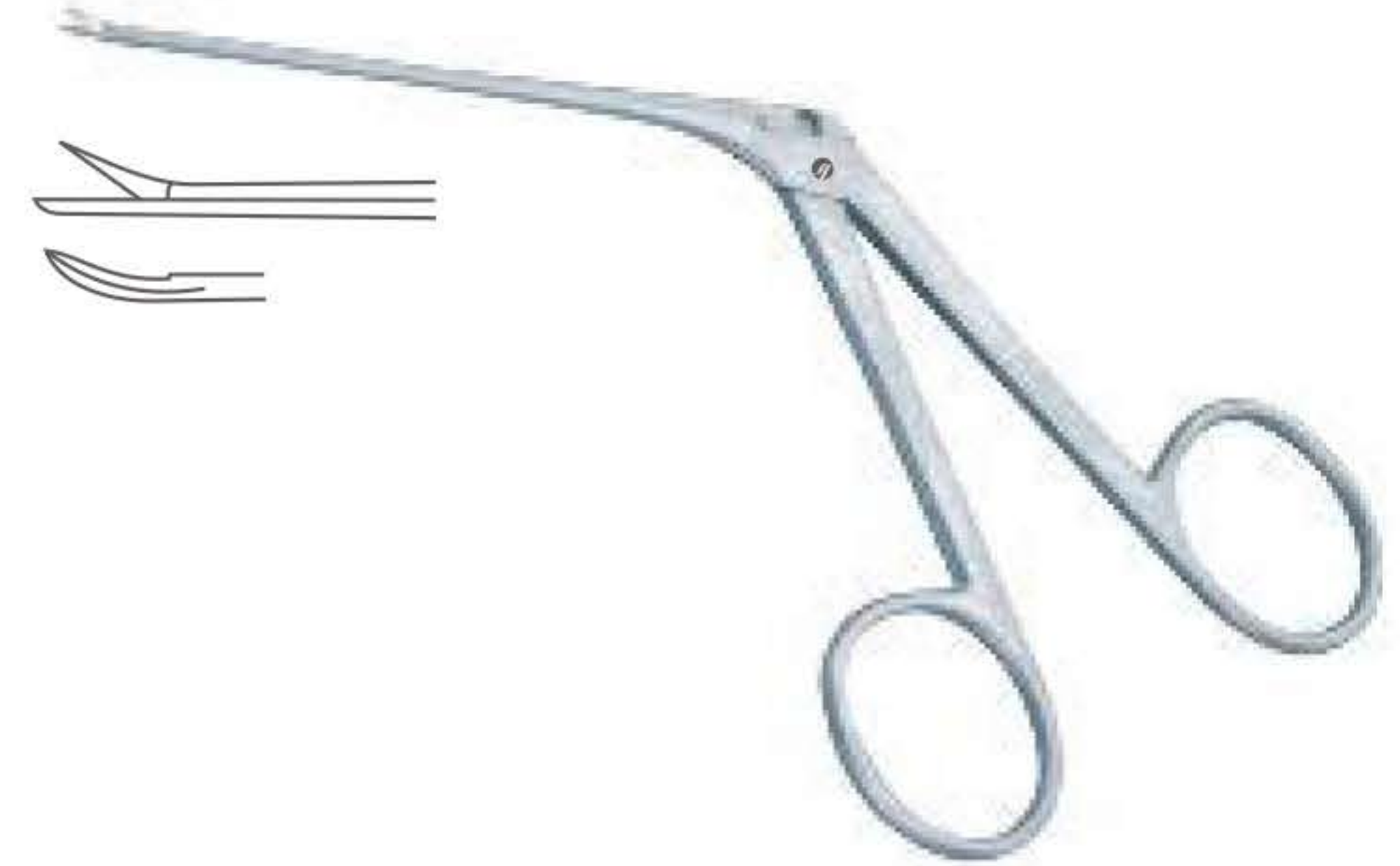

Catalog #	Size, Blade Size
OT-335-08	8 cm (3"), 4.0 x 0.8 mm

Bellucci Micro Scissor
 Left, Very Fine



Catalog #	Size, Blade Size
OT-337-08	8 cm (3"), 4.0 x 0.8 mm

Wullstein Micro Scissor
 Straight



Catalog #	Size, Blade Size
OT-341-08	8 cm (3"), 4.0 x 1.8 mm

Wullstein Micro Scissor
 Bent Upwards



Catalog #	Size, Blade Size
OT-343-08	8 cm (3"), 4.0 x 1.8 mm

Wullstein Micro Scissor
 Right



Catalog #	Size, Blade Size
OT-345-08	8 cm (3"), 4.0 x 1.8 mm

Micro Ear Scissors
 Mikro-Ohrscherchen
 Micro tijeras auriculares
 Micro Ciseaux auriculaires
 Micro Forbici auricolari

Wullstein Micro Scissor
 Left



Catalog #	Size, Blade Size
OT-347-08	8 cm (3"), 4.0 x 1.8 mm

Shea Micro Scissor
 Straight



Catalog #	Size, Blade Size
OT-351-08	8 cm (3"), 7.0 x 1.8 mm

Shea Micro Scissor
 Right



Catalog #	Size, Blade Size
OT-355-08	8 cm (3"), 7.0 x 1.8 mm

Shea Micro Scissor
 Left



Catalog #	Size, Blade Size
OT-357-08	8 cm (3"), 7.0 x 1.8 mm

McGee Wire Bending Forcep
 Bent Downwards



Catalog #	Size, Jaw Size
OT-361-01	8 cm (3"), 3.5 x 0.8 mm
OT-361-02	8 cm (3"), 3.5 x 0.8 mm

Micro Ear Forceps, Micro Ear Knives
 Mikro-Ohrzängchen, Mikro-Ohrmesser
 Micro pinzas auriculares, Micro cuchillos auriculares
 Micro Pince auriculaires, Micro Couteaux auriculaires
 Micro Pinze auricolari, Micro Coltelli

House-Dieter Malleus Nipper



Catalog #	Size, Jaw Opening, Profile
OT-365-01	8 cm (3"), 1.3 mm, Up Cutting
OT-365-02	8 cm (3"), 1.3 mm, Down Cutting

House-Dieter Malleus Nipper



Catalog #	Size, Jaw Opening, Profile
OT-365-03	8 cm (3"), 1.3 mm, Right Cutting
OT-365-04	8 cm (3"), 1.3 mm, Left Cutting

Fuller Introducing Forcep For Teflon Prosthesis



Catalog #	Size
OT-367-08	8 cm (3")

Schuknecht Rotary Knife



Catalog #	Size
OT-401-01	15 cm (6")
OT-401-02	15 cm (6")

Schuknecht Sickle Knife



Catalog #	Size
OT-403-15	14.5 cm (5 3/4")

Micro Ear Knives
 Mikro-Ohrmesser
 Micro cuchillos auriculares
 Micro Couteaux auriculaires
 Micro Coltelli

Wullstein Sickle Knife



Catalog #	Size
OT-405-15	15.5 cm (6")

Tabb Mucosa Knife



Catalog #	Size
OT-407-15	15.5 cm (6")

Plester Flap Knife



Catalog #	Size
OT-409-15	15 cm (6")

Plester Sickle Knife



Catalog #	Size
OT-415-15	15 cm (6")

Sexton Myringotomy Knife



Catalog #	Size
OT-417-15	15 cm (6")

Micro Ear Knives, Micro Ear Hooks
 Mikro-Ohrmesser, Mikro-Ohrhäkchen
 Micro cuchillos auriculares, Micro ganchitos auriculares
 Micro Couteaux auriculaires, Micro Crochets auriculaires
 Micro Coltelli, Micro Uncini auricolari

Rosen Circular Cut Knife



Catalog #	Size, Diameter, Profile
OT-421-01	15 cm (6"), Ø 3.0 mm, Fig. 1
OT-421-02	15 cm (6"), Ø 2.8 mm, Fig. 2
OT-421-03	15 cm (6"), Ø 2.6 mm, Fig. 3
OT-421-04	15 cm (6"), Ø 2.0 mm, Fig. 4
OT-421-05	15 cm (6"), Ø 1.6 mm, Fig. 5
OT-421-06	15 cm (6"), Ø 1.4 mm, Fig. 6
OT-421-07	15 cm (6"), Ø 1.0 mm, Fig. 7

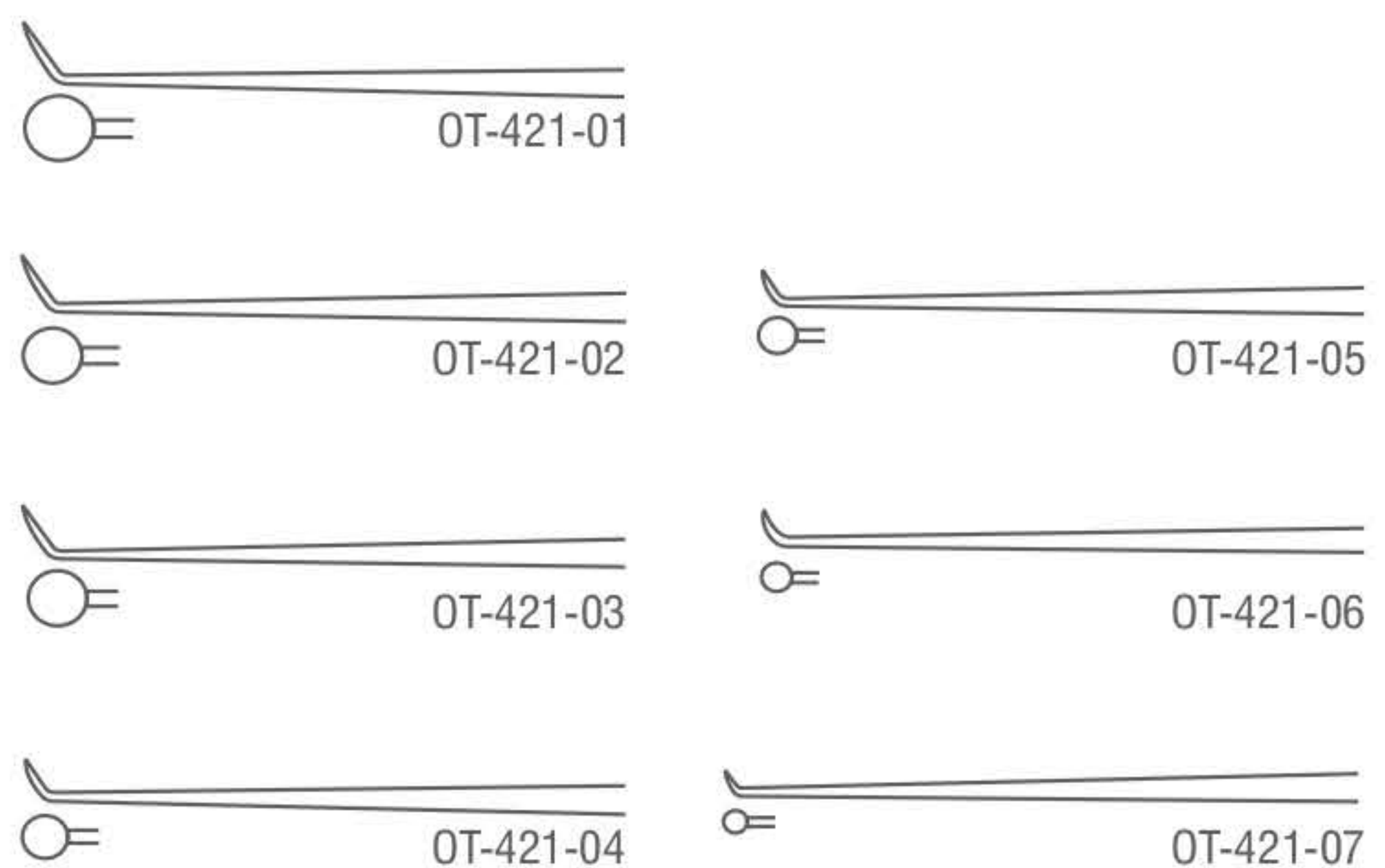

Barbara Micro Ear Pick



Catalog #	Size
OT-450-16	16 cm (6 1/4")

Barbara Micro Ear Pick Angled



Catalog #	Size
OT-451-16	16 cm (6 1/4")

Barbara Micro Ear Pick



Catalog #	Size
OT-453-16	16 cm (6 1/4")

Rosen Micro Ear Pick



Catalog #	Size
OT-455-16	16 cm (6 1/4")

Micro Ear Hooks, Micro Ear Needles
 Mikro-Ohrhäkchen, Mikro-Ohrnadeln
 Micro ganchitos auriculares, Micro agujas auriculares
 Micro Crochets auriculaires, Micro Aiguilles auriculaires
 Micro Uncini auricolari, Micro Aghi auricolari

Barbara Micro Ear Pick
 Angled 25°



Catalog #	Size, Tip Size
OT-459-03	16 cm (6 1/4"), 0.3 mm
OT-459-06	16 cm (6 1/4"), 0.6 mm
OT-459-10	16 cm (6 1/4"), 1.0 mm

Barbara Micro Ear Pick
 Angled 45°



Catalog #	Size, Tip Size
OT-461-03	16 cm (6 1/4"), 0.3 mm
OT-461-06	16 cm (6 1/4"), 0.6 mm
OT-461-10	16 cm (6 1/4"), 1.0 mm
OT-461-12	16 cm (6 1/4"), 1.2 mm
OT-461-15	16 cm (6 1/4"), 1.5 mm
OT-461-20	16 cm (6 1/4"), 2.0 mm
OT-461-25	16 cm (6 1/4"), 2.5 mm

Barbara Micro Ear Pick
 Angled 90°



Catalog #	Size, Tip Size
OT-463-03	16 cm (6 1/4"), 0.3 mm
OT-463-06	16 cm (6 1/4"), 0.6 mm
OT-463-10	16 cm (6 1/4"), 1.0 mm
OT-463-12	16 cm (6 1/4"), 1.2 mm
OT-463-15	16 cm (6 1/4"), 1.5 mm
OT-463-20	16 cm (6 1/4"), 2.0 mm
OT-463-25	16 cm (6 1/4"), 2.5 mm

Micro Ear Hooks, Micro Ear Needles
 Mikro-Ohrhäkchen, Mikro-Ohrnadeln
 Micro ganchitos auriculares, Micro agujas auriculares
 Micro Crochets auriculaires, Micro Aiguilles auriculaires
 Micro Uncini auricolari, Micro Aghi auricolari

Barbara Micro Ear Needle
 Curved Down



Catalog #	Size, Tip Size
OT-465-05	16 cm (6 1/4"), 0.5 mm
OT-465-10	16 cm (6 1/4"), 1.0 mm

Micro Ear Needle
 Angled 90°



Catalog #	Size, Tip Size
OT-467-03	15.5 cm (6"), 0.3 mm
OT-467-06	15.5 cm (6"), 0.6 mm
OT-467-10	15.5 cm (6"), 1.0 mm

Micro Ear Needle
 Angled 90°



Catalog #	Size, Tip Size
OT-469-03	15.5 cm (6"), 0.3 mm
OT-469-06	15.5 cm (6"), 0.6 mm
OT-469-10	15.5 cm (6"), 1.0 mm

McGee Micro Ear Needle
 For Footplate



Catalog #	Size, Tip Size
OT-473-05	15.5 cm (6"), 0.5 mm
OT-473-10	15.5 cm (6"), 1.0 mm

Micro Ear Hooks, Micro Ear Needles
 Mikro-Ohrhäkchen, Mikro-Ohrnadeln
 Micro ganchitos auriculares, Micro agujas auriculares
 Micro Crochets auriculaires, Micro Aiguilles auriculaires
 Micro Uncini auricolari, Micro Aghi auricolari

McGee Micro Ear Needle
 For Footplate

Catalog #	Size, Tip Size
OT-475-05	15.5 cm (6"), 0.5 mm
OT-475-10	15.5 cm (6"), 1.0 mm



Barbara Micro Ear Needle

Catalog #	Size
OT-478-16	15.5 cm (6")



Barbara Micro Ear Pick

Catalog #	Size
OT-479-16	15.5 cm (6")



Micro Ear Pick
 Angled 25°

Catalog #	Size, Tip Size
OT-481-03	15.5 cm (6"), 0.3 mm
OT-481-06	15.5 cm (6"), 0.6 mm
OT-481-10	15.5 cm (6"), 1.0 mm



Micro Ear Pick
 Angled 25°

Catalog #	Size, Tip Size
OT-483-03	15.5 cm (6"), 0.3 mm
OT-483-06	15.5 cm (6"), 0.6 mm
OT-483-10	15.5 cm (6"), 1.0 mm



Micro Ear Hooks, Micro Ear Needles
 Mikro-Ohrhäkchen, Mikro-Ohrnadeln
 Micro ganchitos auriculares, Micro agujas auriculares
 Micro Crochets auriculaires, Micro Aiguilles auriculaires
 Micro Uncini auricolari, Micro Aghi auricolari

Micro Ear Pick
 Angled 45°

Catalog #	Size, Tip Size
OT-485-03	15.5 cm (6"), 0.3 mm
OT-485-06	15.5 cm (6"), 0.6 mm
OT-485-10	15.5 cm (6"), 1.0 mm



Micro Ear Pick
 Angled 45°

Catalog #	Size, Tip Size
OT-487-03	15.5 cm (6"), 0.3 mm
OT-487-06	15.5 cm (6"), 0.6 mm
OT-487-10	15.5 cm (6"), 1.0 mm



Micro Ear Needle
 Angled 25°

Catalog #	Size, Tip Size
OT-491-03	15.5 cm (6"), 0.3 mm
OT-491-06	15.5 cm (6"), 0.6 mm



Shambaugh Micro Ear Needle
 Angled 25°

Catalog #	Size, Tip Size
OT-491-10	15.5 cm (6"), 1.0 mm



Micro Ear Hooks, Micro Dissectors
 Mikro-Ohrhäkchen, Mikro-Dissektoren
 Micro ganchitos auriculares, Micro disecadores
 Micro Crochets auriculaires, Micro Dissecteurs
 Micro Uncini auricolari, Micro Dissettori

Micro Ear Needle
 Angled 45°



Catalog #	Size, Tip Size
OT-493-03	15.5 cm (6"), 0.3 mm
OT-493-06	15.5 cm (6"), 0.6 mm



Shambaugh Micro Ear Needle
 Angled 45°

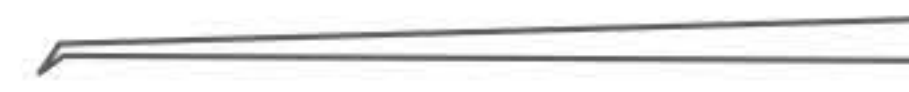

Catalog #	Size, Tip Size
OT-493-10	15.5 cm (6"), 1.0 mm

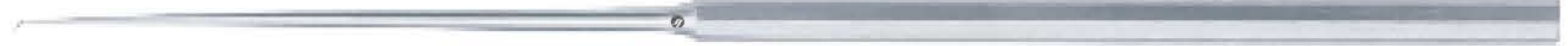

Shea Exploring Hook
 Angled 45°, Blunt



Catalog #	Size, Tip Size
OT-497-20	15.5 cm (6"), 2.0 mm



Austin Attic Dissector
 Angled 90°, Blunt



Catalog #	Size, Tip Size
OT-501-30	15.5 cm (6"), 3.0 mm



Fisch Micro Dissector



Catalog #	Size, Profile
OT-505-01	15.5 cm (6"), Angled to Right
OT-505-02	15.5 cm (6"), Angled to Left
OT-505-03	15.5 cm (6"), Angled to Right
OT-505-04	15.5 cm (6"), Angled to Left

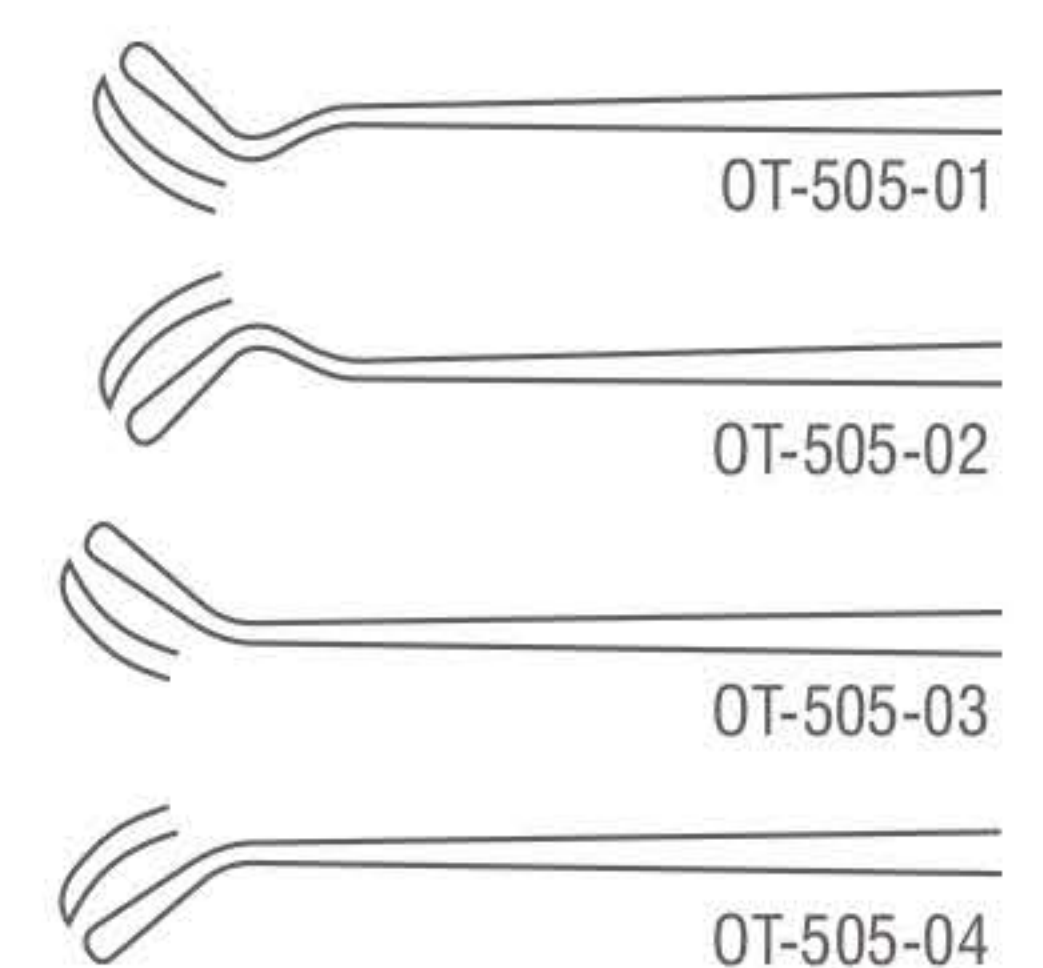

Micro Curettes, Micro Dissectors, Micro Measuring Rods
 Mikro-Küretten, Mikro-Dissektoren, Mikro-Messsonden
 Micro cucharillas, Micro disecadores, Micro Sondas para medir
 Micro Curettes, Micro Dissecteurs, Micro Sondes pour mesurer
 Micro cucchiari, Micro Dissettori, Micro Sonde per misurare

Rosen Micro Ear Periosteal Elevator



Catalog #	Size
OT-509-01	15.5 cm (6")
OT-509-02	15.5 cm (6")
OT-509-03	15.5 cm (6")

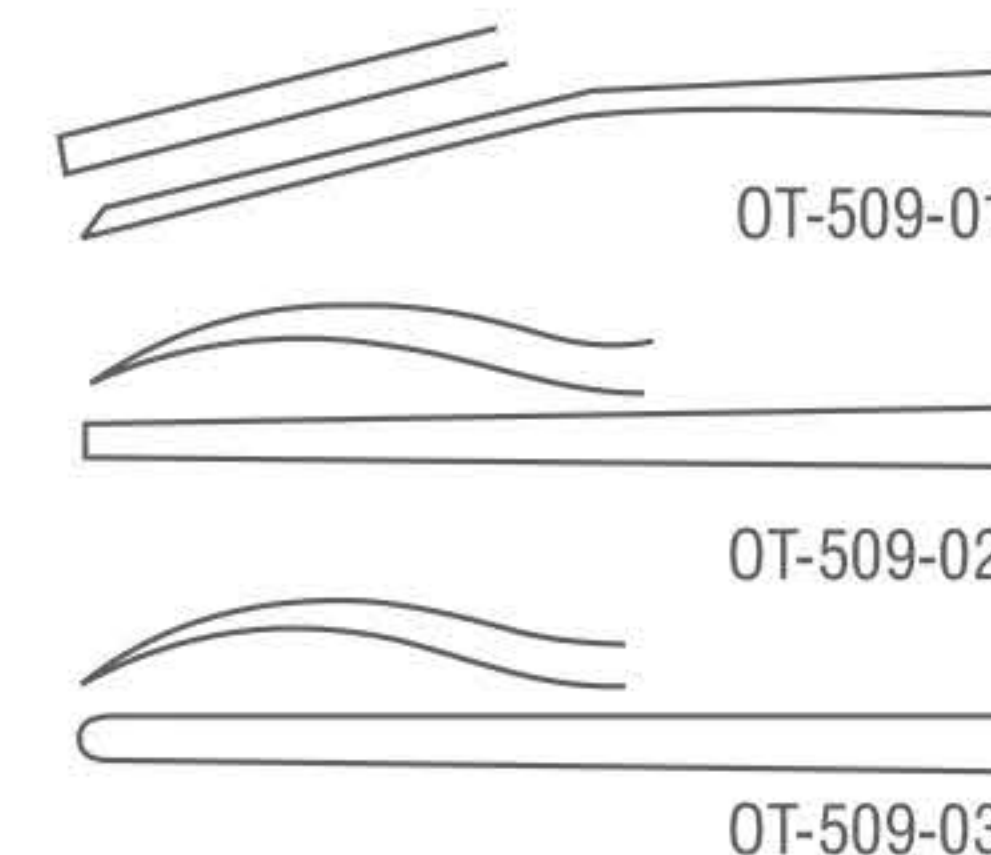

Rosen Micro Curette

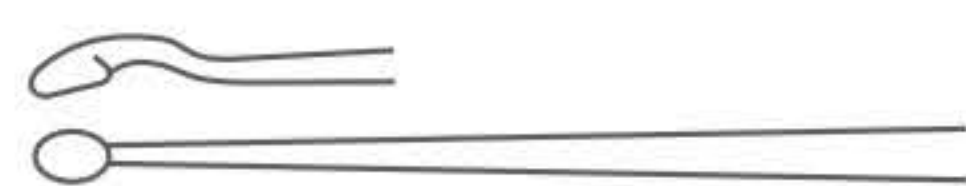

Catalog #	Size
OT-509-04	15.5 cm (6")

Rosen Micro Dissector



Catalog #	Size
OT-509-05	15.5 cm (6")
OT-509-06	15.5 cm (6")

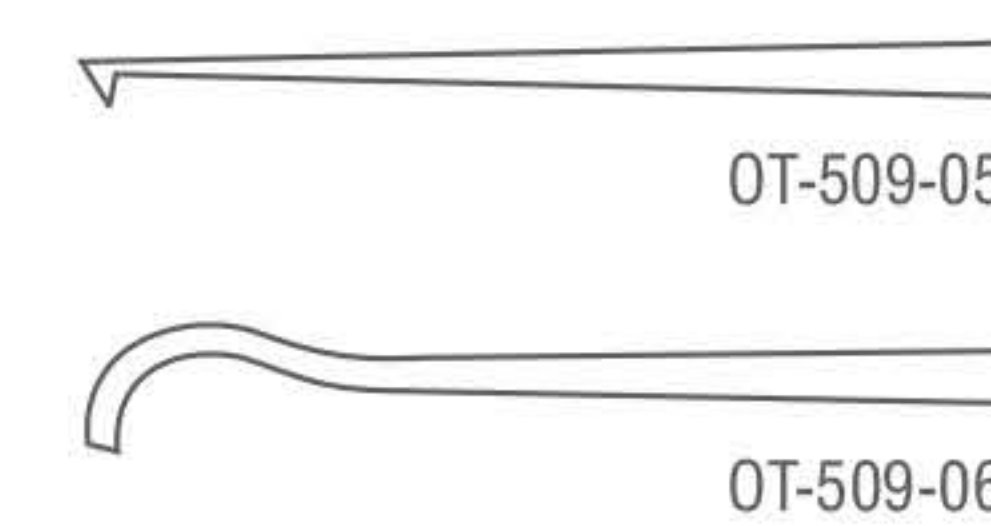

House Micro Measuring Rod



Catalog #	Size, Tip Size
OT-511-01	15.5 cm (6"), 3.5 mm
OT-511-02	15.5 cm (6"), 4.0 mm
OT-511-03	15.5 cm (6"), 4.5 mm
OT-511-04	15.5 cm (6"), 5.0 mm

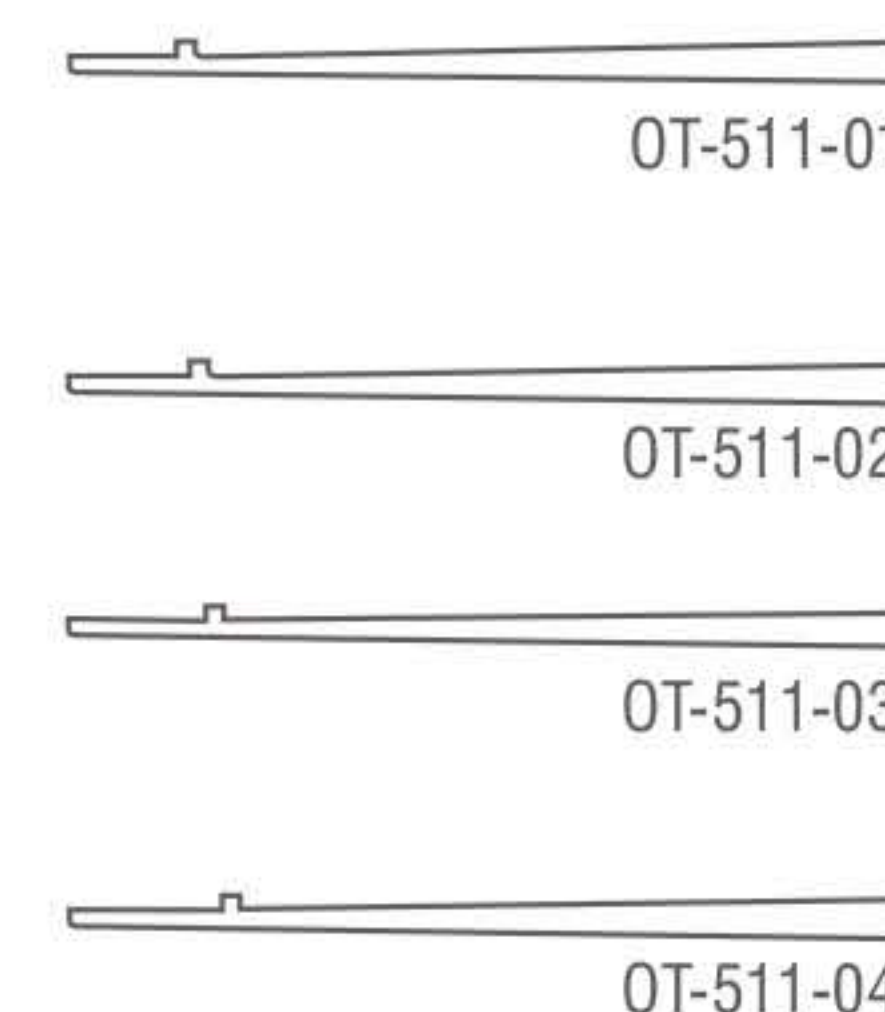

Micro Curettes
 Mikro-Küretten
 Micro cucharillas
 Micro Curettes
 Micro cucchiai

Buckingham Chisel



Catalog #	Size, Tip Size
OT-515-01	18 cm (7"), 0.5 mm
OT-515-02	18 cm (7"), 1.0 mm
OT-515-04	18 cm (7"), 1.5 mm

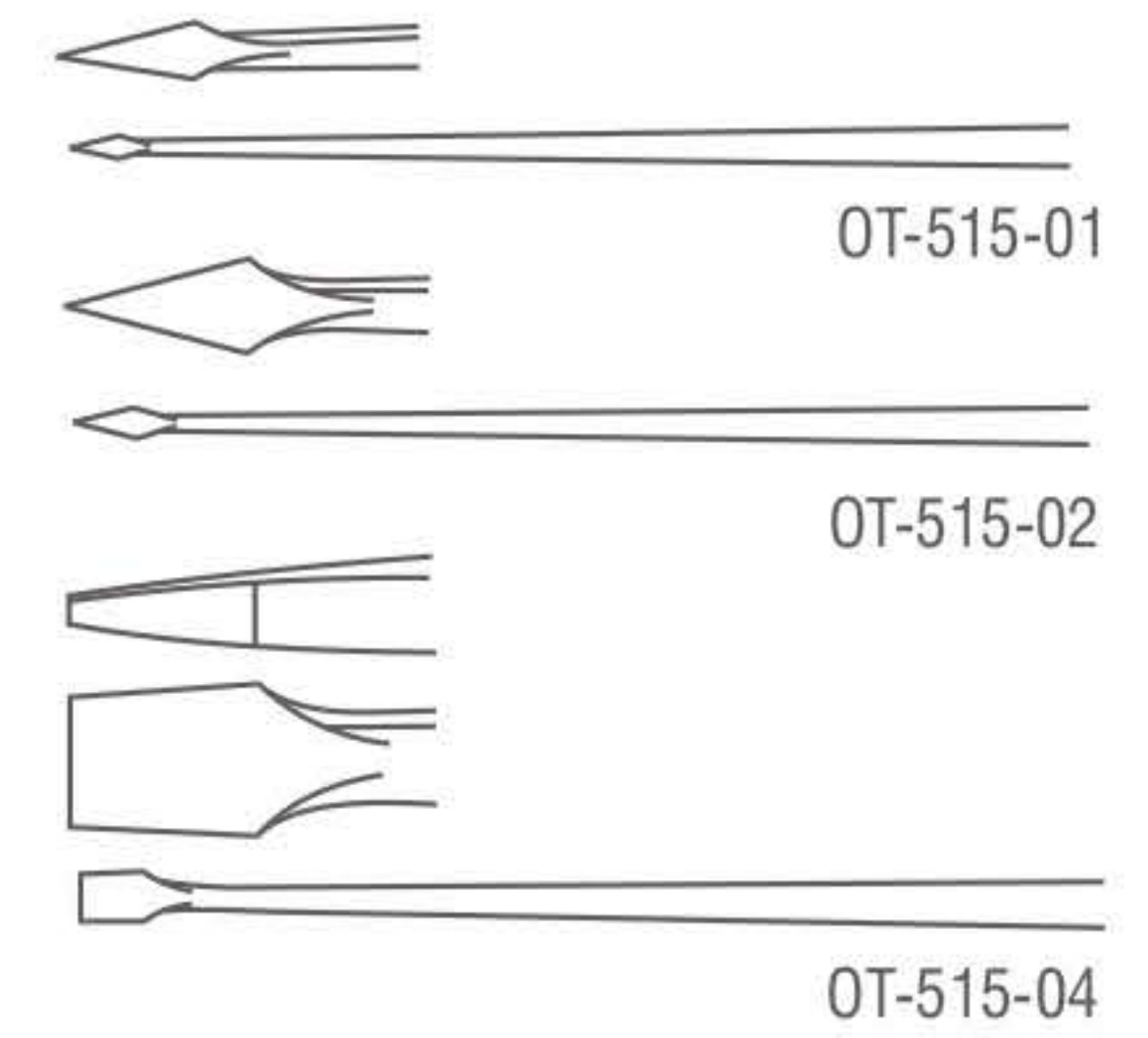

Dingmann Otobradler

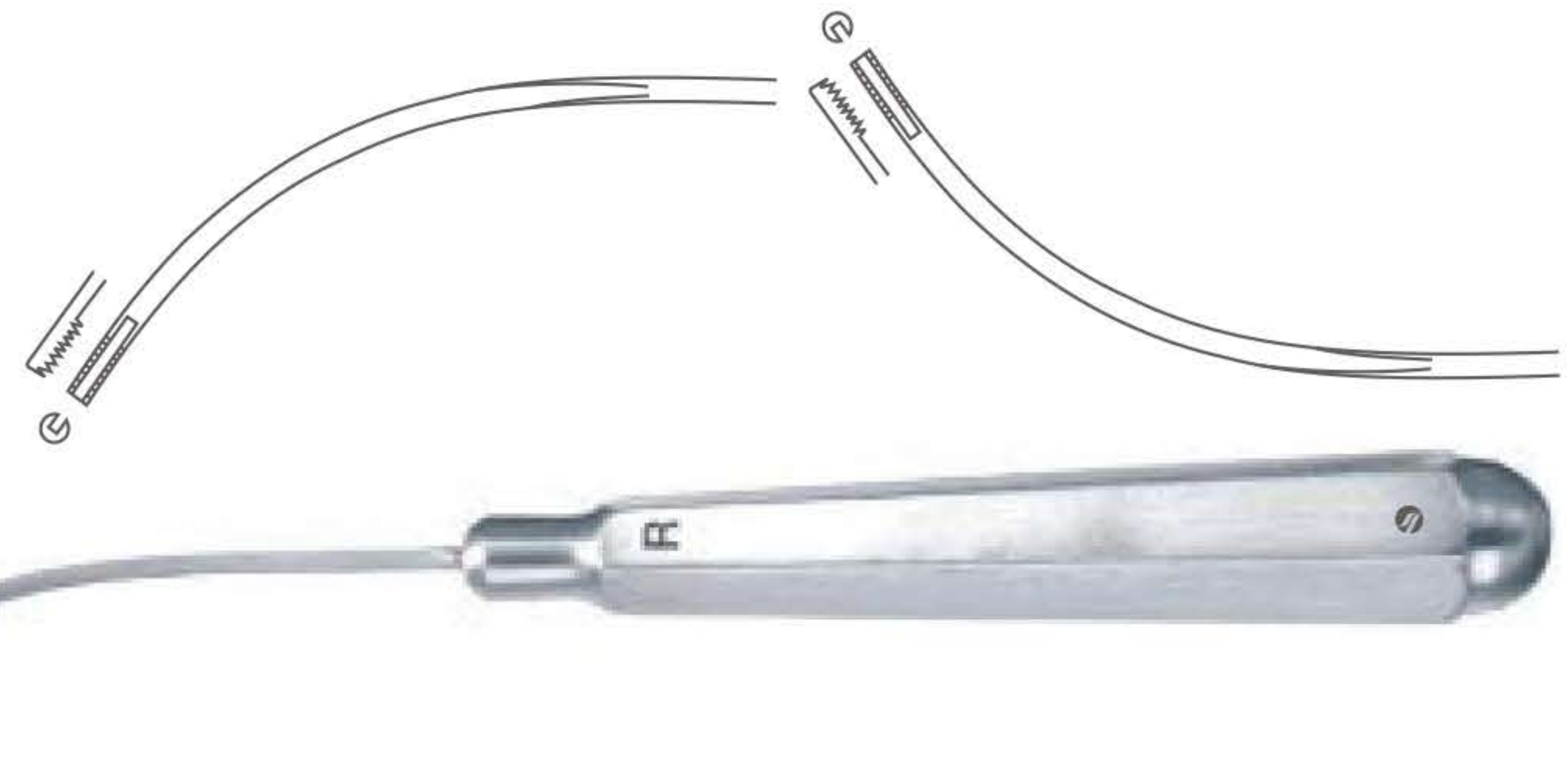

Catalog #	Profile
OT-517-01	Left
OT-517-02	Right

House Micro Ear Curette



Catalog #	Size, Cup Size 1, Cup Size 2
OT-520-01	14.5 cm (5 3/4"), 1.0 mm, 1.2 mm
OT-520-02	14.5 cm (5 3/4"), 1.5 mm, 1.8 mm
OT-520-03	14.5 cm (5 3/4"), 1.0 mm, 1.2 mm
OT-520-04	14.5 cm (5 3/4"), 1.5 mm, 1.8 mm

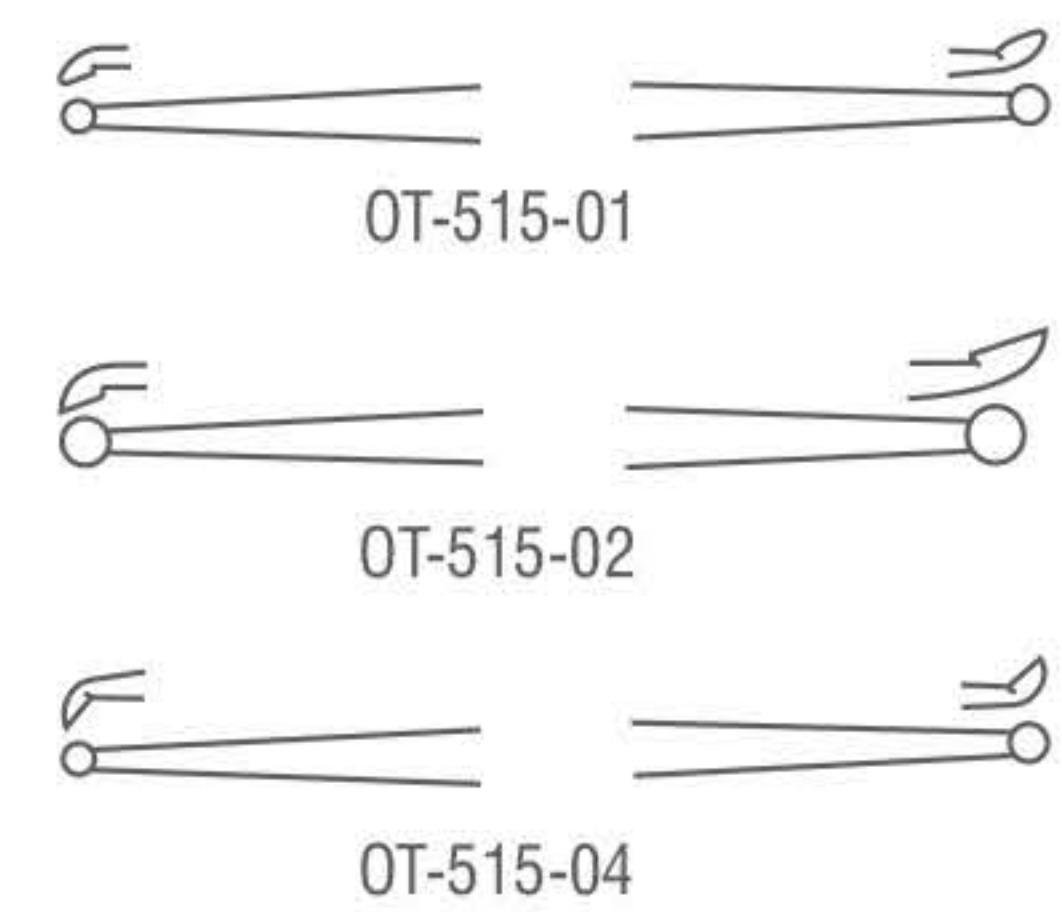

Shea Micro Ear Curette



Catalog #	Size
OT-525-14	14.5 cm (5 3/4")

Micro Dissectors
 Mikro-Dissektoren
 Micro disecadores
 Micro Dissecteurs
 Micro Dissettori

Zoellner Micro Ear Needle
 Straight



Catalog #	Size
OT-535-01	13.5 cm (5 1/2")

Zoellner Micro Ear Needle
 Angled 45° Upwards

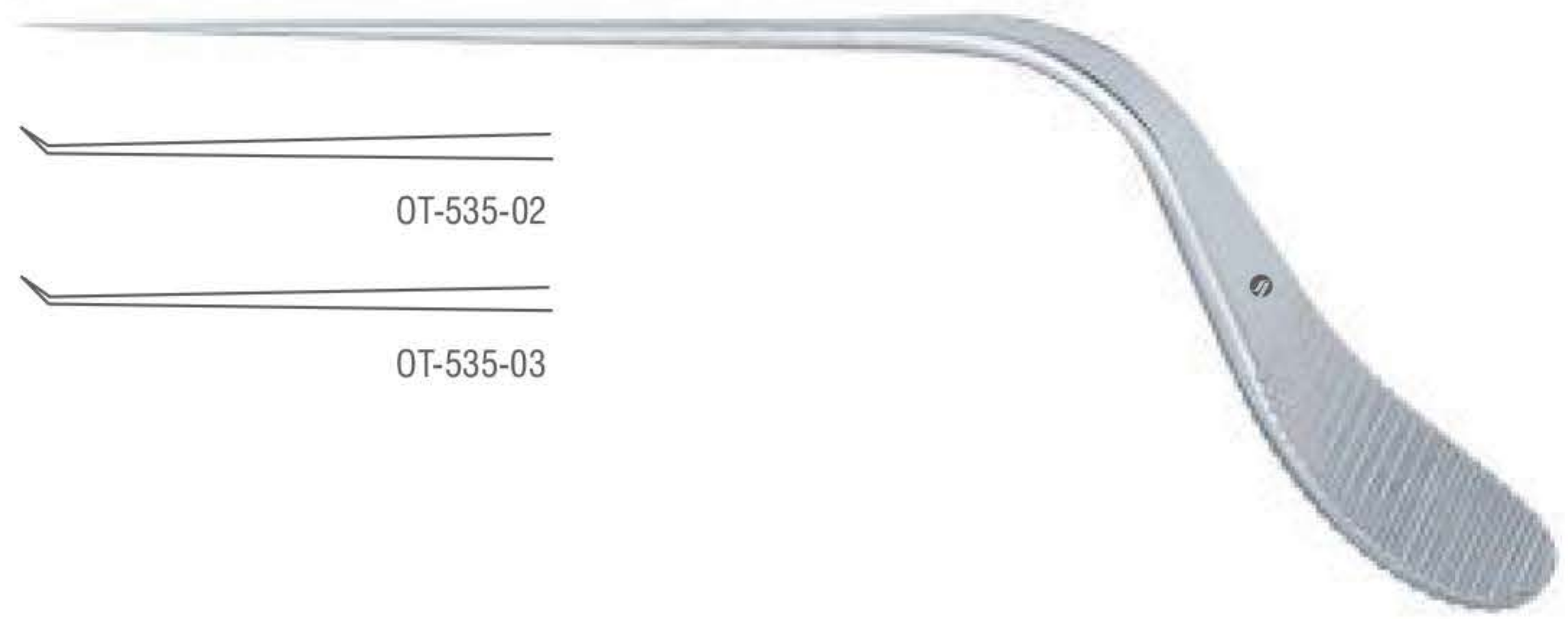

Catalog #	Size, Tip Size
OT-535-02	13.5 cm (5 1/2"), 0.5 mm
OT-535-03	13.5 cm (5 1/2"), 1.0 mm

OT-535-02

OT-535-03

Zoellner Micro Ear Needle
 Angled 45° Downwards

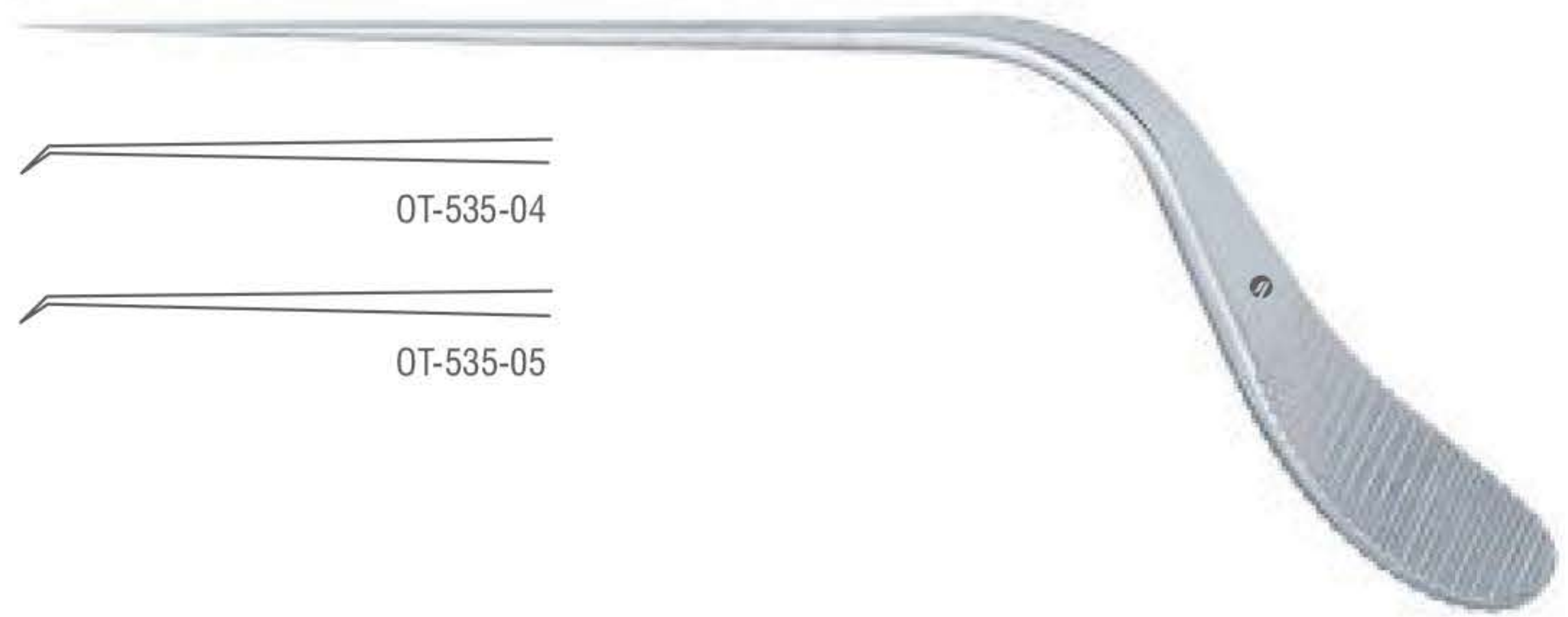

Catalog #	Size, Tip Size
OT-535-04	13.5 cm (5 1/2"), 0.5 mm
OT-535-05	13.5 cm (5 1/2"), 1.0 mm

OT-535-04

OT-535-05

Zoellner Micro Ear Needle
 Angled 90° Upwards



Catalog #	Size, Tip Size
OT-535-06	13.5 cm (5 1/2"), 0.5 mm

Zoellner Micro Ear Needle
 Angled 90° Downwards



Catalog #	Size, Tip Size
OT-535-07	13.5 cm (5 1/2"), 0.5 mm

Micro Dissectors
 Mikro-Dissektoren
 Micro disecadores
 Micro Dissecteurs
 Micro Dissettori

Zoellner Micro Ear Needle
 For Footplate

Catalog #	Size, Tip Size
OT-535-08	13.5 cm (5 1/2"), 1.0 mm
OT-535-09	13.5 cm (5 1/2"), 1.0 mm

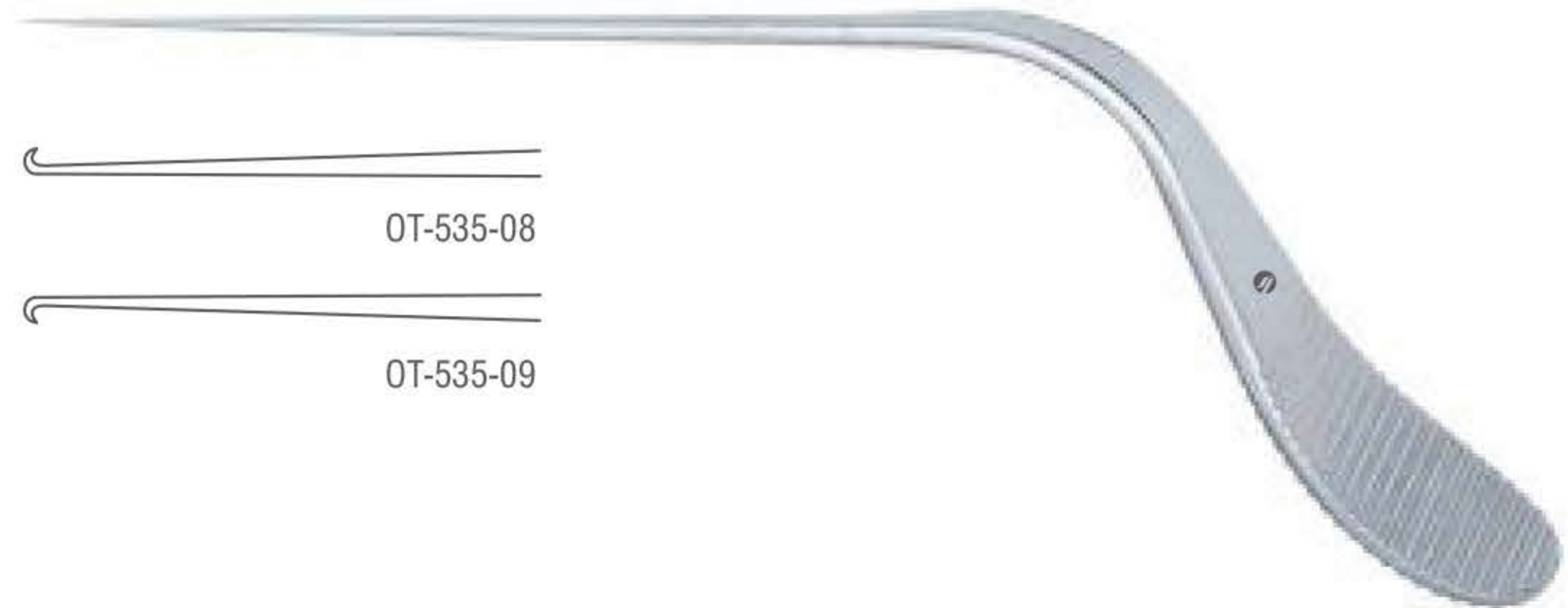

Zoellner Ear Knife
 Angled 90° Upwards

Catalog #	Size
OT-535-10	13.5 cm (5 1/2")



Zoellner Ear Knife
 Angled 90° Downwards

Catalog #	Size
OT-535-11	13.5 cm (5 1/2")



Zoellner Micro Ear Knife
 Angled Upwards

Catalog #	Size
OT-535-12	13.5 cm (5 1/2")



Zoellner Micro Ear Knife
 Angled Downwards

Catalog #	Size
OT-535-13	13.5 cm (5 1/2")



Micro Dissectors
 Mikro-Dissektoren
 Micro disecadores
 Micro Dissecteurs
 Micro Dissettori

Zoellner Tympanum Needle
 Angled Upwards



Catalog #	Size
OT-535-14	13.5 cm (5 1/2")

Zoellner Tympanum Needle
 Angled Downwards



Catalog #	Size
OT-535-15	13.5 cm (5 1/2")

Zoellner Raspatory



Catalog #	Size
OT-535-16	13.5 cm (5 1/2")
OT-535-17	13.5 cm (5 1/2")

Zoellner Application Instrument



Catalog #	Size
OT-535-18	Standard

Ear Cures
 Ohrkurreten
 Curetas auriculares
 Cures auriculaires
 Curette auricolari

Langenbeck Ear Curette
 Blunt

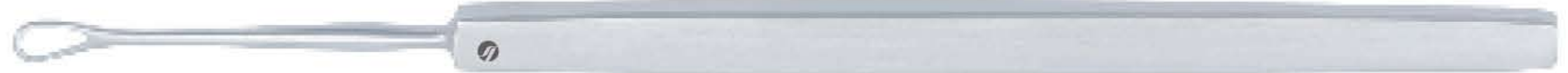
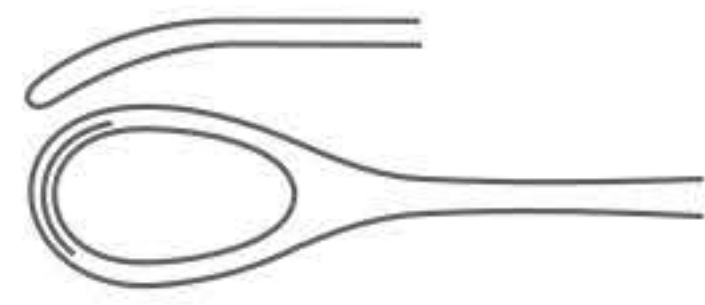

Catalog #	Size
OT-551-13	13 cm (5")

Shapleigh Ear Curette



Catalog #	Size, Profile
OT-555-01	15 cm (6"), Fig. 1
OT-555-02	15 cm (6"), Fig. 2

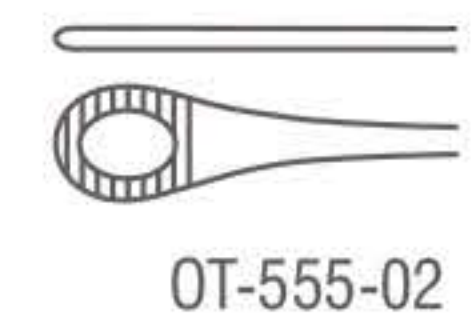

Buck Ear Curette
 Straight, Blunt

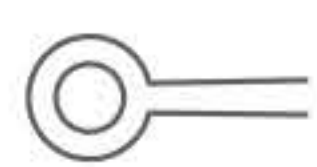

Catalog #	Size, Profile
OT-570-01	17 cm (6 3/4"), Fig. 000
OT-570-02	17 cm (6 3/4"), Fig. 00
OT-570-10	17 cm (6 3/4"), Fig. 0
OT-570-11	17 cm (6 3/4"), Fig. 1
OT-570-12	17 cm (6 3/4"), Fig. 2
OT-570-13	17 cm (6 3/4"), Fig. 3
OT-570-14	17 cm (6 3/4"), Fig. 4

