



# NJ ENTERPRISES



General Microsurgery  
Instruments

Scalpel Handles  
 Skalpellgriffe  
 Mangos de bisturíes  
 Manches pour bistouris  
 Manici per bisturi

**Scalpel Handle # 3**

Solid



Catalog #	Size
SL-010-03	12 cm (4 3/4")

**Scalpel Handle # 4**

Solid



Catalog #	Size
SL-010-04	13.5 cm (5 1/4")

**Scalpel Handle # 3 & 4**

Solid, Double Ended



Catalog #	Size
SL-010-34	16 cm (6 1/4")

**Scalpel Handle # 3**

Solid, CM Graduation



Catalog #	Size
SL-012-03	12 cm (4 3/4")

**Scalpel Handle # 3L**

Solid, Long



Catalog #	Size
SL-020-13	21.5 cm (8 1/2")

Scalpel Handles  
 Skalpelligriffe  
 Mangos de bisturíes  
 Manches pour bistouris  
 Manici per bisturi

**Scalpel Handle # 4L**  
 Solid, Long



Catalog #	Size
SL-020-14	21 cm (8 1/4")

**Scalpel Handle # 3L**  
 Solid, Angled, Long



Catalog #	Size
SL-021-13	21 cm (8 1/4")

**Scalpel Handle # 4L**  
 Solid, Angled, Long



Catalog #	Size
SL-021-14	21 cm (8 1/4")

**Scalpel Handle # 7**  
 Solid



Catalog #	Size
SL-030-07	16 cm (6 1/4")

**Scalpel Handle # 7K**  
 Solid, Short



Catalog #	Size
SL-030-17	12.5 cm (5")

Scalpel Handles  
 Skalpellgriffe  
 Mangos de bisturíes  
 Manches pour bistouris  
 Manici per bisturi

**Collin Scalpel Handle # 8**  
 With Hollow Handle



Catalog #	Size
SL-032-08	13.5 cm (5 1/4")

**Collin Scalpel Handle # 9**  
 With Hollow Handle



Catalog #	Size
SL-032-09	14.5 cm (5 3/4")

**Scalpel Handle # 3**  
 With Round Hollow Handle



Catalog #	Size
SL-050-03	15.5 cm (6")

**Scalpel Handle # 3**  
 Solid, Round Handle



Catalog #	Size
SL-052-03	14.5 cm (5 3/4")

**Scalpel Handle # 3**  
 Solid, Round Handle, Angled



Catalog #	Size
SL-053-03	14 cm (5 1/2")

Scalpel Blades  
 Skalpellklingen  
 Hojas de bisturíes  
 Lames pour bistouris  
 Lame per bisturi

**Kaye Scalpel Handle # 3**  
 Solid, Round Handle



Catalog #	Size
SL-056-03	15 cm (6")

**Scalpel Blade # 10**  
 Pack of 100

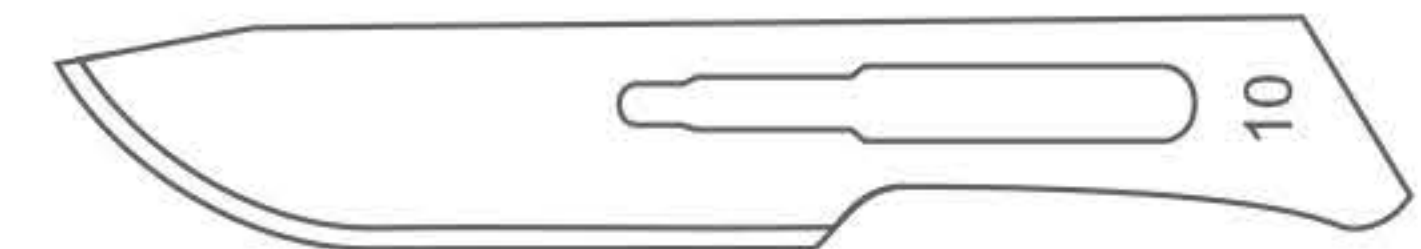

Catalog #	Shape
SL-100-10	Fig. 10

**Scalpel Blade # 11**  
 Pack of 100

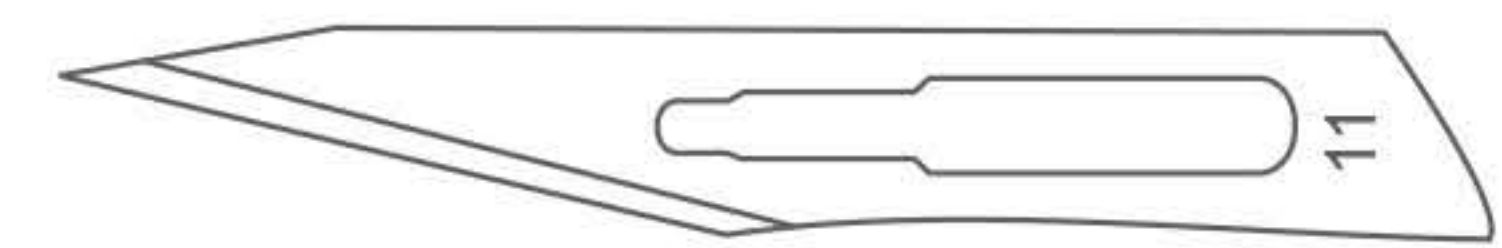

Catalog #	Shape
SL-100-11	Fig. 11

**Scalpel Blade # 12**  
 Pack of 100

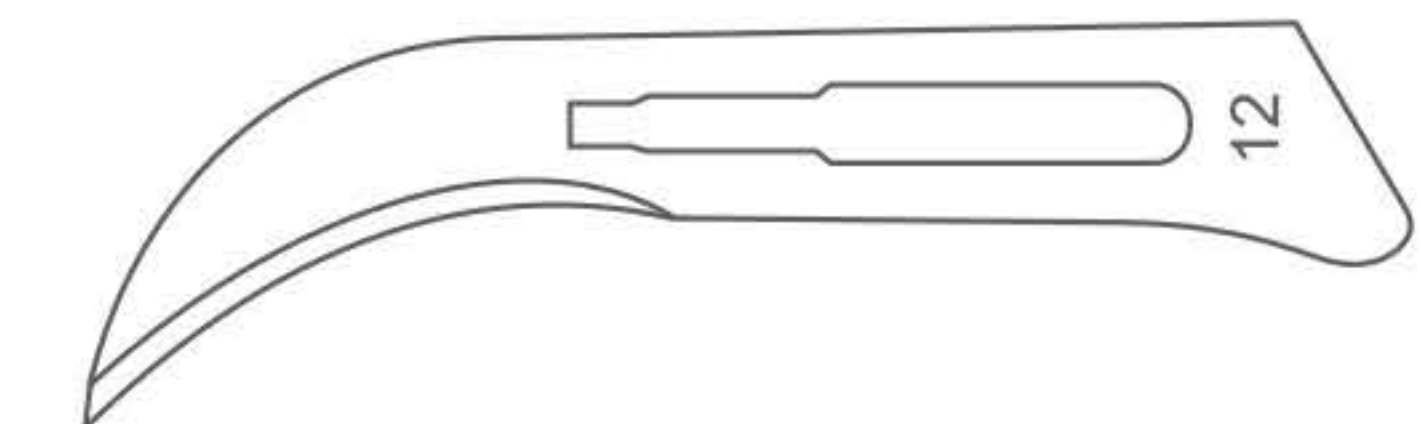

Catalog #	Shape
SL-100-12	Fig. 12

**Scalpel Blade # 13**  
 Pack of 100

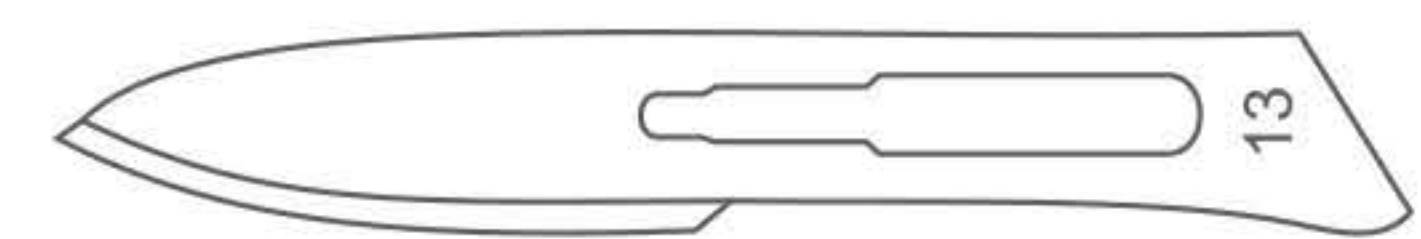

Catalog #	Shape
SL-100-13	Fig. 13

Scalpel Blades  
 Skalpellklingen  
 Hojas de bisturíes  
 Lames pour bistouris  
 Lame per bisturi

**Scalpel Blade # 15**  
 Pack of 100

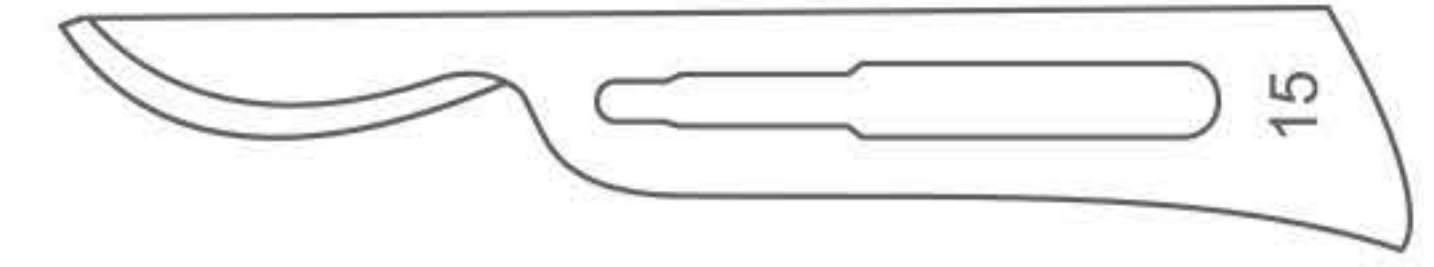

Catalog #	Shape
SL-100-15	Fig. 15

**Scalpel Blade # 16**  
 Pack of 100

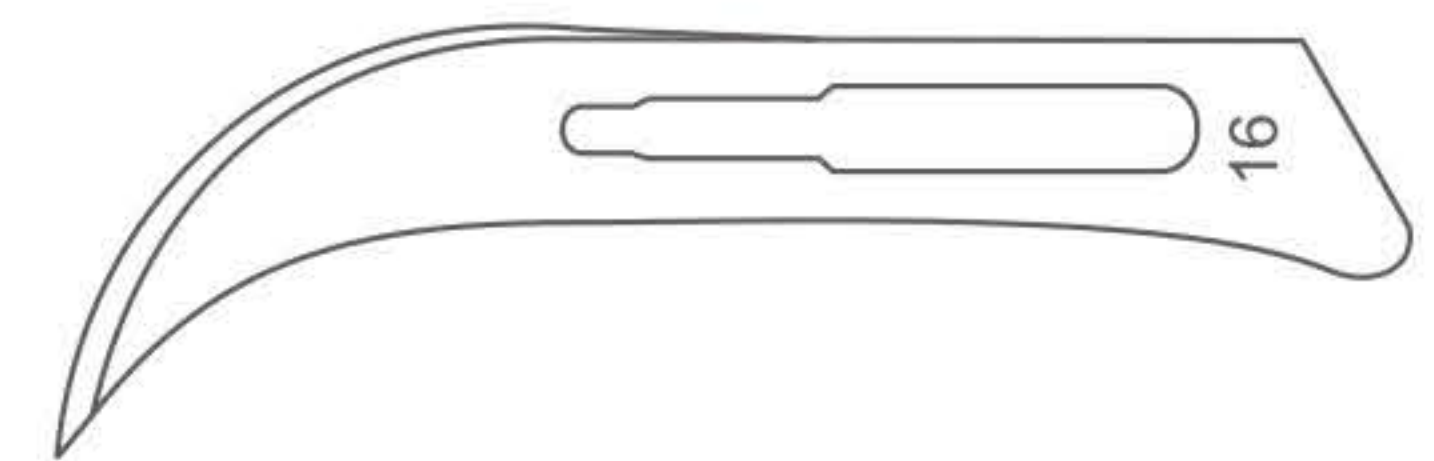

Catalog #	Shape
SL-100-16	Fig. 16

**Scalpel Blade # 17**  
 Pack of 100

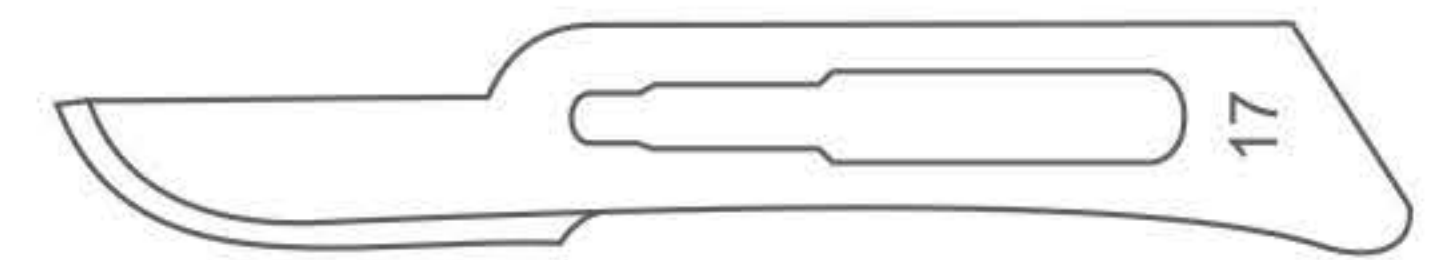

Catalog #	Shape
SL-100-17	Fig. 17

**Scalpel Blade # 18**  
 Pack of 100

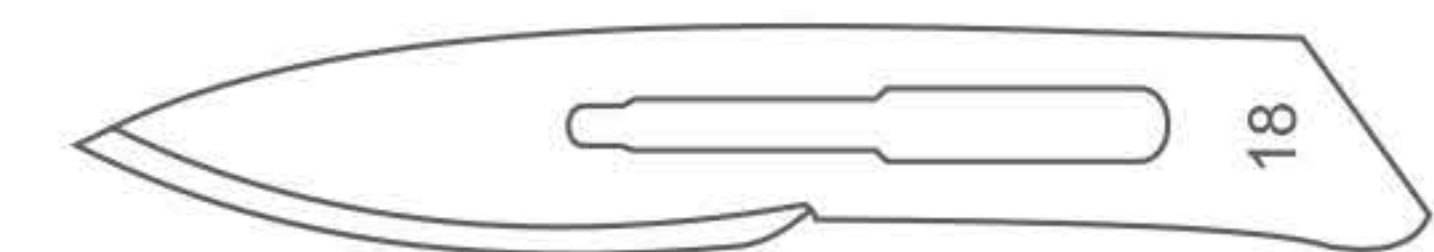

Catalog #	Shape
SL-100-18	Fig. 18

**Scalpel Blade # 19**  
 Pack of 100

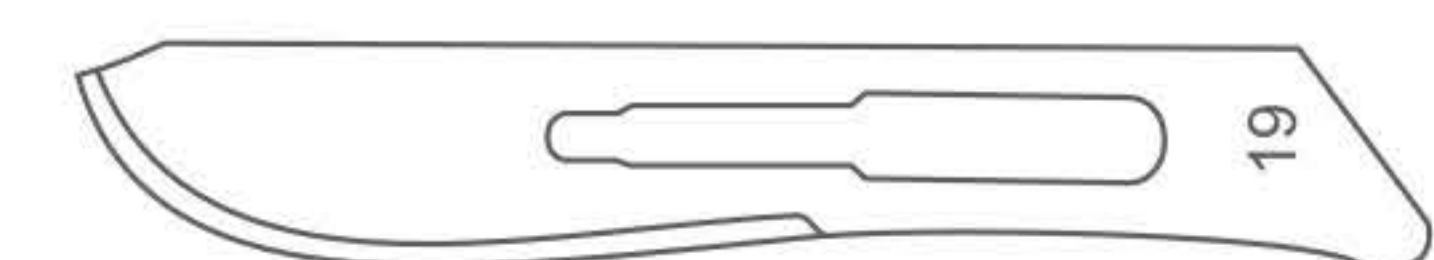

Catalog #	Shape
SL-100-19	Fig. 19

Scalpel Blades  
 Skalpellklingen  
 Hojas de bisturíes  
 Lames pour bistouris  
 Lame per bisturi

**Scalpel Blade # 20**  
 Pack of 100

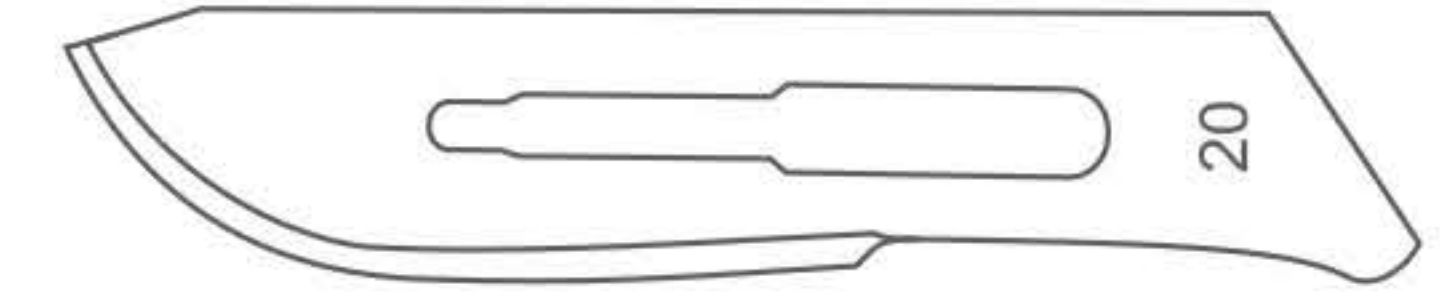

Catalog #	Shape
SL-100-20	Fig. 20

**Scalpel Blade # 21**  
 Pack of 100

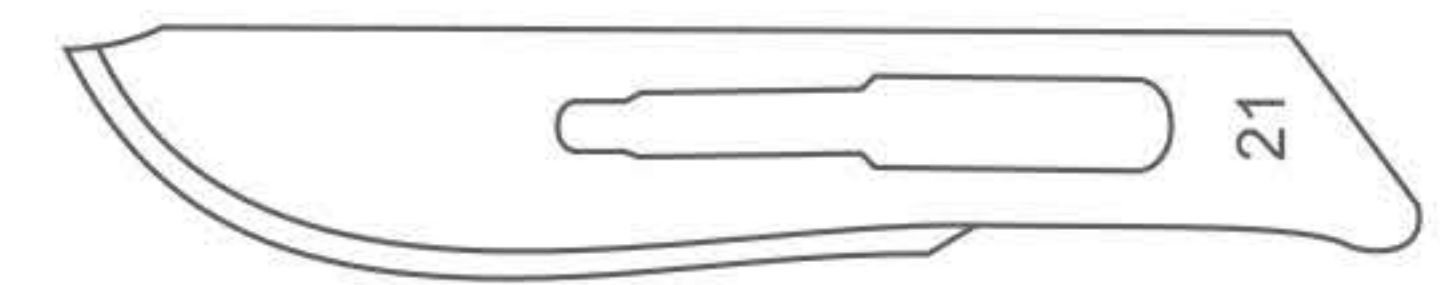

Catalog #	Shape
SL-100-21	Fig. 21

**Scalpel Blade # 22**  
 Pack of 100

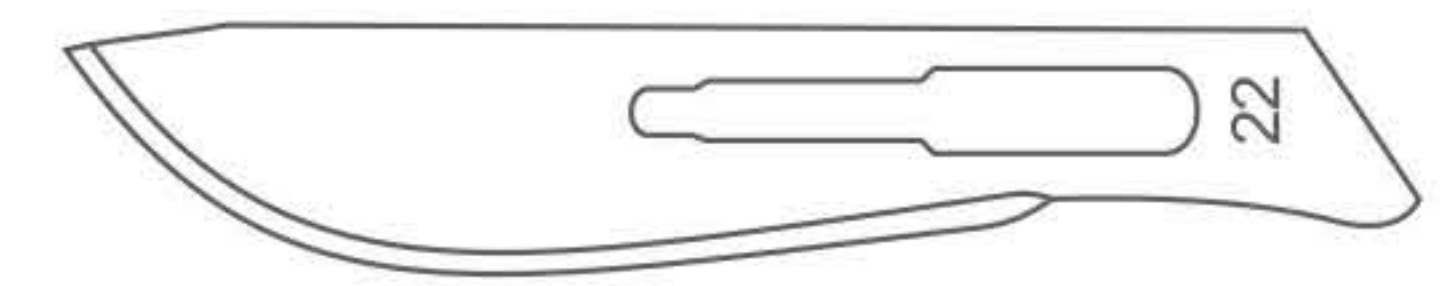

Catalog #	Shape
SL-100-22	Fig. 22

**Scalpel Blade # 23**  
 Pack of 100

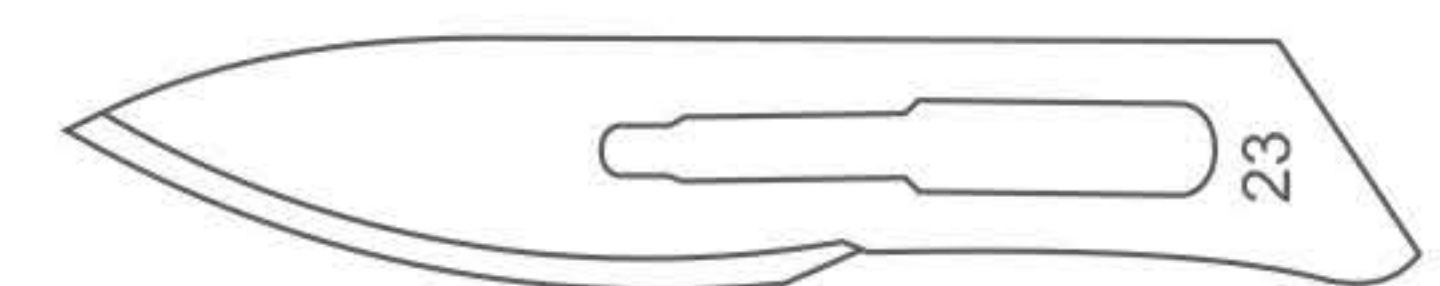

Catalog #	Shape
SL-100-23	Fig. 23

**Scalpel Blade # 24**  
 Pack of 100

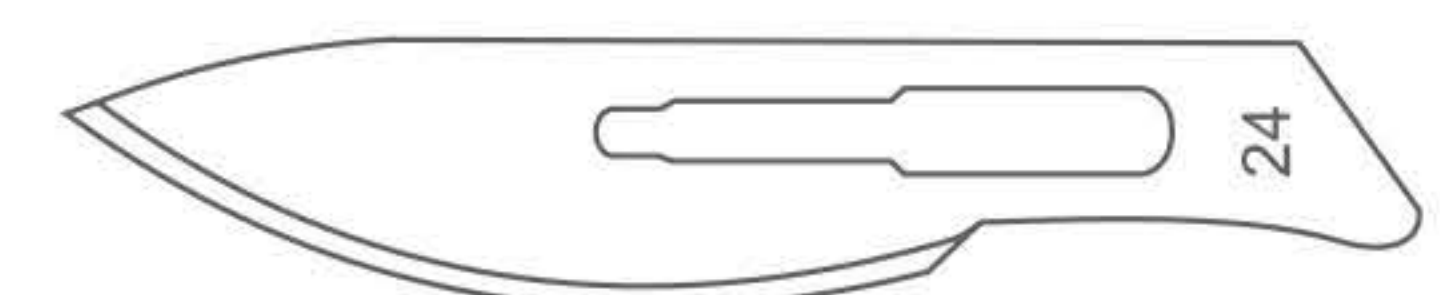

Catalog #	Shape
SL-100-24	Fig. 24

Scalpel Blades  
 Skalpellklingen  
 Hojas de bisturios  
 Lames pour bistouris  
 Lame per bisturi

**Scalpel Blade # 34**  
 Pack of 100

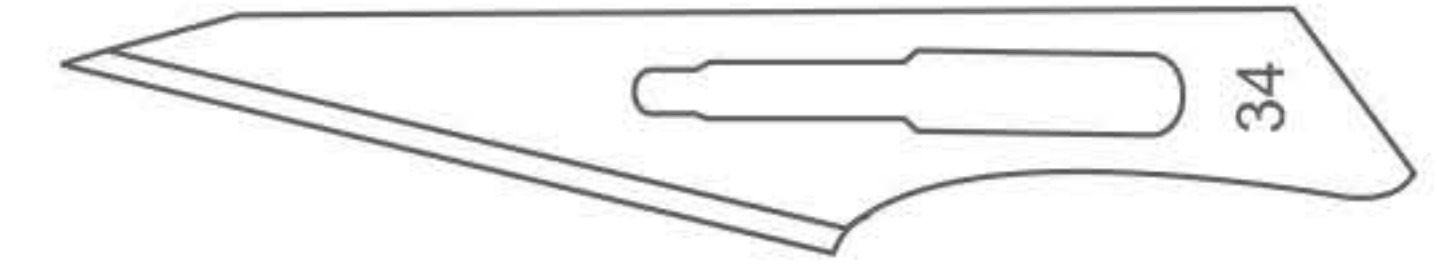

Catalog #	Shape
SL-100-34	Fig. 34

**Scalpel Blade # 12D**  
 Pack of 100

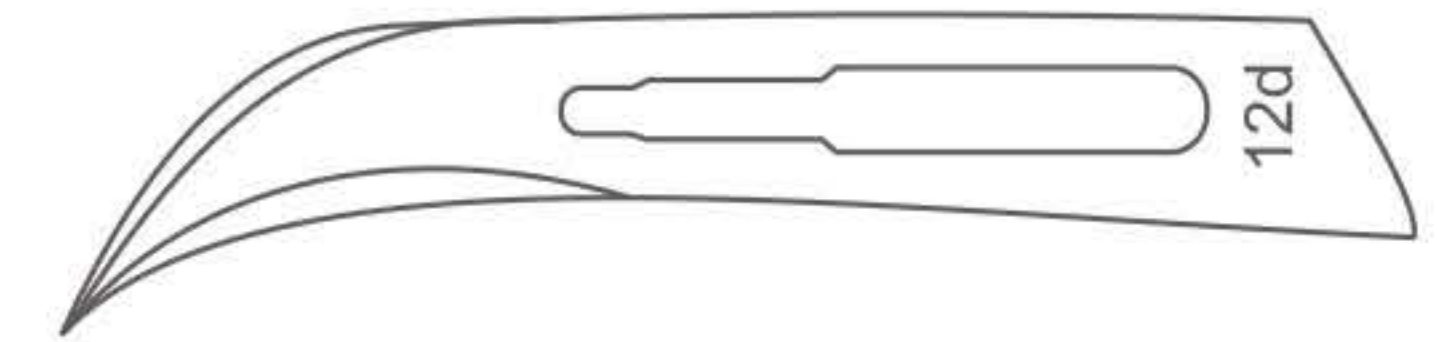

Catalog #	Shape
SL-101-12	Fig. 12D

**Scalpel Blade # 15C**  
 Pack of 100

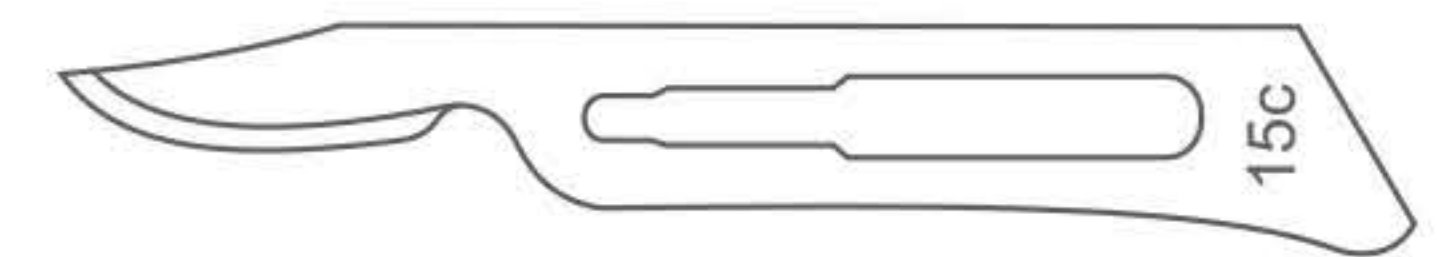

Catalog #	Shape
SL-101-15	Fig. 15C

**Scalpel Blade # 36**  
 Pack of 100

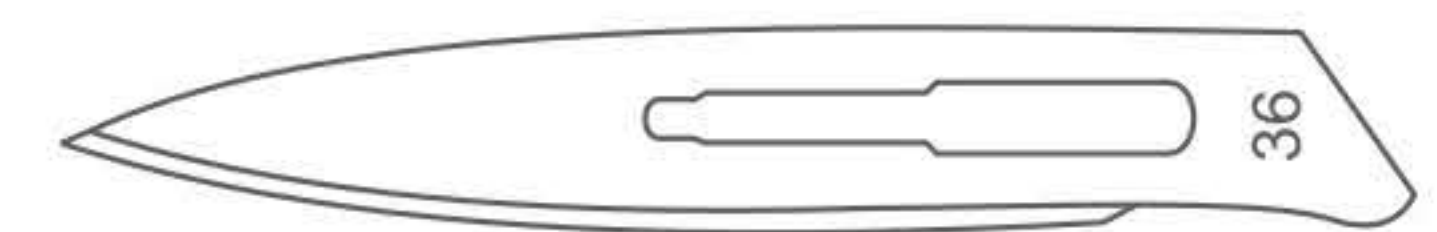

Catalog #	Shape
SL-100-36	Fig. 36

**Scalpel Blade Remover**



Catalog #	Size
SL-150-00	Standard

Scalpel Blades  
 Skalpellklingen  
 Hojas de bisturíes  
 Lames pour bistouris  
 Lame per bisturi

**Scalpel Handle**

For Micro Scalpel Blades, Titanium



Catalog #	Size
SL-200-00	13.5 cm (5 1/4")

**Scalpel Handle**

For Micro Scalpel Blades, Stainless Steel



Catalog #	Size
SL-202-00	13.5 cm (5 1/4")

**Caspar Scalpel Handle**



Catalog #	Size
SL-204-00	18 cm (7")

**Scalpel Handle**

For Micro Scalpel Blades



Catalog #	Size
SL-206-10	10 cm (4")
SL-206-13	13 cm (5")
SL-206-15	15 cm (6")

**Landolt Scalpel Handle**

Bayonet Shaped, Round Handle



Catalog #	Size
SL-207-00	25 cm (10")

Scalpel Blades  
 Skalpellklingen  
 Hojas de bisturios  
 Lames pour bistouris  
 Lame per bisturi

**Landolt Scalpel Handle**  
 Bayonet Shaped, Square Handle



Catalog #	Size
SL-209-00	21 cm (8 1/4")

**Micro Scalpel Blade # 61**  
 Pack of 25



Catalog #	Shape
SL-210-61	Fig. 61

**Micro Scalpel Blade # 62**  
 Pack of 25



Catalog #	Shape
SL-210-62	Fig. 62

**Micro Scalpel Blade # 63**  
 Pack of 25



Catalog #	Shape
SL-210-63	Fig. 63

**Micro Scalpel Blade # 64**  
 Pack of 25



Catalog #	Shape
SL-210-64	Fig. 64

Scalpel Blades  
 Skalpellklingen  
 Hojas de bisturíes  
 Lames pour bistouris  
 Lame per bisturi

**Micro Scalpel Blade # 65**

Pack of 25



Catalog #	Shape
SL-210-65	Fig. 65

**Micro Scalpel Blade # 66**

Pack of 25

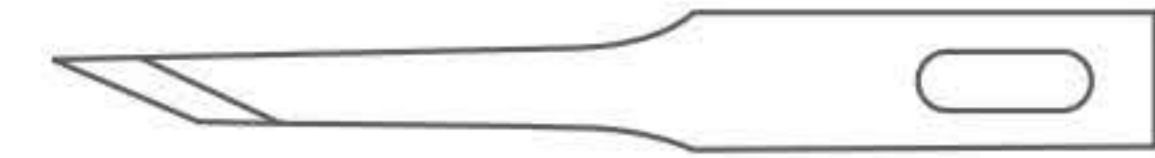

Catalog #	Shape
SL-210-66	Fig. 66

**Micro Scalpel Blade # 67**

Pack of 25



Catalog #	Shape
SL-210-67	Fig. 67

**Micro Scalpel Blade # 68**

Pack of 25

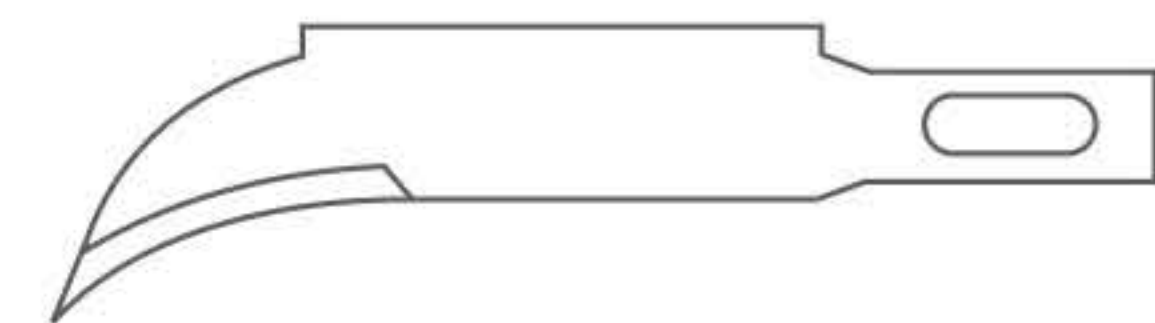

Catalog #	Shape
SL-210-68	Fig. 68

**Micro Scalpel Blade # 69**

Pack of 25



Catalog #	Shape
SL-210-69	Fig. 69

Operating Knives  
 Operating Skalpelle  
 Bisturías para operaciones  
 Bistouris pour opérations  
 Bisturi per interventi

**Operating Knife**  
 With Metal Handle, Blade Size 35 mm

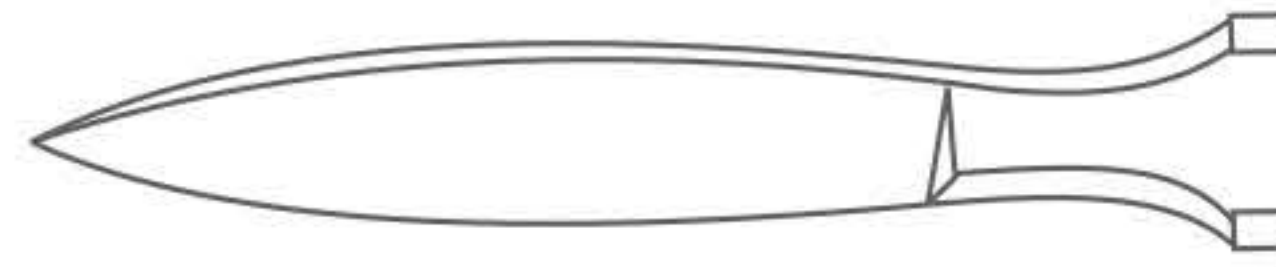

Catalog #	Size
SL-300-07	15 cm (6")

**Operating Knife**  
 With Metal Handle, Blade Size 40 mm

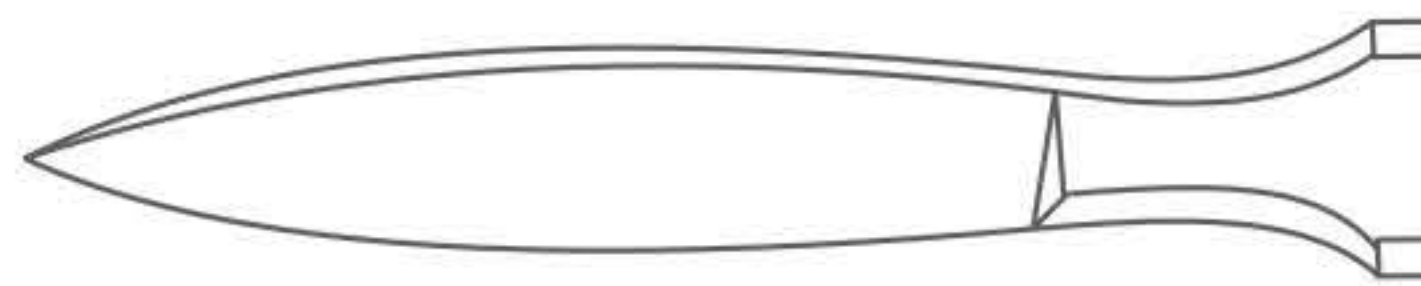

Catalog #	Size
SL-300-08	16 cm (6 1/4")

**Operating Knife**  
 With Metal Handle, Blade Size 30 mm

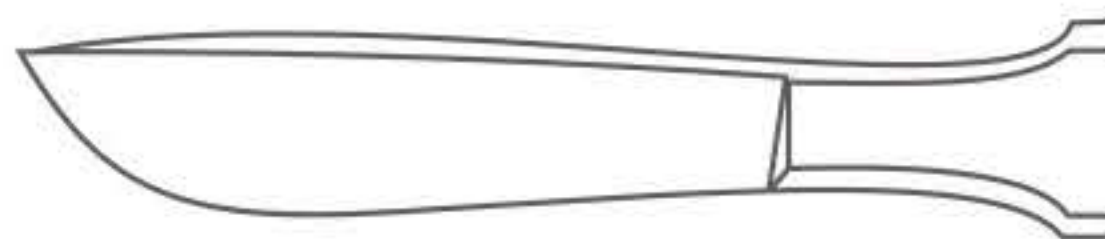

Catalog #	Size
SL-300-01	15 cm (6")

**Operating Knife**  
 With Metal Handle, Blade Size 36 mm



Catalog #	Size
SL-300-02	15 cm (6")

**Operating Knife**  
 With Metal Handle, Blade Size 40 mm



Catalog #	Size
SL-300-03	15.5 cm (6")

Operating Knives  
 Operating Skalpelle  
 Bisturíes para operaciones  
 Bistouris pour opérations  
 Bisturi per interventi

**Operating Knife**

With Metal Handle, Blade Size 45 mm

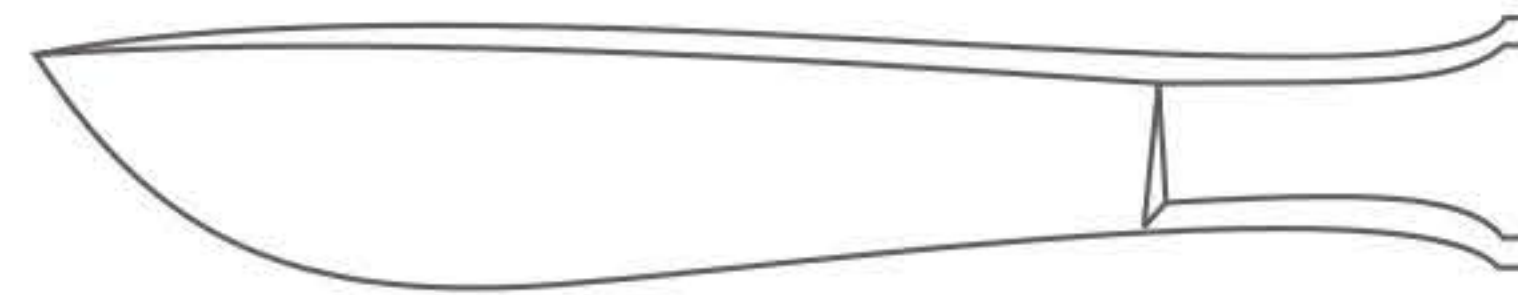

Catalog #	Size
SL-300-04	16 cm (6 1/4")

**Operating Knife**

With Metal Handle, Blade Size 50 mm

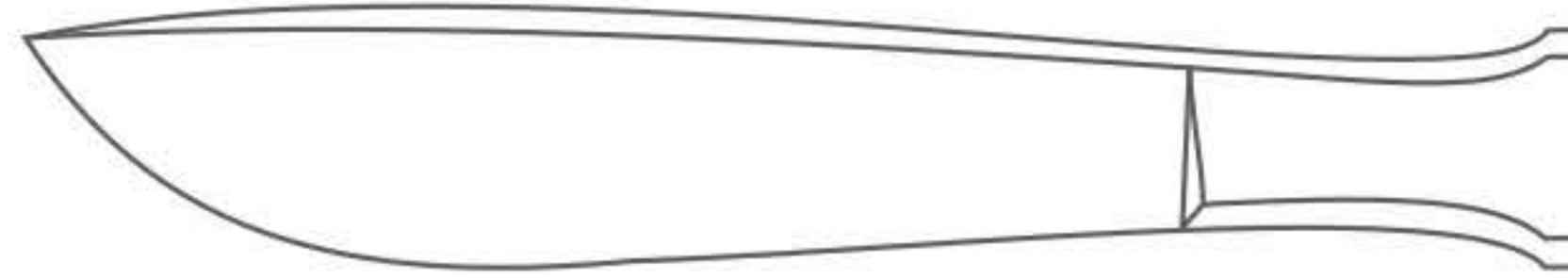

Catalog #	Size
SL-300-05	16 cm (6 1/4")

**Operating Knife**

With Metal Handle, Blade Size 27 mm

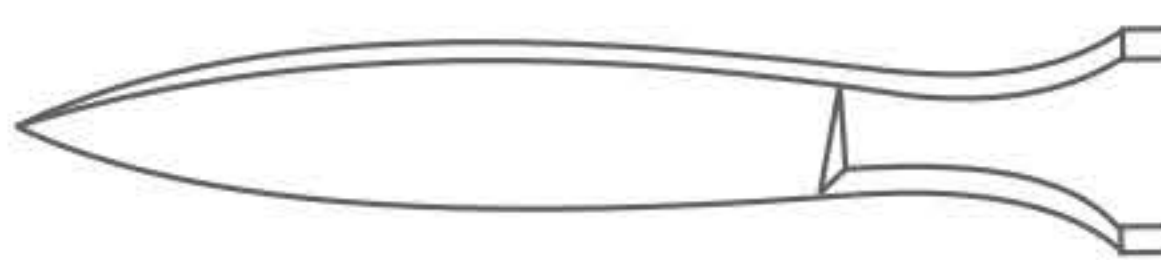

Catalog #	Size
SL-300-06	15 cm (6")

**Operating Knife**

With Metal Handle, Blade Size 47 mm



Catalog #	Size
SL-300-09	16 cm (6 1/4")

**Operating Knife**

With Metal Handle, Blade Size 50 mm



Catalog #	Size
SL-300-10	17 cm (6 3/4")

Operating Knives  
 Operating Skalpelle  
 Bisturías para operaciones  
 Bistouris pour opérations  
 Bisturi per interventi

**Dieffenbach Operating Knife**  
 With Metal Handle

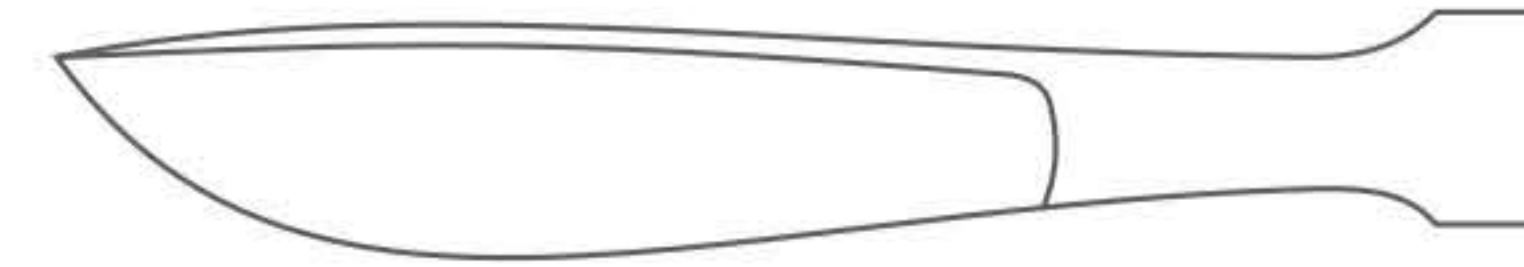

Catalog #	Size
SL-310-01	17 cm (6 3/4")

**Dieffenbach Operating Knife**  
 With Metal Handle

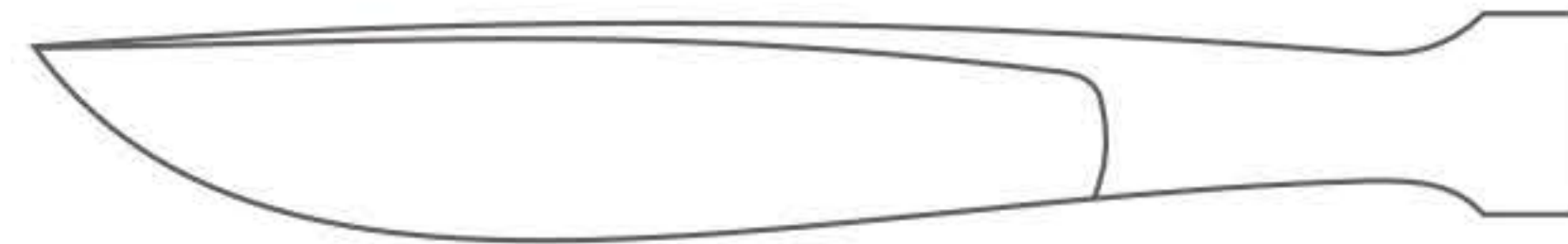

Catalog #	Size
SL-310-02	17 cm (6 3/4")

**Dieffenbach Operating Knife**  
 With Metal Handle

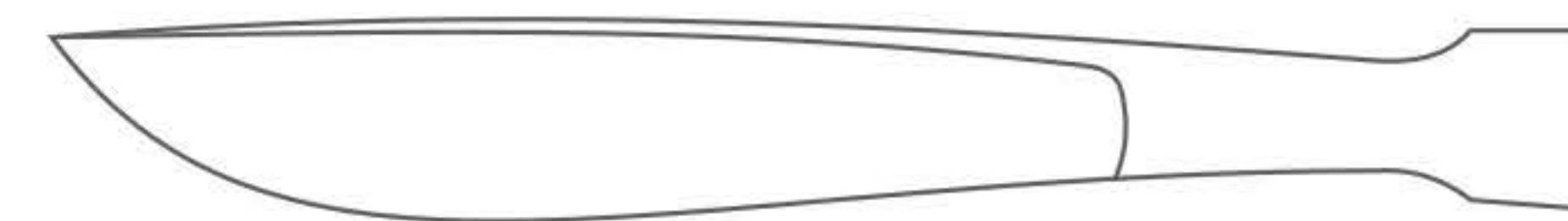

Catalog #	Size
SL-310-03	17 cm (6 3/4")

**Dieffenbach Operating Knife**  
 With Metal Handle



Catalog #	Size
SL-310-04	17 cm (6 3/4")

**Dieffenbach Operating Knife**  
 With Metal Handle



Catalog #	Size
SL-310-05	17 cm (6 3/4")

Operating Knives  
 Operating Skalpelle  
 Bisturías para operaciones  
 Bistouris pour opérations  
 Bisturi per interventi

**Dieffenbach Operating Knife**  
 With Metal Handle



Catalog #	Size
SL-310-06	17 cm (6 ¾")

**Dieffenbach Operating Knife**  
 With Metal Handle

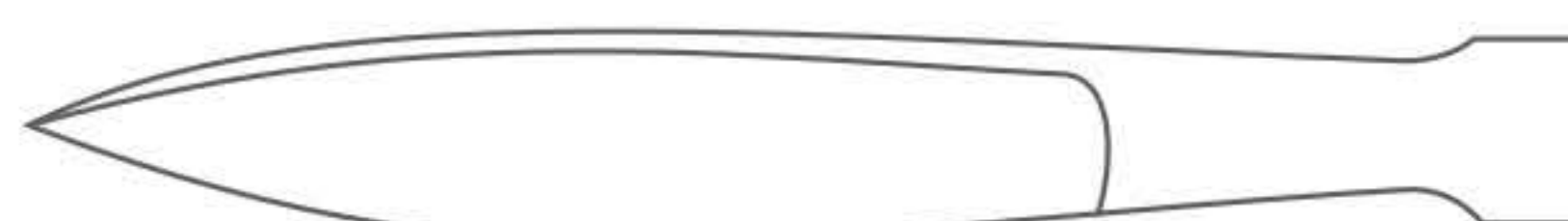

Catalog #	Size
SL-310-07	17 cm (6 ¾")

**Dieffenbach Operating Knife**  
 With Metal Handle

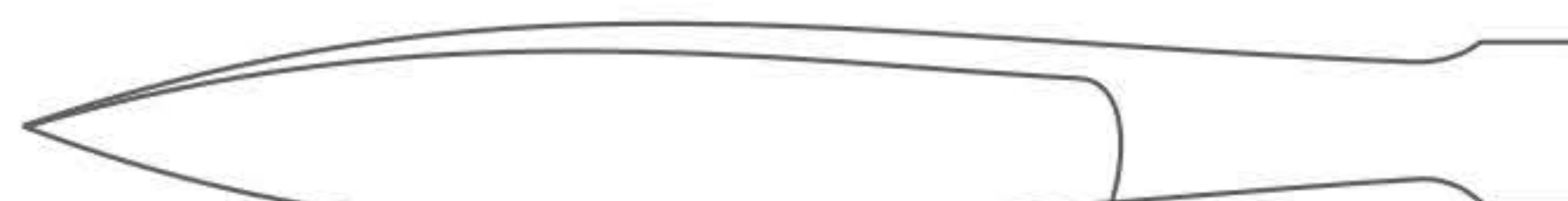

Catalog #	Size
SL-310-08	17 cm (6 ¾")

**Dieffenbach Operating Knife**  
 With Metal Handle



Catalog #	Size
SL-310-09	17 cm (6 ¾")

**Dieffenbach Operating Knife**  
 With Metal Handle



Catalog #	Size
SL-310-15	17 cm (6 ¾")

Operating Knives  
 Operating Skalpelle  
 Bisturíes para operaciones  
 Bistouris pour opérations  
 Bisturi per interventi

**Dieffenbach Operating Knife**  
 With Metal Handle

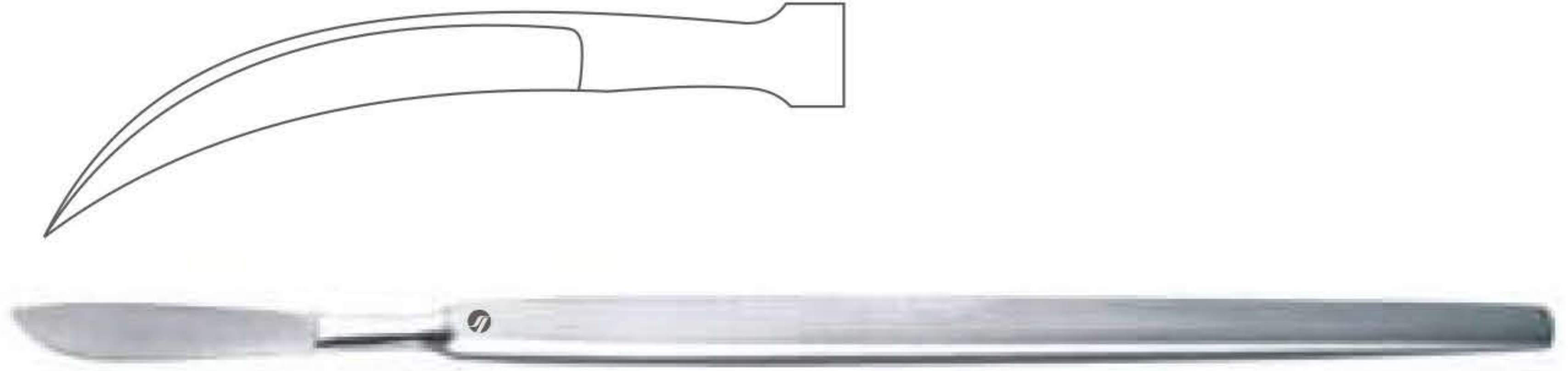

Catalog #	Size
SL-310-16	17 cm (6 ¾")

**Bergmann Operating Knife**  
 With Metal Handle



Catalog #	Size
SL-320-14	14 cm (5 ½")

**Operating Knife**  
 Bellied Blade, Fig. 1

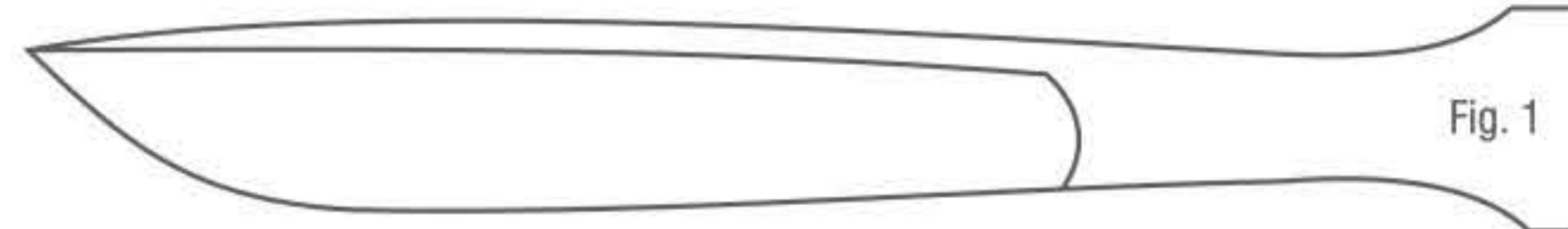

Catalog #	Size
SL-350-01	14 cm (5 ½")

**Operating Knife**  
 Bellied Blade, Fig. 3

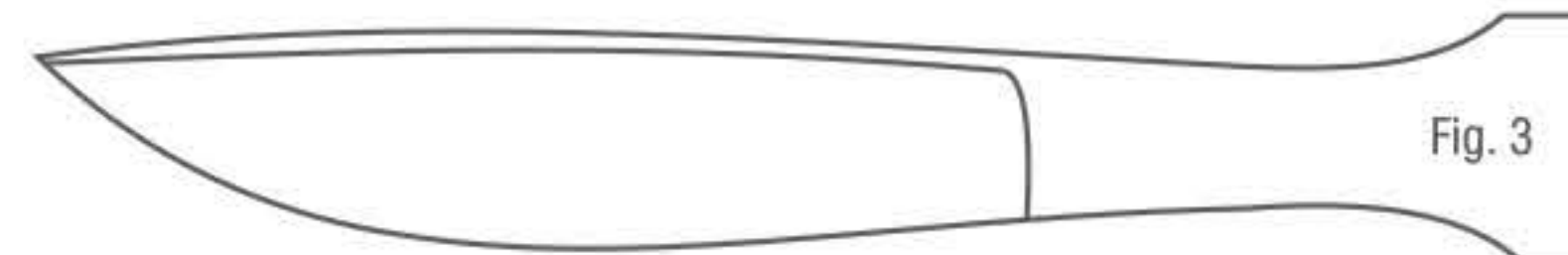

Catalog #	Size
SL-350-03	14 cm (5 ½")

**Operating Knife**  
 Bellied Blade, Fig. 4



Catalog #	Size
SL-350-04	14 cm (5 ½")

Operating Knives  
 Operating Skalpelle  
 Bisturías para operaciones  
 Bistouris pour opérations  
 Bisturi per interventi

**Operating Knife**  
 Bellied Blade, Fig. 6



Catalog #	Size
SL-350-06	14 cm (5 1/2")

**Operating Knife**  
 Bellied Blade, Fig. 7



Catalog #	Size
SL-350-07	14 cm (5 1/2")

**Operating Knife**  
 Bellied Blade, Fig. 8



Catalog #	Size
SL-350-08	14 cm (5 1/2")

**Operating Knife**  
 Bellied Blade, Fig. 9



Catalog #	Size
SL-350-09	14 cm (5 1/2")

**Operating Knife**  
 Sharp Pointed Blade, Fig. 14

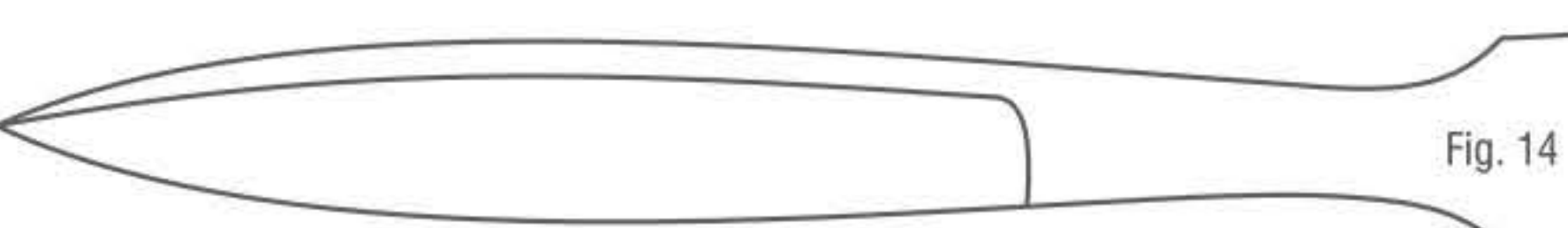

Catalog #	Size
SL-350-14	14 cm (5 1/2")

Operating Knives, Post Mortem Knives  
 Operating Skalpelle, Organmesser  
 Bisturíes para operaciones, Cuchillos para órganos  
 Bistouris pour opérations, Couteaux à autopsie  
 Bisturi per interventi, Coltli per autopsia

**Operating Knife**

Sickle Shaped Blade, Fig. 46

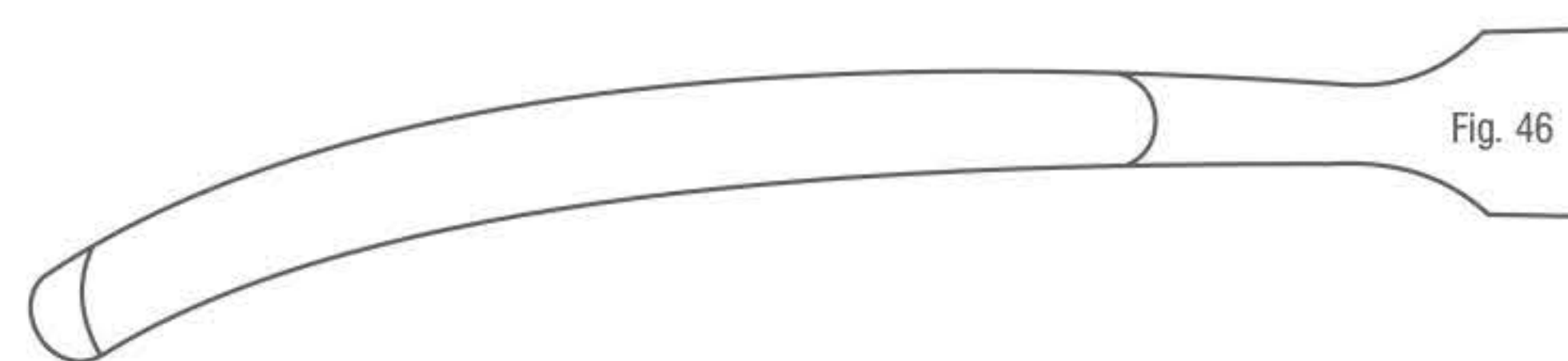

Catalog #	Size
SL-361-46	14 cm (5 1/2")



**Operating Knife**

Tenotome, Fig. 63

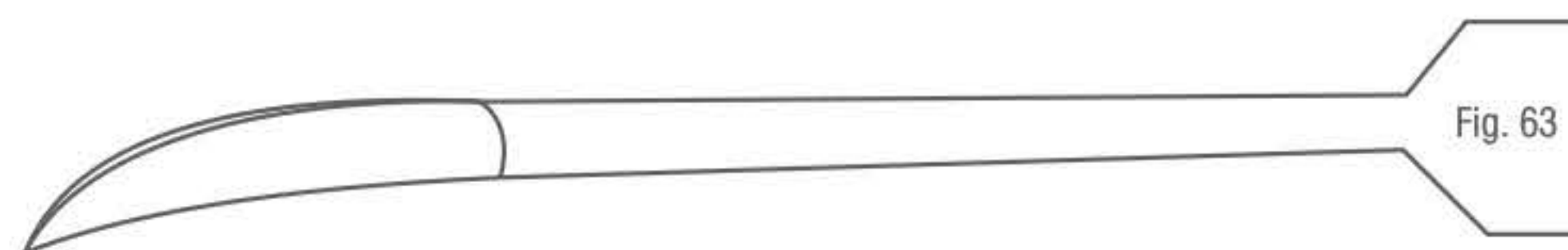

Catalog #	Size
SL-363-63	14 cm (5 1/2")



**Virchow Autopsy Knife**

With Wooden Handle, Blade Size 100 mm



Catalog #	Size
SL-400-10	25.5 cm (10")

**Virchow Cartilage Knife**

With Wooden Handle, Blade Size 80 mm



Catalog #	Size
SL-402-08	21 cm (8 1/4")

Post Mortem Knives, Brain Knives, Amputation Knives  
 Organmesser, Hirnmesser, Amputationsmesser  
 Cuchillos para órganos, Cuchillos para cerebro, Cuchillos para amputación  
 Couteaux à autopsie, Couteaux à cerveaux, Couteaux à amputation  
 Coltli per autopsia, Coltelli per cervello, Coltelli per amputazione

**Walb Post Mortem Knife**  
 With Wooden Handle



Catalog #	Size
SL-410-11	26 cm (10 ¼"), Blade Size 110 mm
SL-410-14	29 cm (11 ½"), Blade Size 140 mm
SL-410-17	31 cm (12 ¼"), Blade Size 170 mm

**Virchow Brain Knife**  
 With Hollow Handle



Catalog #	Size
SL-420-16	26 cm (10 ¼"), Blade Size 160 mm
SL-420-20	33.5 cm (13 ¼"), Blade Size 200 mm
SI-420-24	38 cm (15"), Blade Size 240 mm

**Liston Amputation Knife**  
 With Hollow Handle



Catalog #	Size
SL-450-13	26 cm (10 ¼"), Blade Size 130 mm
SL-450-16	29 cm (11 ½"), Blade Size 160 mm
SL-450-19	32.5 cm (12 ¾"), Blade Size 190 mm
SL-450-22	35 cm (13 ¾"), Blade Size 220 mm

Amputation Knives  
 Amputationsmesser  
 Cuchillos para amputación  
 Couteaux à amputation  
 Coltelli per amputazione

**Catlin Amputation Knife**

With Hollow Handle, Blade Size 160 mm



Catalog #	Size
SL-460-16	29 cm (11 1/2")

**Langenbeck Flap Knife**

Blade Size 120 mm



Catalog #	Size
SL-470-12	25 cm (9 3/4")

**Phalangeal Knife**

Blade Size 105 mm



Catalog #	Size
SL-472-10	23.5 cm (9 1/4")

**Interosseous Knife**

Blade Size 110 mm



Catalog #	Size
SL-474-11	24 cm (9 1/2")

**Resection Knife**

Solid Handle, Dissecting End, Blade Size 65 mm



Catalog #	Size
SL-480-65	19 cm (7 1/2")

Amputation Knives, Fistula Knives  
 Amputationsmesser, Fistelmesser  
 Cuchillos para amputación, Bisturíes para fistulas  
 Couteaux à amputation, Bistouris à fistules  
 Coltelli per amputazione, Bisturi per fistole

**Langenbeck Resection Knife**

Blade Size 55 mm



Catalog #	Size
SL-482-55	18 cm (7")

**Langenbeck Resection Knife**

Blade Size 55 mm



Catalog #	Size
SL-484-55	18 cm (7")

**Simon Fistula Knife**

Fig. 1



SL-488-01, Fig. 1



SL-488-02, Fig. 2



SL-488-03, Fig. 3

Catalog #	Size, Profile
SL-488-01	20 cm (8"), Fig. 1
SL-488-02	20 cm (8"), Fig. 2
SL-488-03	20 cm (8"), Fig. 3



**Ulrich Fistula Knife**



Catalog #	Size
SL-490-22	22.5 cm (9")

**Olivecrona Trigeminal Knife**



Catalog #	Size
SL-493-20	20.5 cm (8")

Tonsil Knives, Razor Knives  
 Tonsillmesser, Rasiermesser  
 Bisturíes para amígdalas, Navajas  
 Bistouris pour amygdales, Rasoirs  
 Bisturi per tonsille, Rasoi

**Trigeminal Knife**



Catalog #	Size
SL-494-23	23 cm (9")

**Fowler Tonsil Knife**



Catalog #	Size
SL-501-20	20 cm (8")

**Abraham Tonsil Knife**



Catalog #	Size
SL-503-21	21 cm (8 1/4")

**Masing Cartilage Slitting Knife**



Catalog #	Size
SL-505-13	13 cm (5")

**Razor Knife**  
 Hollow Blades on Both Side

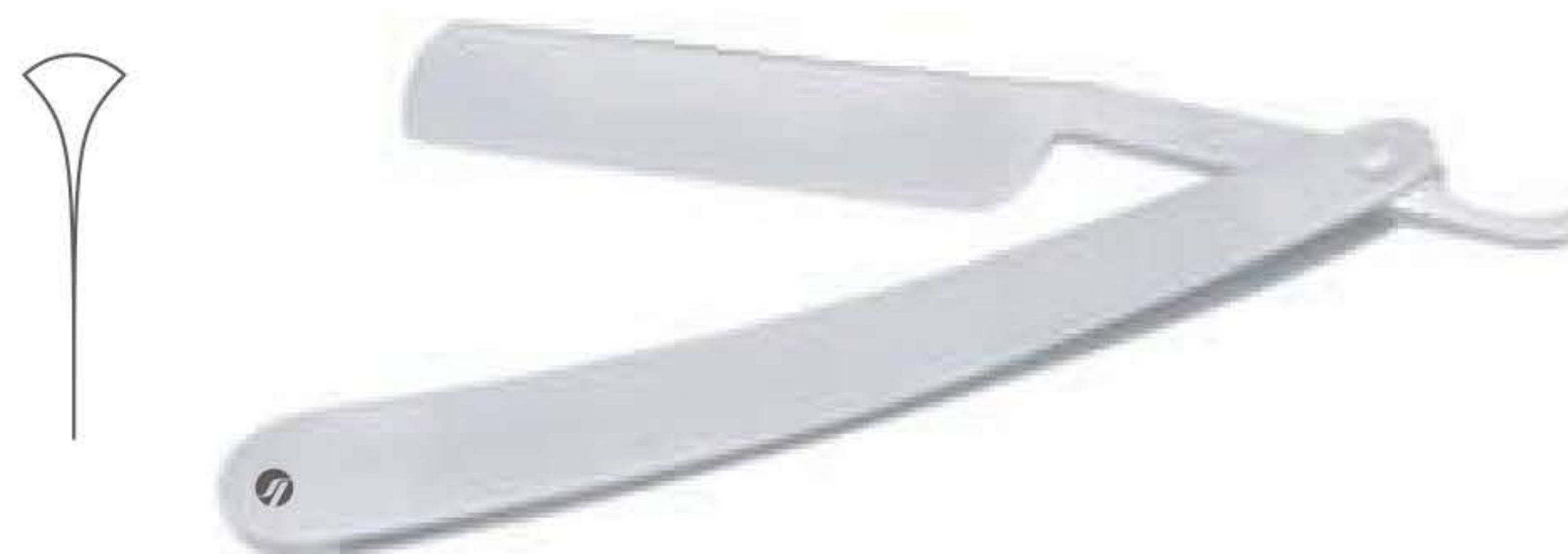

Catalog #	Size
SL-551-00	Blade Size 75 mm

Razor Knives, Dermatomes  
 Rasiermesser, Dermatome  
 Navajas, Dermátoms  
 Rasoirs, Dermatomes  
 Rasoi, Dermatomi

**Razor Knife**  
 Blade Flat/Hollow

Catalog #	Size
SL-553-00	Blade Size 80 mm



**Record-Arkansas Sharpening Stone**  
 In Wooden Case

Catalog #	Size
SL-600-00	150 x 50 mm

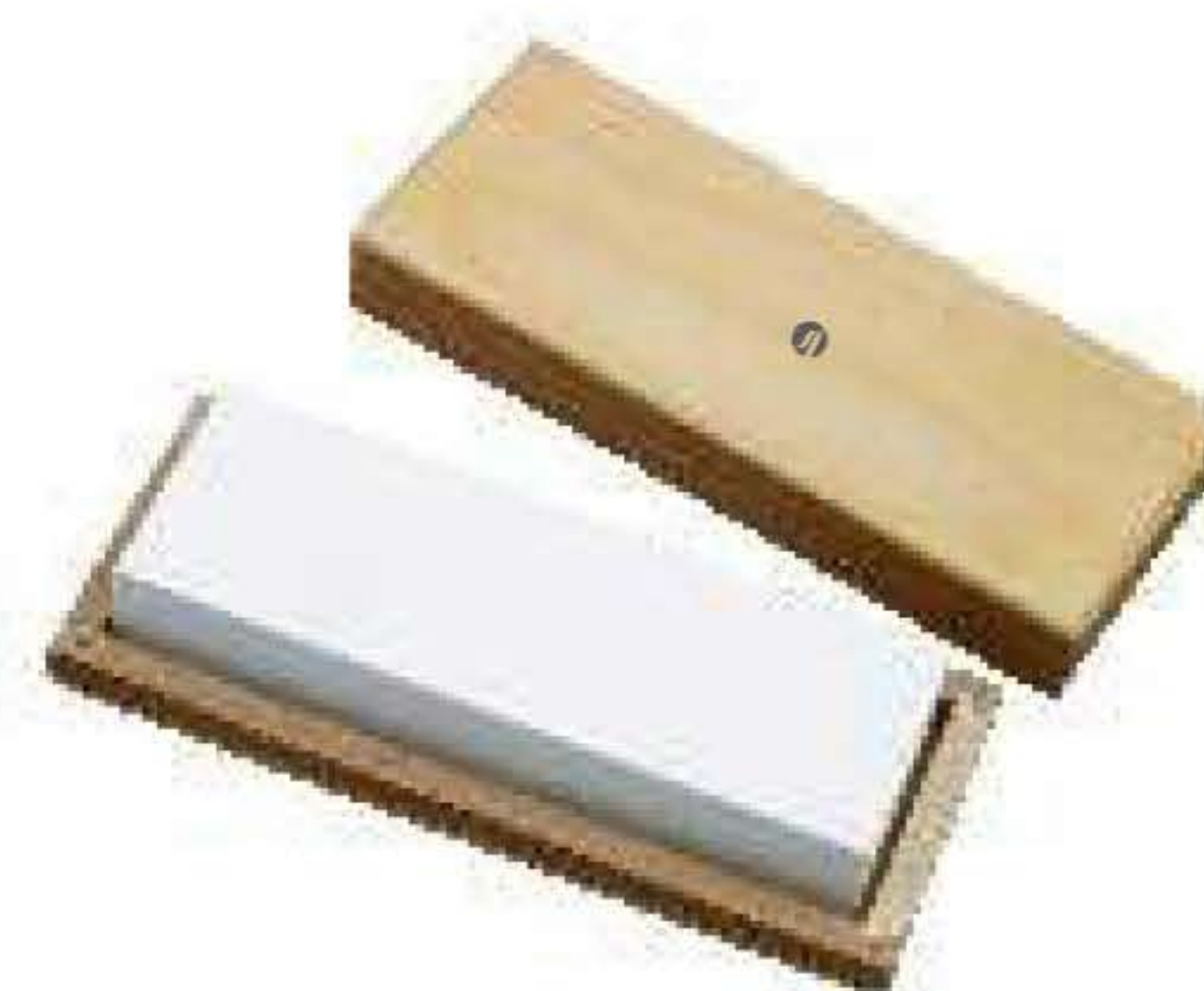

**Record-Arkansas Sharpening Stone**

Catalog #	Size
SL-602-00	Standard



**Humby Skin Graft Knife (Dermatome)**

Thickness Adjustable From 0.1 to 1.2 mm, Cutting Width Maximum 155 mm

Catalog #	Size
SL-700-32	32 cm (13")



**Watson Skin Graft Knife (Dermatome)**

Thickness Adjustable From 0.1 to 1.2 mm, Cutting Width Maximum 155 mm

Catalog #	Size
SL-710-30	30.5 cm (12")



Blade Holders / Blade Breakers, Dermatomes  
 Klingenthaler / Kingenbrecher, Dermatome  
 Porta-hojas / Rompe-hojas de afeitar, Dermátoms  
 Pincettes pour saisir et casser les lames de rasoir, Dermatomes  
 Pinze per afferrare e rompere le lamette de rasoio, Dermatomi

**Skin Graft Knife Blade (Dermatome Blade)**

For SL-700-32 and SL-710-30

Catalog #	Size
SL-712-00	15 cm (6")



**Schink Skin Graft Knife (Dermatome)**

Thickness Adjustable From 0.1 to 1.2 mm, Cutting Width Maximum 100 mm

Catalog #	Size
SL-730-31	31 cm (12 1/4")



**Schink Skin Graft Knife Blade (Dermatome Blade)**

For SL-730-31

Catalog #	Size
SL-732-00	10 cm (4")



**Skin Fixation Plate**

Catalog #	Size
SL-734-00	4 cm, 5 cm, 8 cm, 10 cm

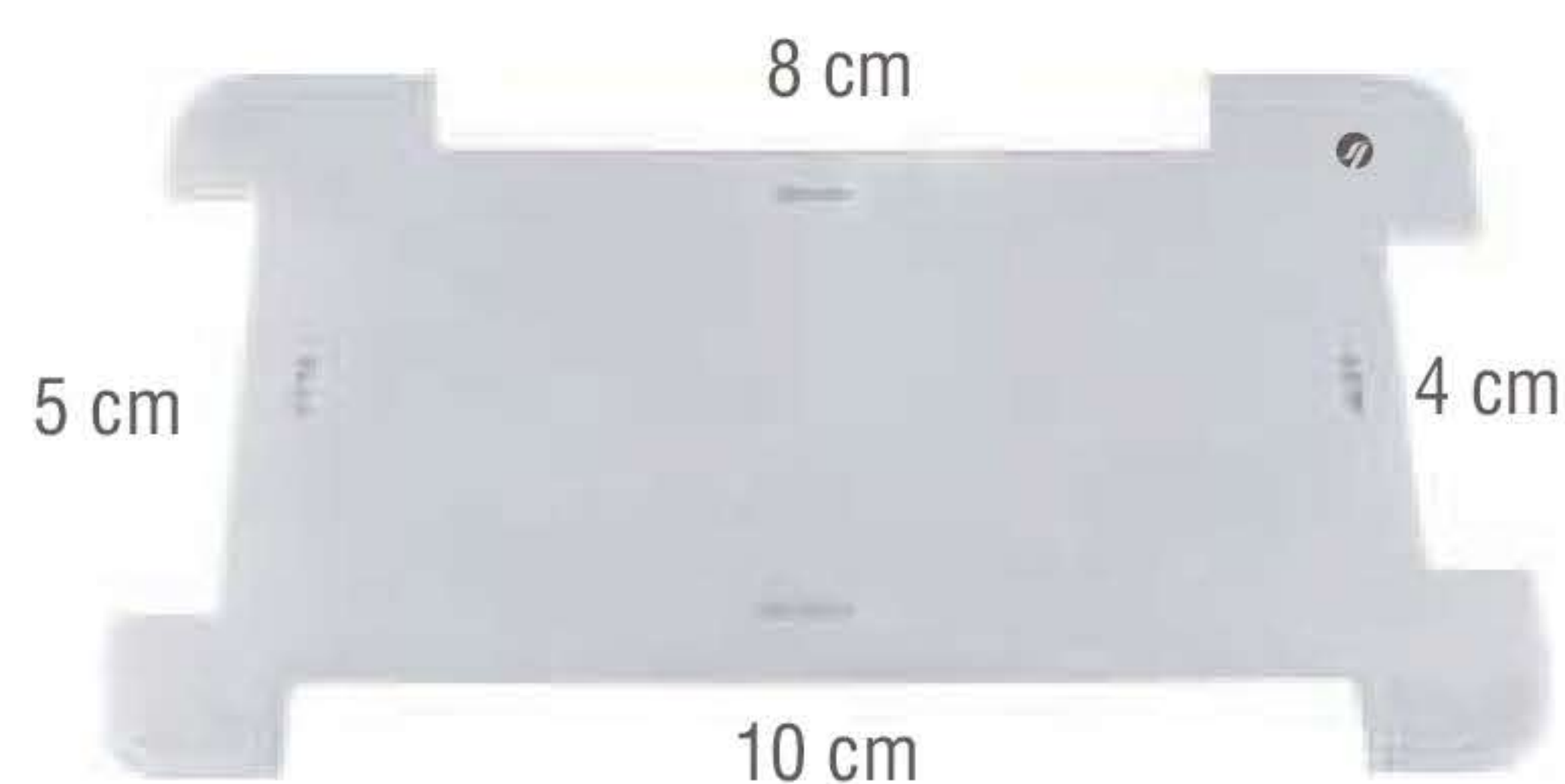

**Silver Skin Graft Knife (Dermatome)**

Thickness Adjustable From 0.1 to 1.2 mm, Cutting Width Maximum 40 mm

Catalog #	Size
SL-740-19	19 cm (7 1/2")



Dermatomes, Blade Holders / Blade Breakers  
 Dermatome, Klingenthaler / Kingenbrecher  
 Dermátoms, Porta-hojas / Rompe-hojas de afeitár  
 Dermatomes, Pincettes pour saisir et casser les lames de rasoir  
 Dermatomi, Pinze per afferrare e rompere le lamette de rasoio

### Karp Aorta Punch

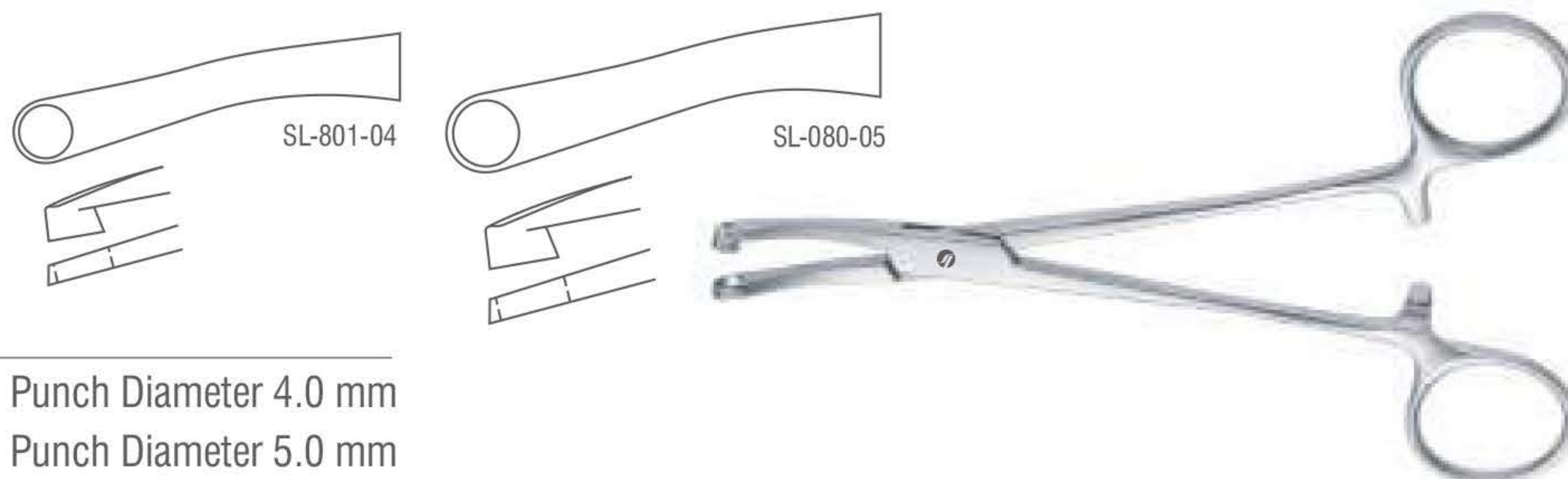

Catalog #	Size, Profile
SL-801-04	16 cm (6 1/4"), Punch Diameter 4.0 mm
SL-801-05	16 cm (6 1/4"), Punch Diameter 5.0 mm

### Troutman-Chris Blade Holder/Breaker

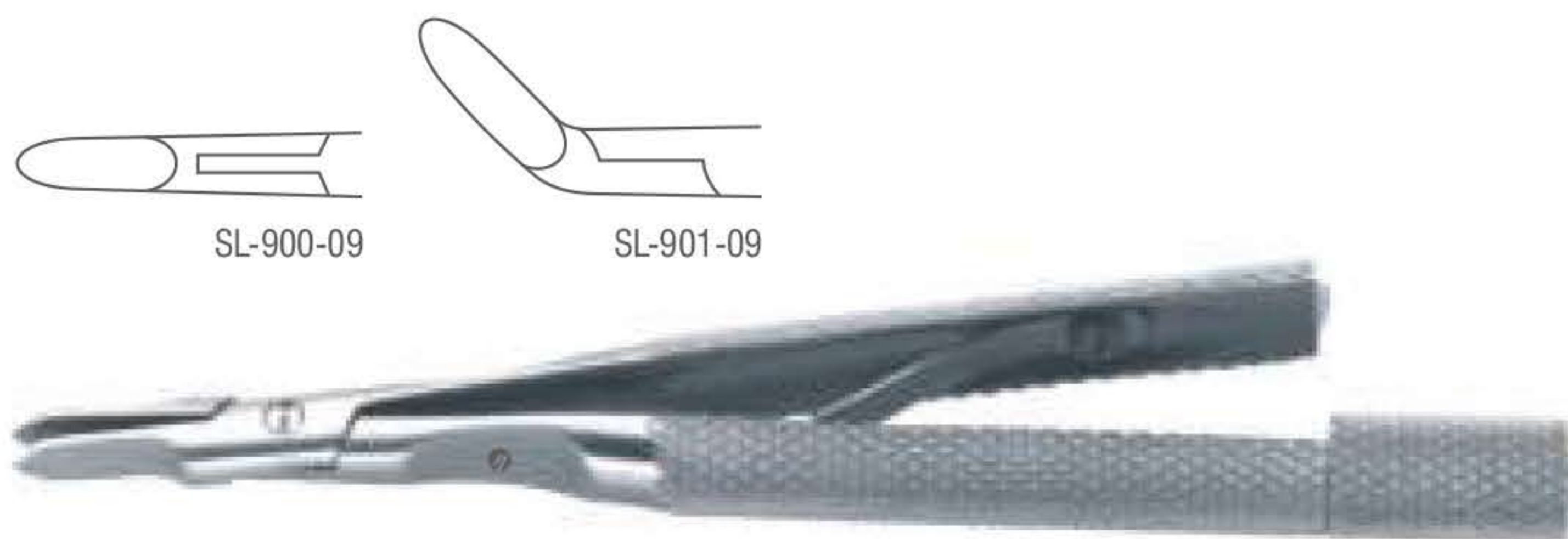

Catalog #	Size, Profile
SL-900-09	9 cm (3 1/2"), Round Handle, Straight
SL-901-09	9 cm (3 1/2"), Round Handle, Angled

### Barraquer Blade Holder/Breaker



Catalog #	Size
SL-910-11	11 cm (4 1/4")

### Castroviejo Blade Holder/Breaker Round Handle



Catalog #	Size
SL-916-13	13 cm (5")

### Silver Skin Graft Knife Blade Pack of 10

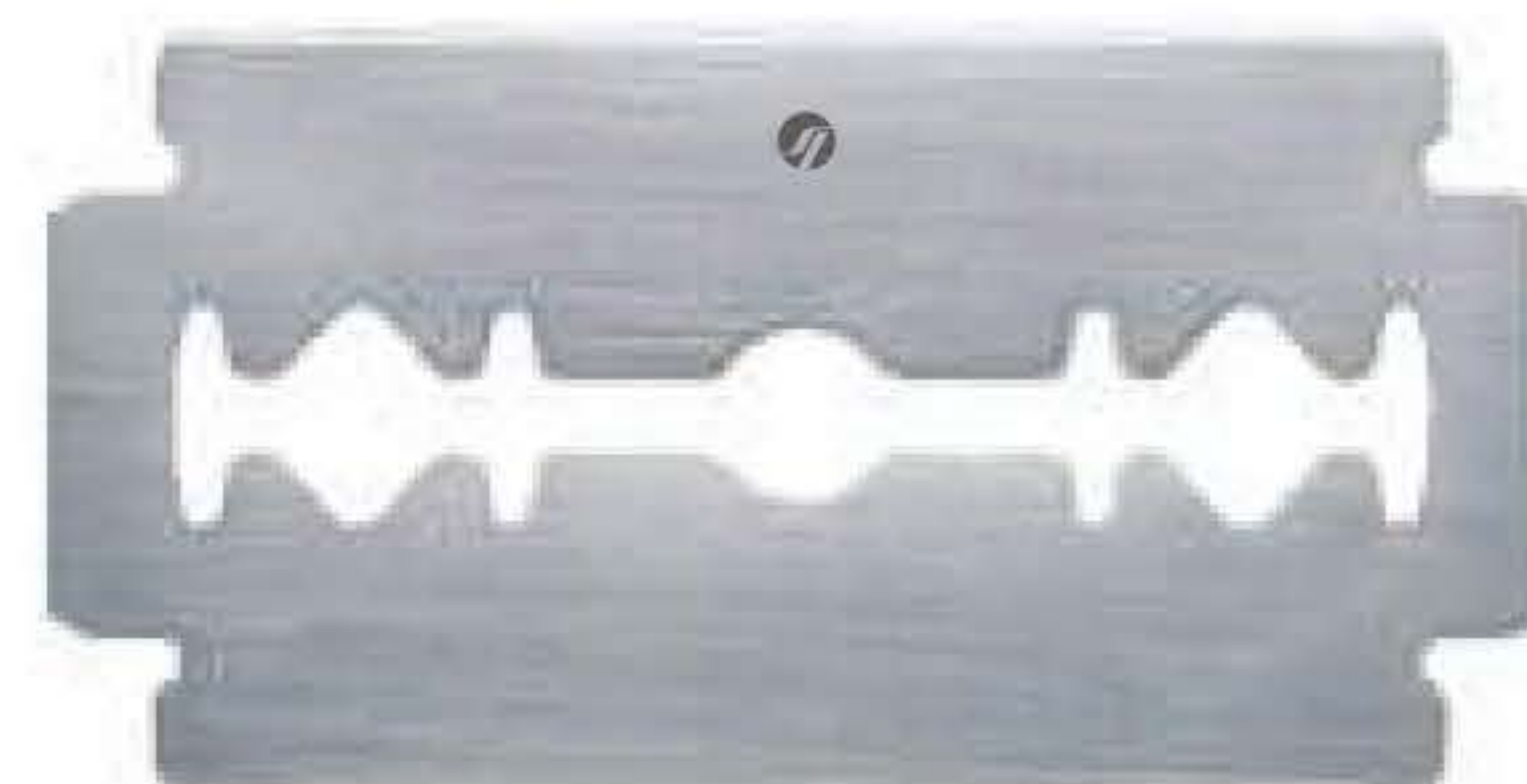

Catalog #	Size
SL-950-10	Standard

Operating Scissors  
 Chirurgische Scheren  
 Tijeras quirúrgicas  
 Ciseaux chirurgicaux  
 Forbici per chirurgia

**Operating Scissors**  
 Straight, Blunt/Blunt

Catalog #	Size
SS-002-11	12 cm (4 ¾")
SS-002-13	13 cm (5")
SS-002-14	14.5 cm (5 ¾")
SS-002-16	16.5 cm (6 ½")
SS-002-18	18.5 cm (7 ¼")
SS-002-20	20.5 cm (8")



**Operating Scissors**  
 Curved, Blunt/Blunt

Catalog #	Size
SS-003-11	12 cm (4 ¾")
SS-003-13	13 cm (5")
SS-003-14	14.5 cm (5 ¾")
SS-003-16	16.5 cm (6 ½")
SS-003-18	18.5 cm (7 ¼")
SS-003-20	20.5 cm (8")



**Operating Scissors**  
 Straight, Sharp/Blunt

Catalog #	Size
SS-004-11	12 cm (4 ¾")
SS-004-13	13 cm (5")
SS-004-14	14.5 cm (5 ¾")
SS-004-16	16.5 cm (6 ½")
SS-004-18	18.5 cm (7 ¼")
SS-004-20	20.5 cm (8")

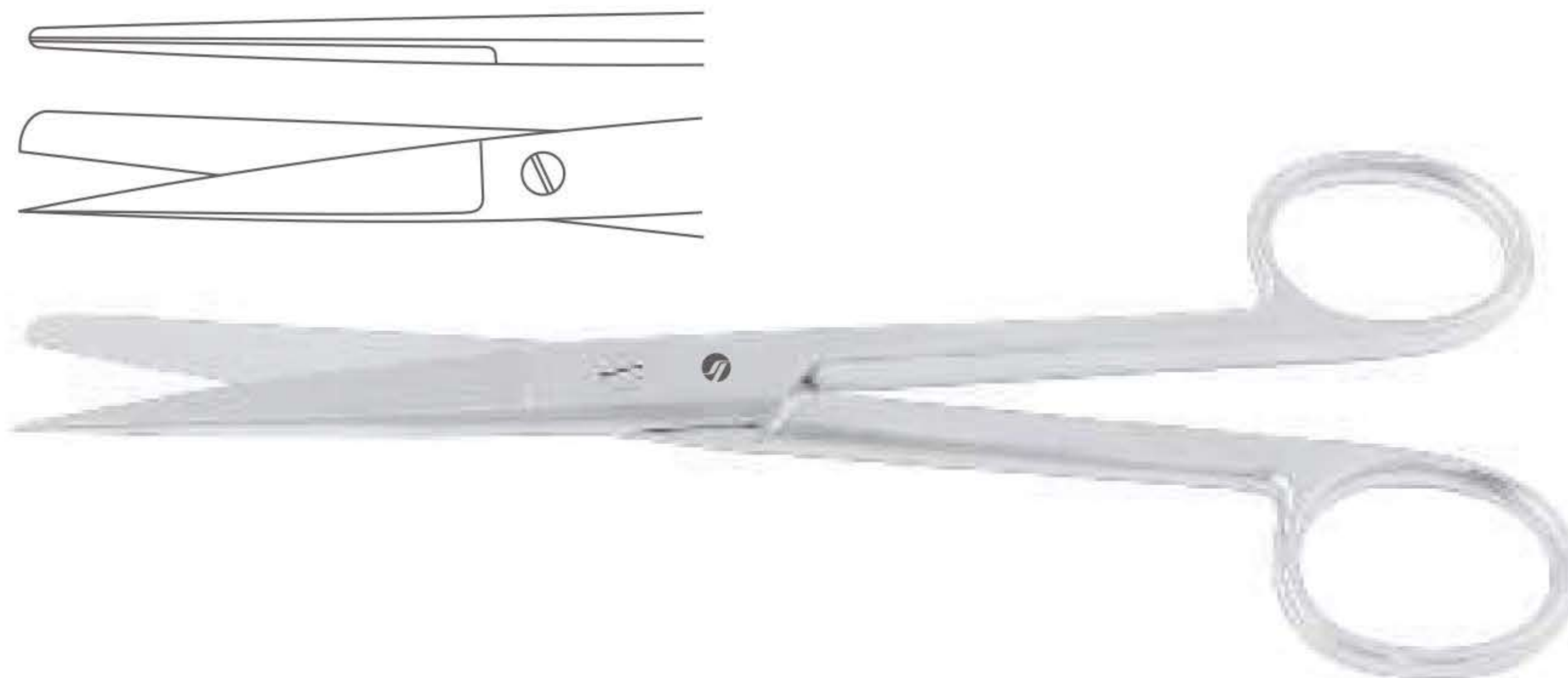

Operating Scissors  
 Chirurgische Scheren  
 Tijeras quirúrgicas  
 Ciseaux chirurgicaux  
 Forbici per chirurgia

**Operating Scissors**  
 Straight, Sharp/Blunt

**SUPER Edge™**

Catalog #	Size
SS-004-13 SC	13 cm (5")
SS-004-14 SC	14.5 cm (5 3/4")



**Operating Scissors**  
 Curved, Sharp/Blunt

Catalog #	Size
SS-005-11	12 cm (4 3/4")
SS-005-13	13 cm (5")
SS-005-14	14.5 cm (5 3/4")
SS-005-16	16.5 cm (6 1/2")
SS-005-18	18.5 cm (7 1/4")
SS-005-20	20.5 cm (8")



**Operating Scissors**  
 Curved, Sharp/Blunt,

**SUPER Edge™**

Catalog #	Size
SS-005-13 SC	13 cm (5")
SS-005-14 SC	14.5 cm (5 3/4")



**Operating Scissors**  
 Straight, Sharp/Sharp

Catalog #	Size
SS-006-11	12 cm (4 3/4")
SS-006-13	13 cm (5")
SS-006-14	14.5 cm (5 3/4")
SS-006-16	16.5 cm (6 1/2")
SS-006-18	18.5 cm (7 1/4")
SS-006-20	20.5 cm (8")



Operating Scissors  
 Chirurgische Scheren  
 Tijeras quirúrgicas  
 Ciseaux chirurgicaux  
 Forbici per chirurgia

**Operating Scissors**  
 Curved, Sharp/Sharp

Catalog #	Size
SS-007-11	12 cm (4 3/4")
SS-007-13	13 cm (5")
SS-007-14	14.5 cm (5 3/4")
SS-007-16	16.5 cm (6 1/2")
SS-007-18	18.5 cm (7 1/4")
SS-007-20	20.5 cm (8")

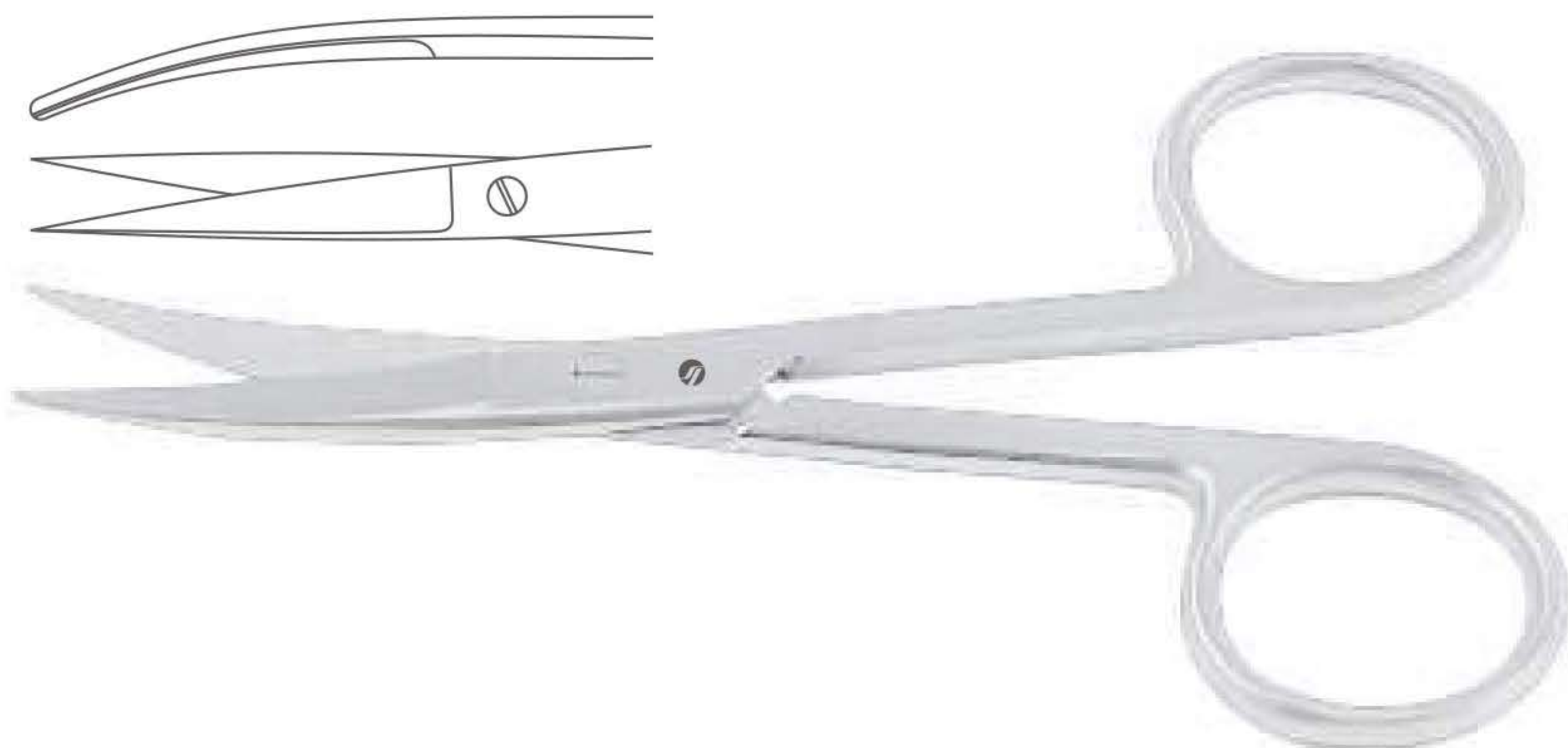

**Operating Scissors**  
 Straight, Blunt/Blunt

Catalog #	Size
SS-010-14	14.5 cm (5 3/4")



**Operating Scissors**  
 Curved, Blunt/Blunt

Catalog #	Size
SS-011-14	14.5 cm (5 3/4")

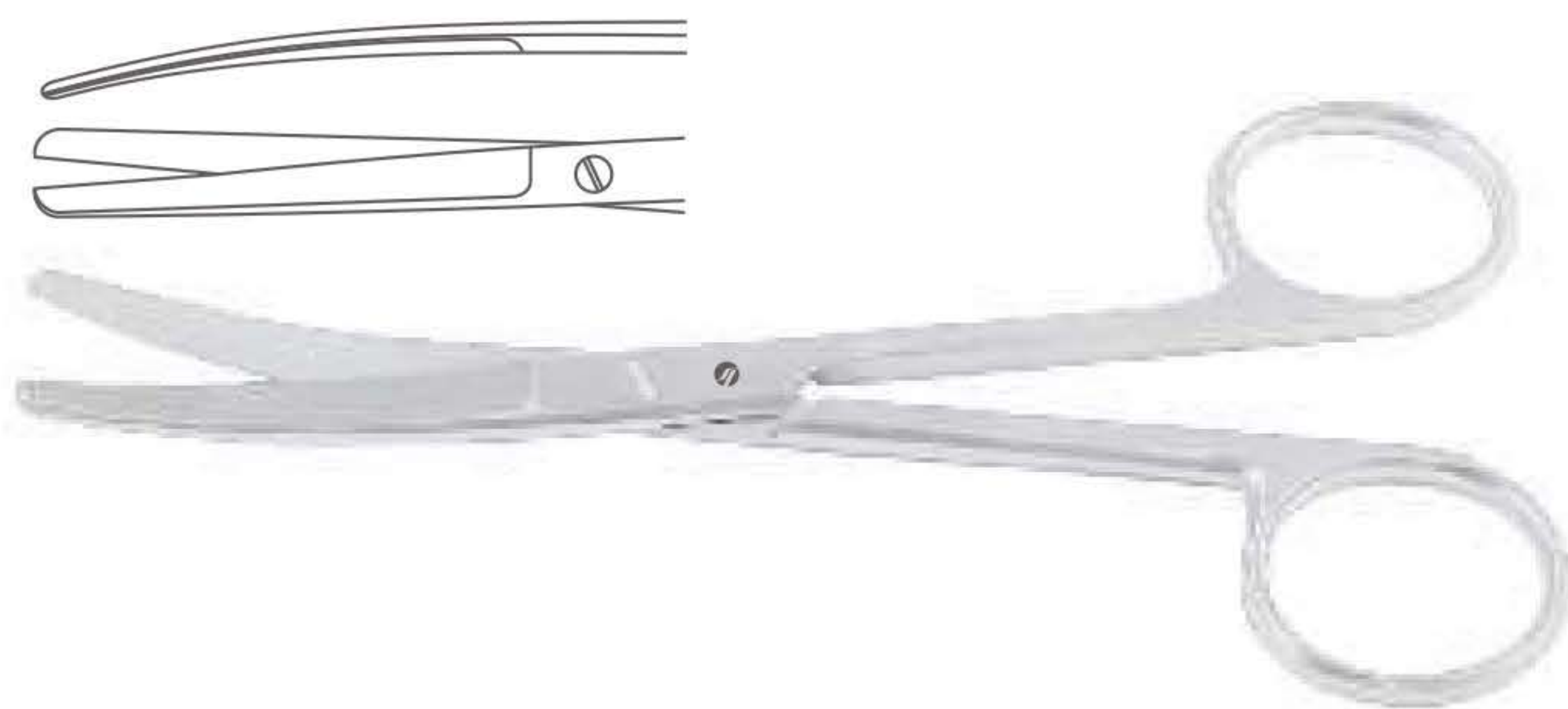

**Operating Scissors**  
 Straight, Sharp/Blunt

Catalog #	Size
SS-012-14	14.5 cm (5 3/4")

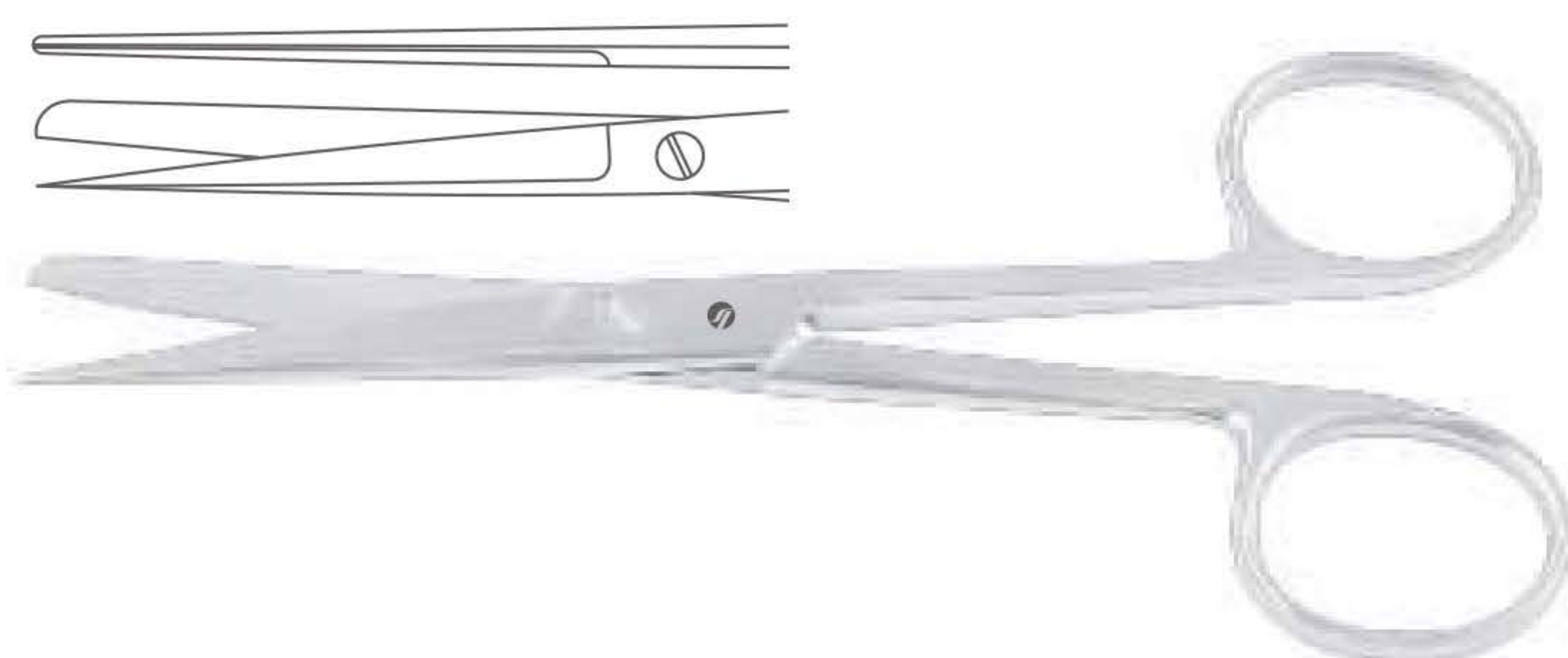

Operating Scissors  
 Chirurgische Scheren  
 Tijeras quirúrgicas  
 Ciseaux chirurgicaux  
 Forbici per chirurgia

**Operating Scissors**  
 Curved, Sharp/Blunt

Catalog #	Size
SS-013-14	14.5 cm (5 ¾")



**Operating Scissors**  
 Straight, Sharp/Sharp

Catalog #	Size
SS-014-14	14.5 cm (5 ¾")



**Operating Scissors**  
 Curved, Sharp/Sharp

Catalog #	Size
SS-015-14	14.5 cm (5 ¾")

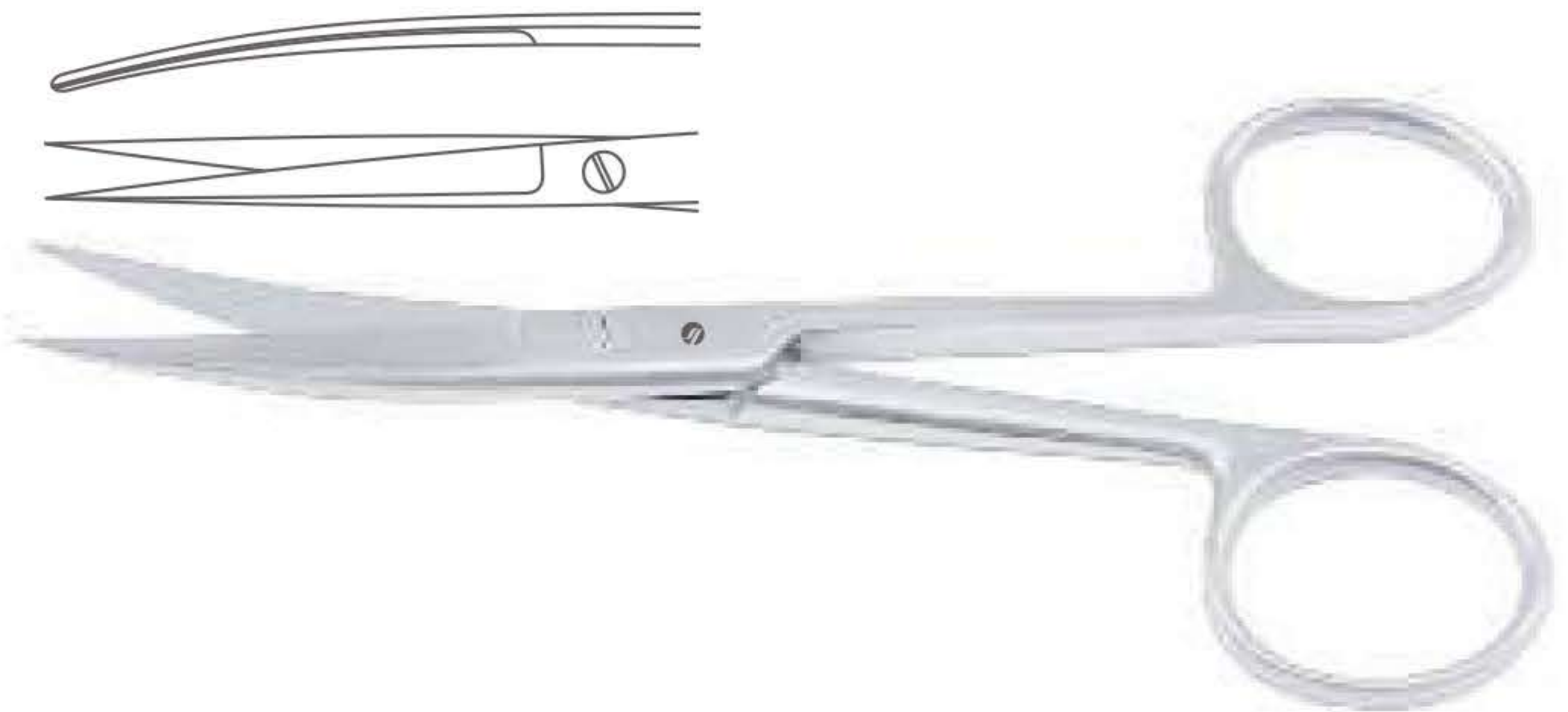

**Incision Scissor**  
 Straight

Catalog #	Size
SS-018-13	13 cm (5")
SS-020-14	14.5 cm (5 ¾")
SS-022-16	16.5 cm (6 ½")



**Systrunk Nail Splitting Scissor**  
 Straight

Catalog #	Size
SS-024-13	13 cm (5")



Operating Scissors, Dissecting Scissors  
 Chirurgische Scheren, Präparierscheren  
 Tijeras quirúrgicas, Tijeras de disección  
 Ciseaux chirurgicaux, Ciseaux à dissection  
 Forbici per chirurgia, Forbici per dissezione

**Deaver Operating Scissor**  
 Straight, Sharp/Blunt

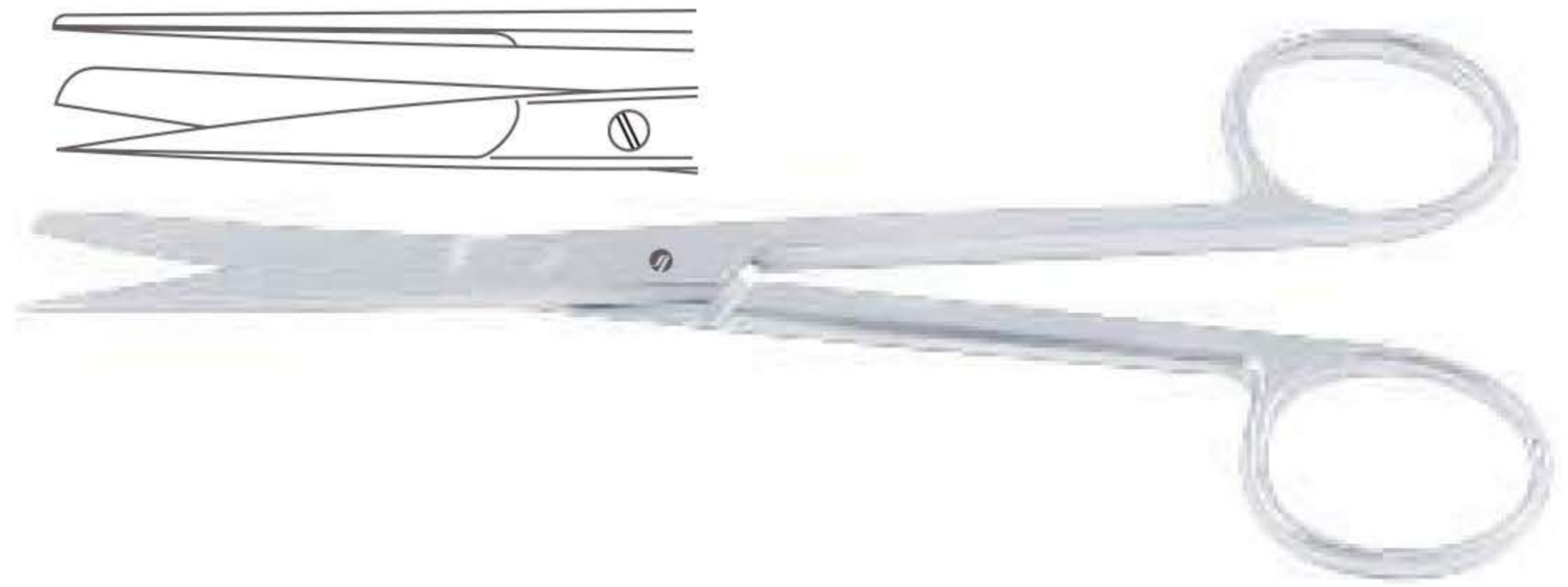

Catalog #	Size
SS-030-14	14 cm (5 1/2")

**Deaver Operating Scissor**  
 Curved, Sharp/Blunt



Catalog #	Size
SS-031-14	14 cm (5 1/2")

**Mayo Dissecting Scissor**  
 Straight



Catalog #	Size
SS-040-14	14.5 cm (5 3/4")
SS-040-15	15 cm (6")
SS-040-17	17 cm (6 3/4")
SS-040-23	23.5 cm (9 1/4")

**Mayo Dissecting Scissor**  
 Straight

**SUPER Edge™**

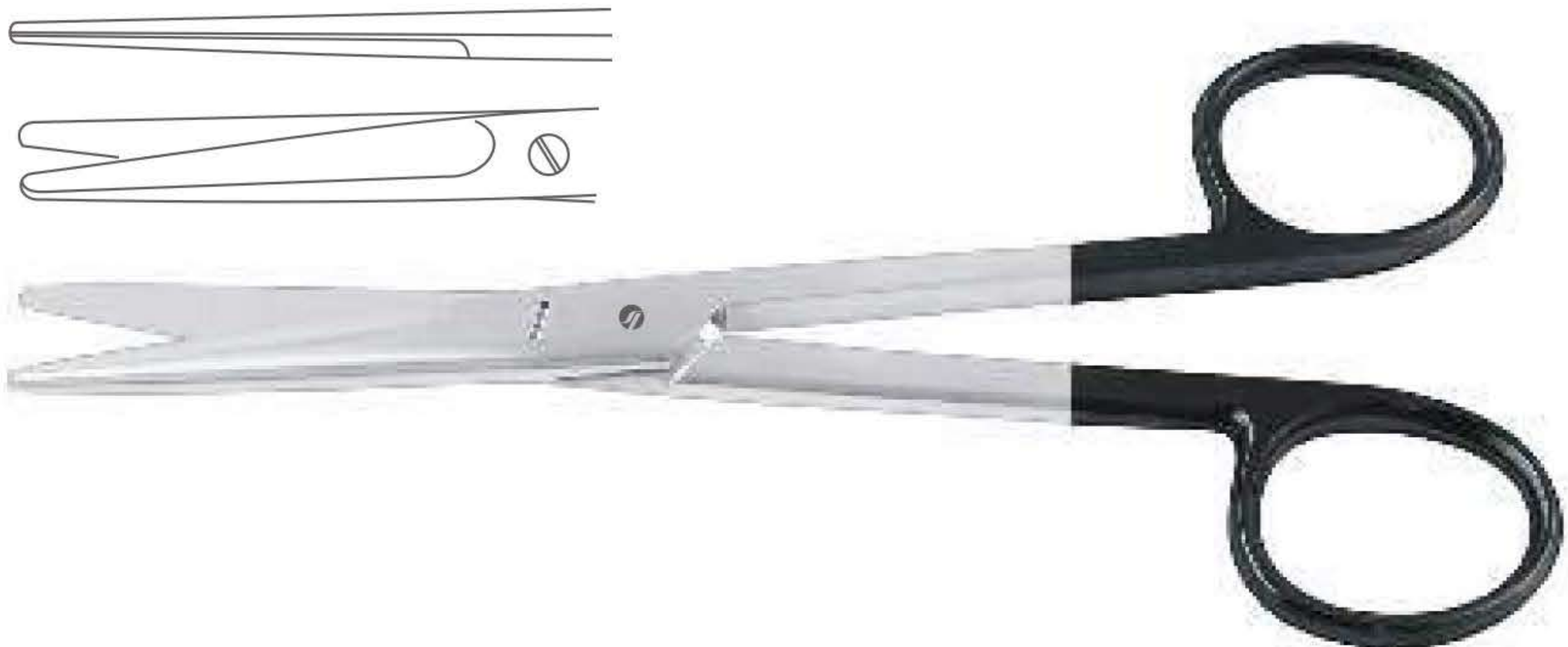

Catalog #	Size
SS-040-14 SC	14.5 cm (5 3/4")
SS-040-15 SC	15 cm (6")
SS-040-17 SC	17 cm (6 3/4")

Dissecting Scissors  
 Präparierscheren  
 Tijeras de disección  
 Ciseaux à dissection  
 Forbici per dissezione

**Mayo Dissecting Scissor**  
 Curved

Catalog #	Size
SS-041-14	14.5 cm (5 ¾")
SS-041-15	15 cm (6")
SS-041-17	17 cm (6 ¾")
SS-041-23	23.5 cm (9 ¼")



**Mayo Dissecting Scissor**  
 Curved

**SUPER Edge™**

Catalog #	Size
SS-041-14 SC	14.5 cm (5 ¾")
SS-041-15 SC	15 cm (6")
SS-041-17 SC	17 cm (6 ¾")



**Mayo Dissecting Scissor**  
 Straight, With Chamfered Blades

Catalog #	Size
SS-042-19	19 cm (7 ½")
SS-042-21	21.5 cm (8 ½")



**Mayo Dissecting Scissor**  
 Curved, With Chamfered Blades

Catalog #	Size
SS-043-19	19 cm (7 ½")
SS-043-21	21.5 cm (8 ½")



Dissecting Scissors  
 Präparierscheren  
 Tijeras de disección  
 Ciseaux à dissection  
 Forbici per dissezione

**Mayo-Harrington Dissecting Scissor**  
 Straight

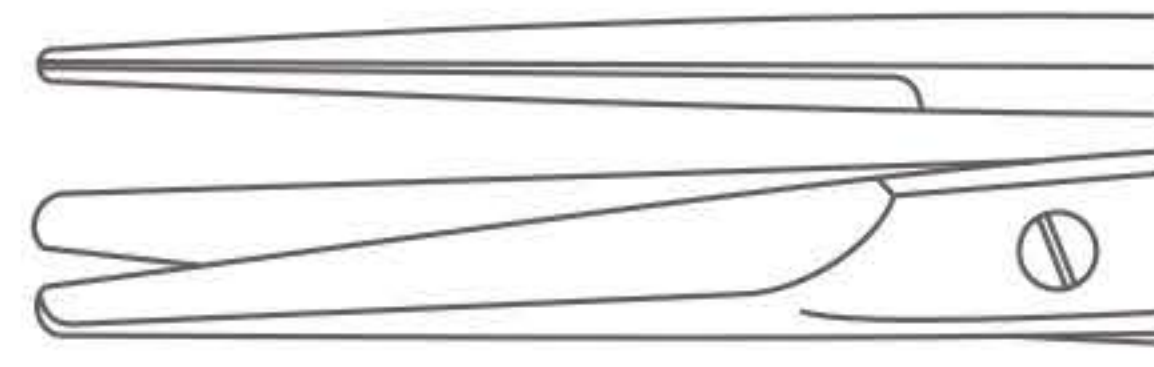

Catalog #	Size
SS-046-23	23 cm (9")

**Mayo-Harrington Dissecting Scissor**  
 Straight

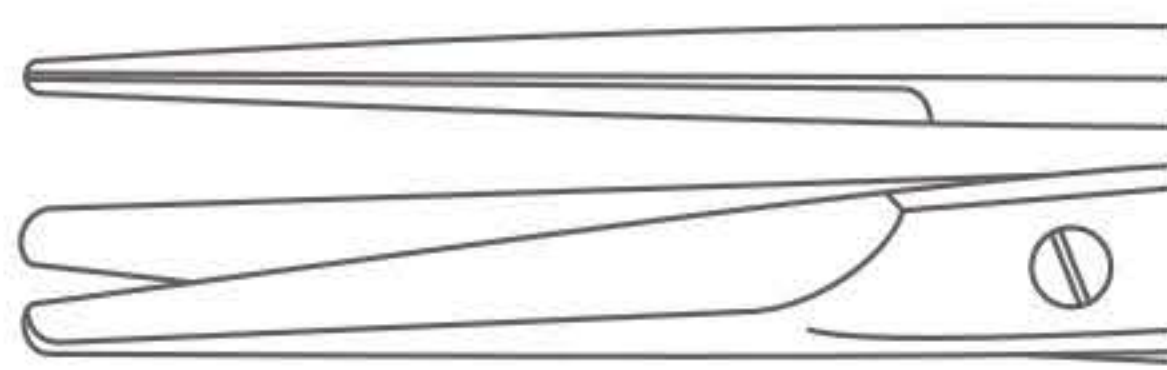

**SUPER Edge™**

Catalog #	Size
SS-046-23 SC	23 cm (9")

**Mayo-Harrington Dissecting Scissor**  
 Curved

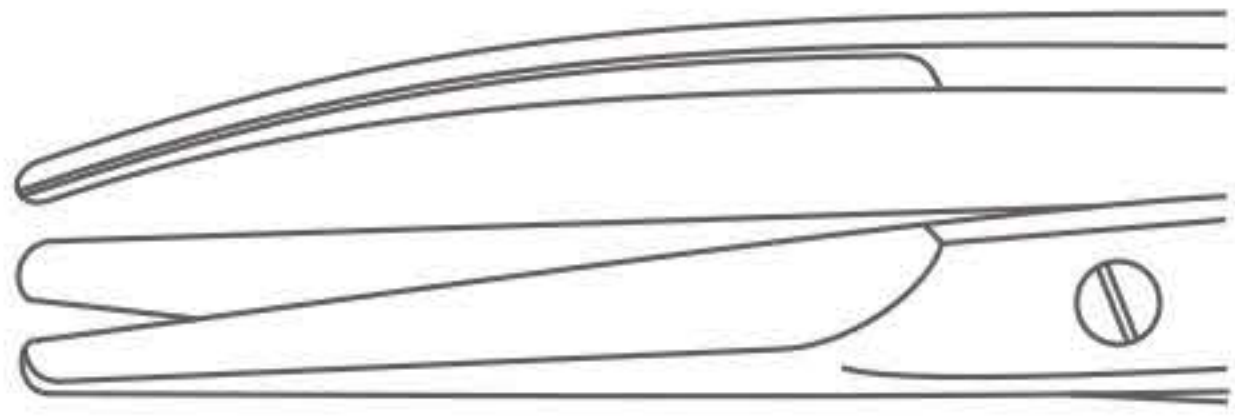

Catalog #	Size
SS-047-23	22.5 cm (9")
SS-047-28	28 cm (11")

**Mayo-Harrington Dissecting Scissor**  
 Curved

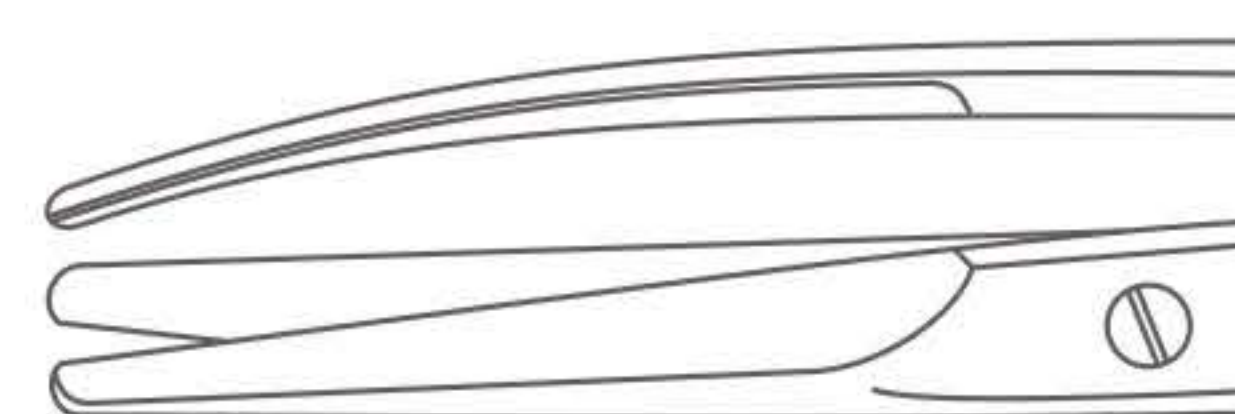

**SUPER Edge™**

Catalog #	Size
SS-047-23 SC	22.5 cm (9")

Dissecting Scissors  
 Präparierscheren  
 Tijeras de disección  
 Ciseaux à dissection  
 Forbici per dissezione

**Mayo-Stille Dissecting Scissor**  
 Straight

Catalog #	Size
SS-050-15	15 cm (6")
SS-050-17	17 cm (6 ¾")
SS-050-19	19.5 cm (7 ¾")
SS-050-21	21.5 cm (8 ½")



**Mayo-Stille Dissecting Scissor**  
 Straight

**SUPER Edge™**

Catalog #	Size
SS-050-15 SC	15 cm (6")
SS-050-17 SC	17 cm (6 ¾")



**Mayo-Stille Dissecting Scissor**  
 Curved

Catalog #	Size
SS-051-15	15 cm (6")
SS-051-17	17 cm (6 ¾")
SS-051-19	19.5 cm (7 ¾")
SS-051-21	21.5 cm (8 ½")



**Mayo-Stille Dissecting Scissor**  
 Curved

**SUPER Edge™**

Catalog #	Size
SS-051-15 SC	15 cm (6")
SS-051-17 SC	17 cm (6 ¾")



Dissecting Scissors, Gynecological Scissors  
 Präparierscheren, Gynäkologische Scheren  
 Tijeras de disección, Tijeras para ginecología  
 Ciseaux à dissection, Ciseaux à gynécologie  
 Forbici per dissezione, Forbici per ginecologia

**Mayo-Stille Dissecting Scissor**  
 Straight, With Chamfered Blades

Catalog #	Size
SS-052-14	14 cm (5 1/2")
SS-052-17	17 cm (6 3/4")

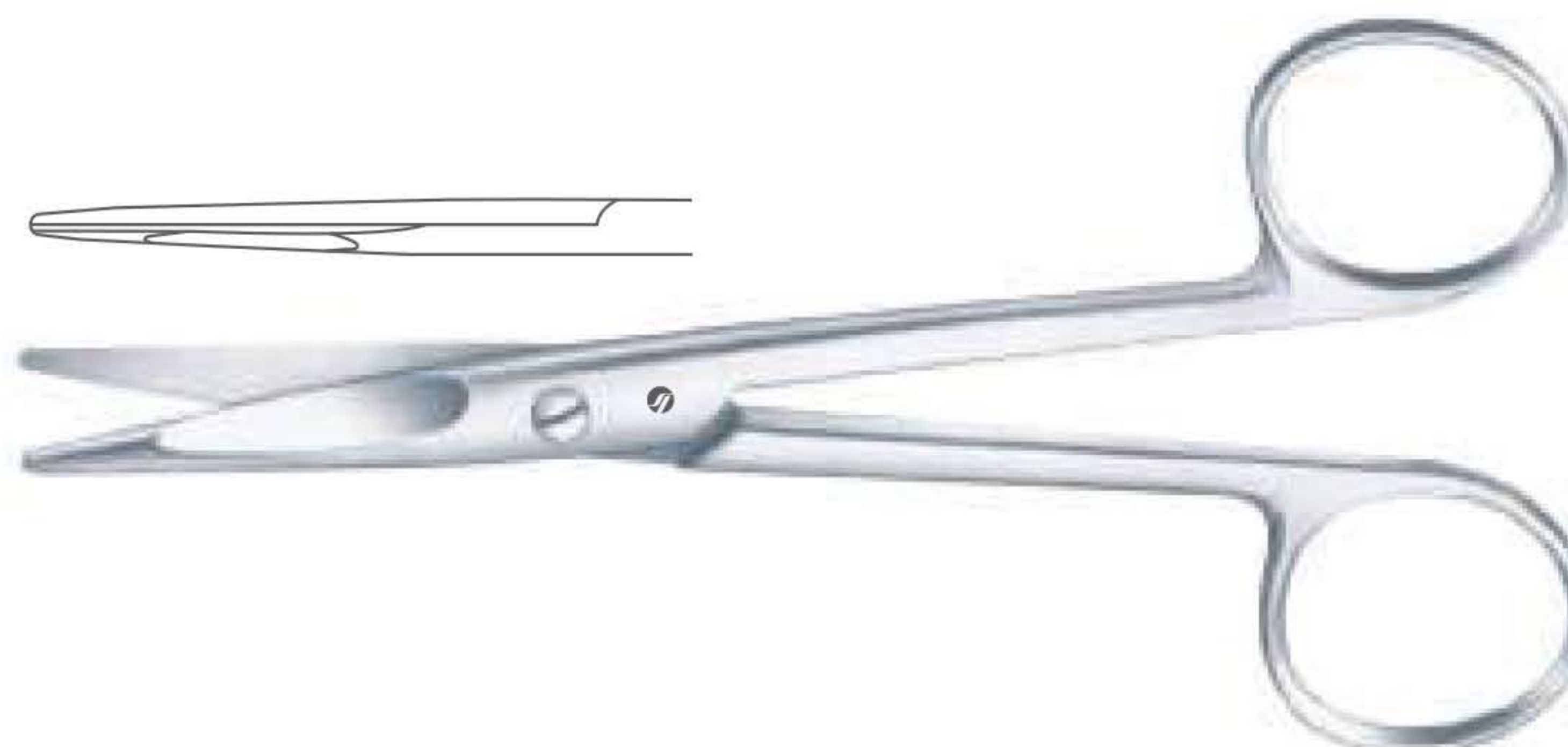

**Mayo-Stille Dissecting Scissor**  
 Curved, With Chamfered Blades

Catalog #	Size
SS-053-14	14 cm (5 1/2")
SS-053-17	17 cm (6 3/4")



**Stille Dissecting Scissor**  
 Straight

Catalog #	Size
SS-056-15	15 cm (6")



**Stille Dissecting Scissor**  
 Curved

Catalog #	Size
SS-057-15	15 cm (6")



**Mayo-Noble Gynecological Scissor**  
 Straight

Catalog #	Size
SS-060-17	16.5 cm (6 1/2")



Gynecological Scissors  
 Gynäkologische Scheren  
 Tijeras para ginecología  
 Ciseaux à gynécologie  
 Forbici per ginecologia

**Mayo-Noble Gynecological Scissor**  
 Curved

Catalog #	Size
SS-061-17	16.5 cm (6 1/2")



**Sims Gynecological Scissor**  
 Straight

Catalog #	Size
SS-070-20	20 cm (8")
SS-070-23	23 cm (9")



**Sims Gynecological Scissor**  
 Straight

**SUPER** *Edge*™

Catalog #	Size
SS-070-20 SC	20 cm (8")
SS-070-23 SC	23 cm (9")



**Sims Gynecological Scissor**  
 Curved

Catalog #	Size
SS-071-20	20 cm (8")
SS-071-23	23 cm (9")



Gynecological Scissors  
 Gynäkologische Scheren  
 Tijeras para ginecología  
 Ciseaux à gynécologie  
 Forbici per ginecologia

**Sims Gynecological Scissor**  
 Curved

**SUPER Edge™**

Catalog #	Size
SS-071-20 SC	20 cm (8")
SS-071-23 SC	23 cm (9")



**Doyen Gynecological Scissor**  
 Straight

Catalog #	Size
SS-074-17	18.5 cm (7 1/4")



**Doyen Gynecological Scissor**  
 Curved

Catalog #	Size
SS-075-17	18.5 cm (7 1/4")



**Sims-Siebold Gynecological Scissor**  
 Straight

Catalog #	Size
SS-078-24	24.5 cm (9 3/4")



**Sims-Siebold Gynecological Scissor**  
 Straight

**SUPER Edge™**

Catalog #	Size
SS-078-24 SC	24.5 cm (9 3/4")



Gynecological Scissors  
 Gynäkologische Scheren  
 Tijeras para ginecología  
 Ciseaux à gynécologie  
 Forbici per ginecologia

**Sims-Siebold Gynecological Scissor**  
 Curved

Catalog #	Size
SS-079-24	24.5 cm (9 3/4")

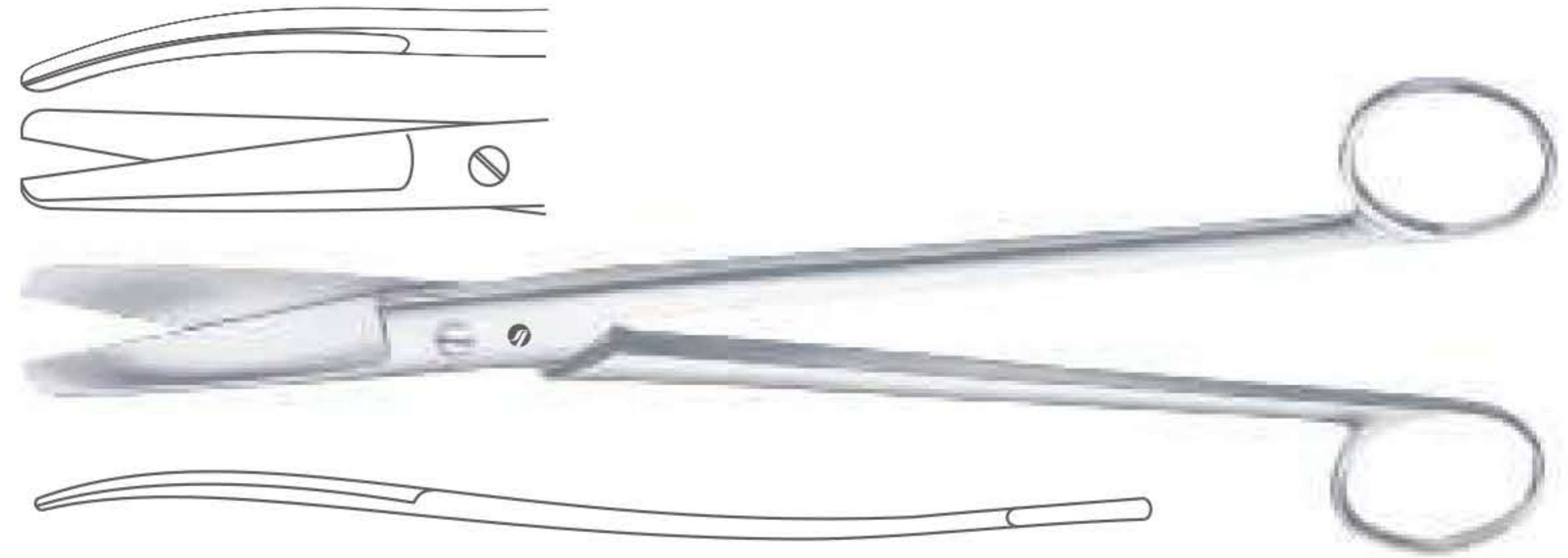

**Sims-Siebold Gynecological Scissor**  
 Curved

**SUPER Edge™**

Catalog #	Size
SS-079-24 SC	24.5 cm (9 3/4")

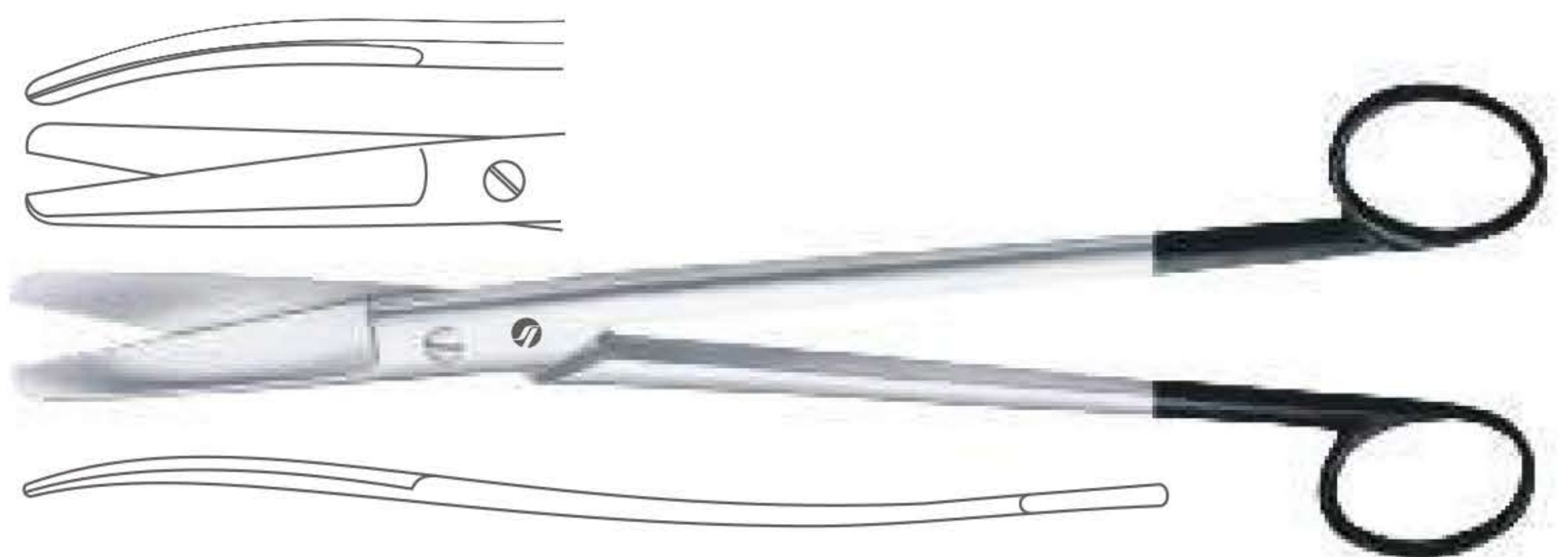

**Sims Gynecological Scissor**  
 Straight, Sharp/Sharp

Catalog #	Size
SS-082-20	20 cm (8")

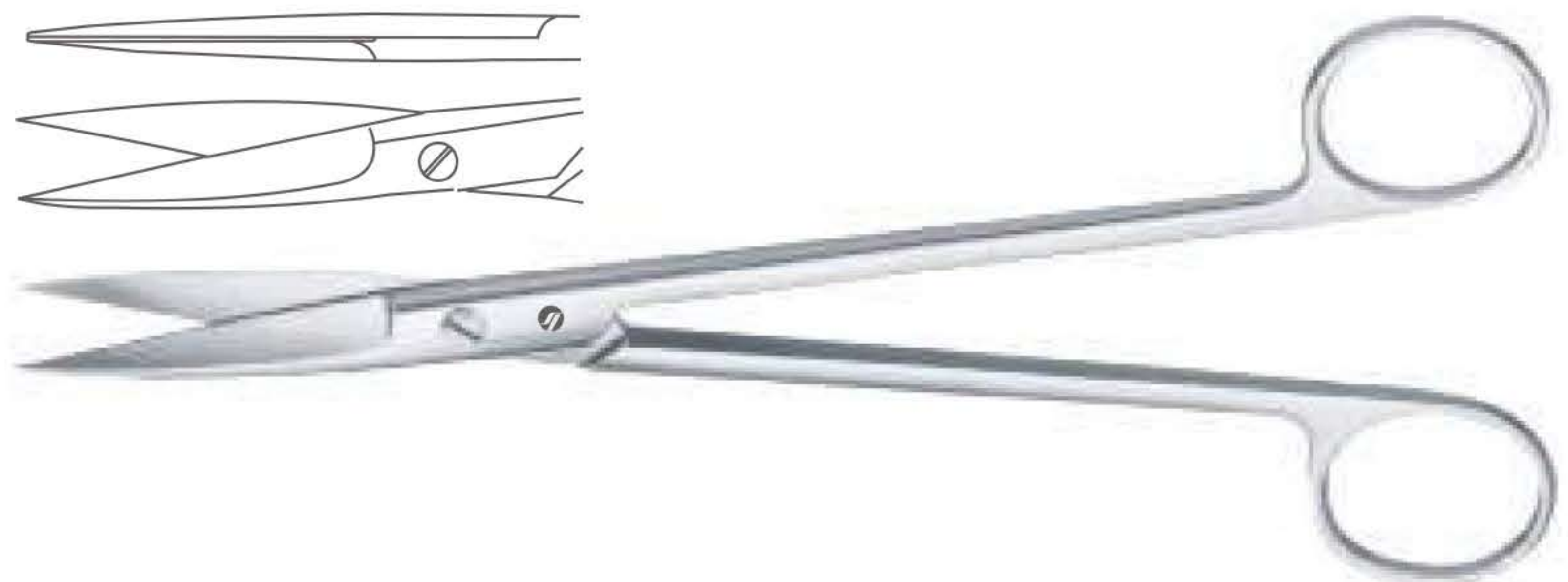

**Sims Gynecological Scissor**  
 Curved, Blunt/Blunt

Catalog #	Size
SS-085-21	21 cm (8 1/4")

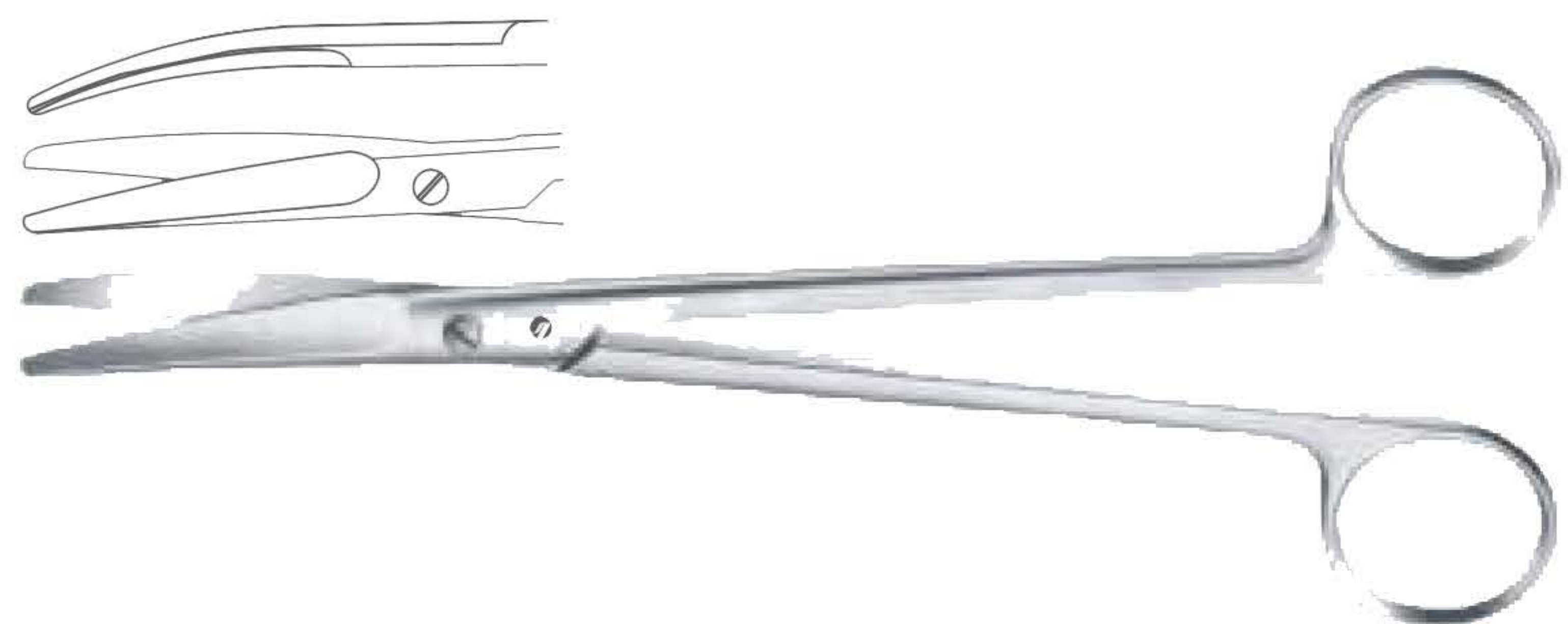

**Wertheim Gynecological Scissor**  
 Curved

Catalog #	Size
SS-087-20	20 cm (8")
SS-087-23	23 cm (9")



Gynecological Scissors, Dissecting Scissors  
 Gynäkologische Scheren, Präparierscheren  
 Tijeras para ginecología, Tijeras de disección  
 Ciseaux à gynécologie, Ciseaux à dissection  
 Forbici per ginecologia, Forbici per dissezione

**Bozemann Gynecological Scissor**  
 S Shaped

Catalog #	Size
SS-089-22	22 cm (8 3/4")



**Kieback Parametrium Scissor**  
 Angled 90°

Catalog #	Size
SS-091-24	24 cm (9 1/2")
SS-091-35	35 cm (13 3/4")



**Kieback Parametrium Scissor**  
 Curved to Side, One Probe Pointed Blade  
 One Toothed Cutting Edge

Catalog #	Size
SS-093-26	26 cm (10 1/4")
SS-093-35	35 cm (13 3/4")

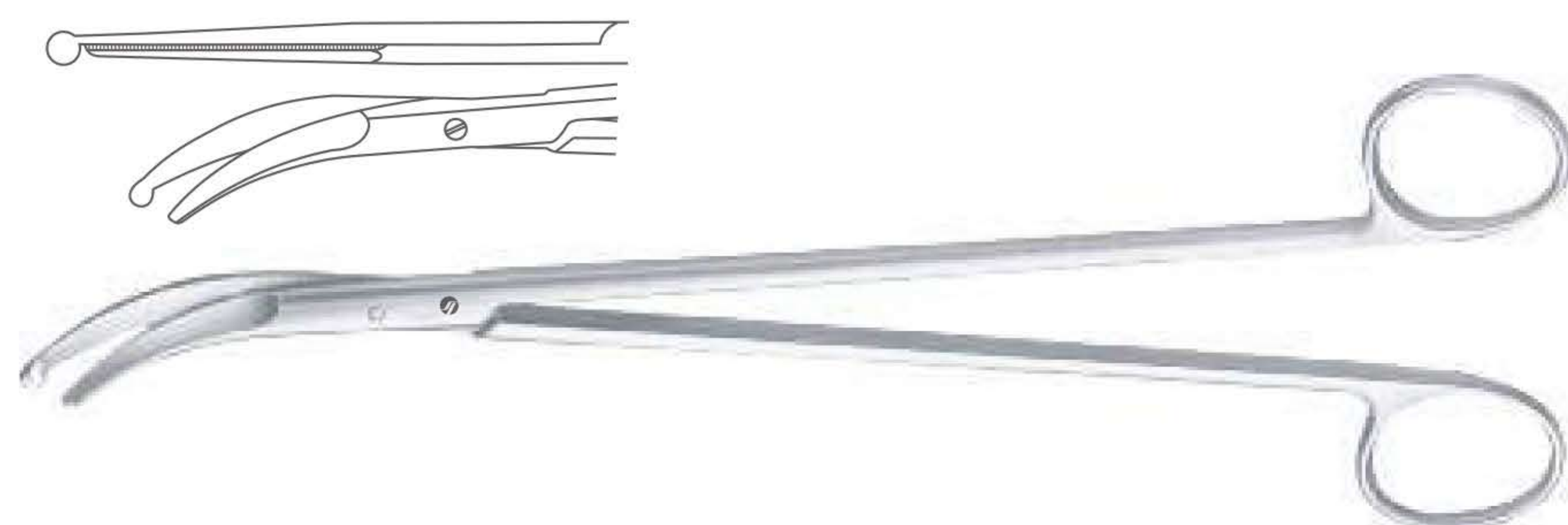

**Kelly Dissecting Scissor**  
 Straight

Catalog #	Size
SS-100-16	16 cm (6 1/4")

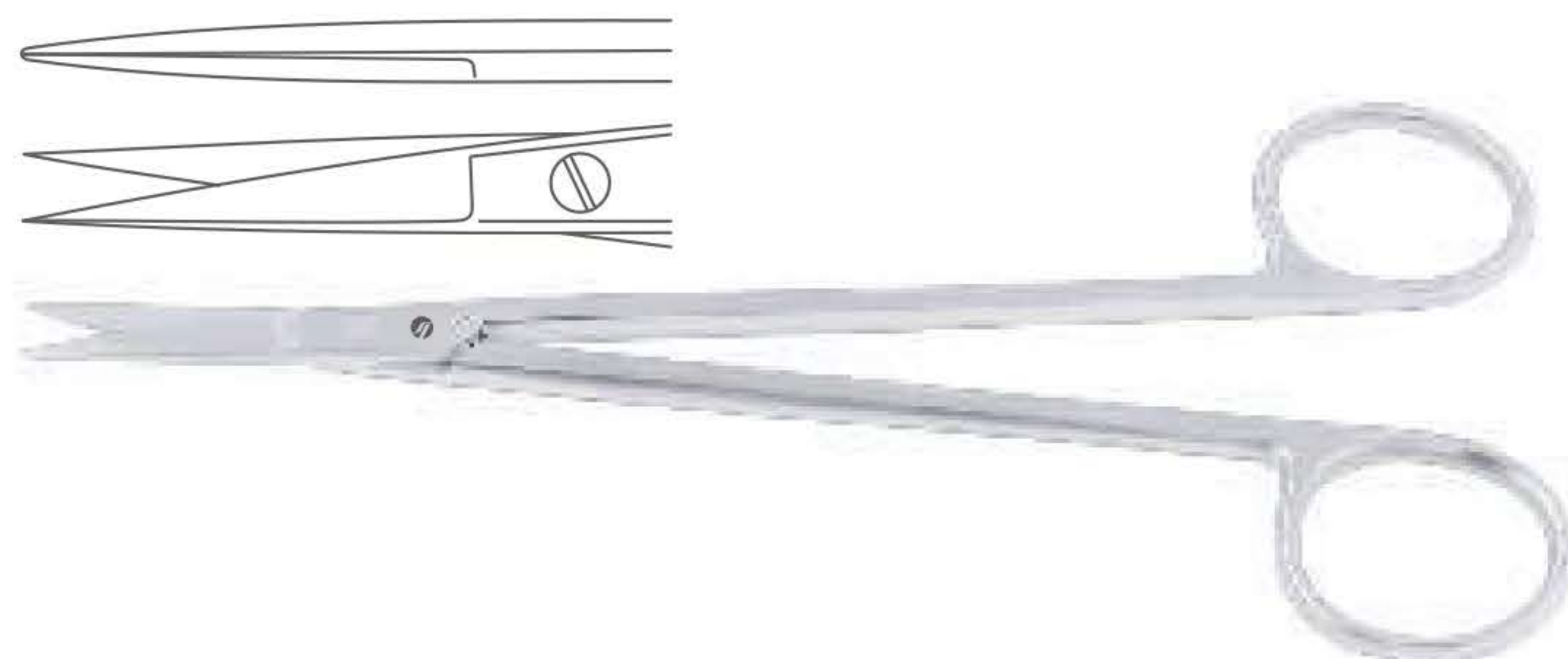

**Kelly Dissecting Scissor**  
 Straight

**SUPER** Edge™

Catalog #	Size
SS-100-16 SC	16 cm (6 1/4")

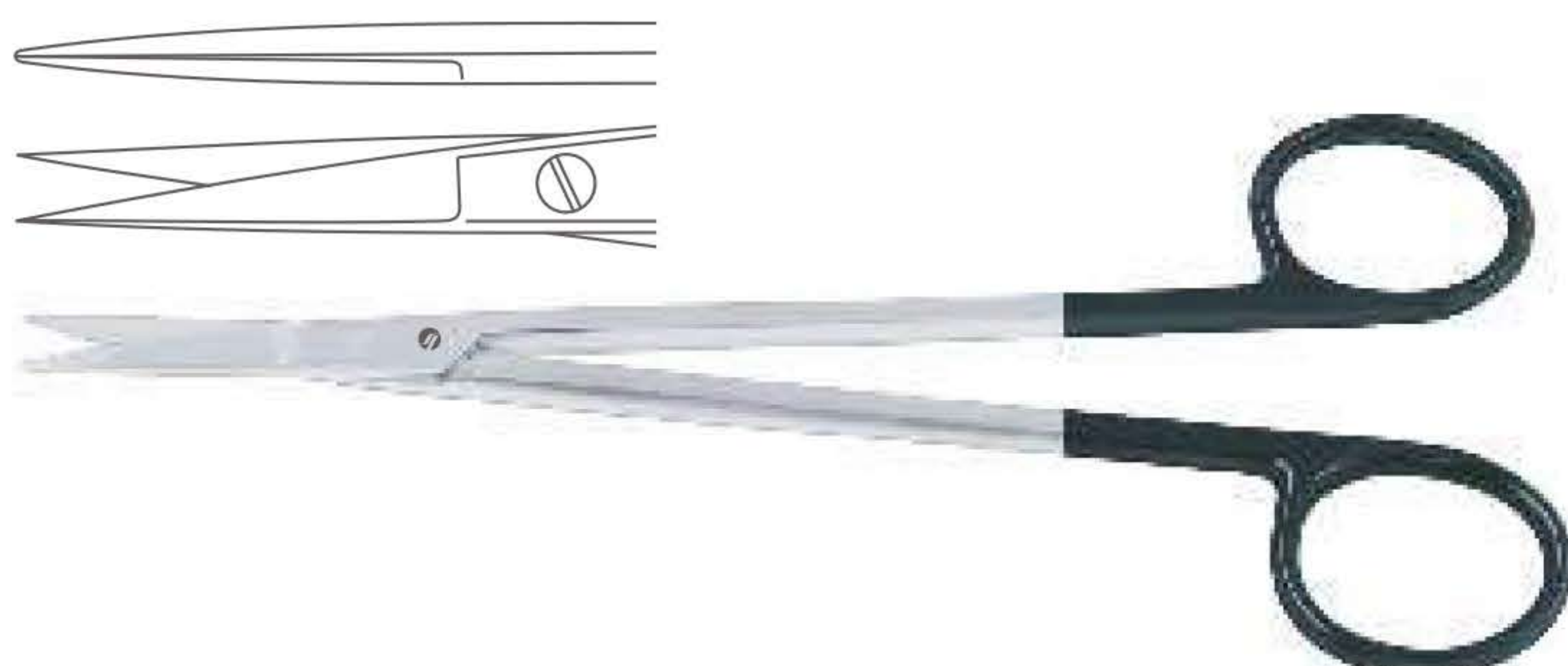

Dissecting Scissors  
 Präparierscheren  
 Tijeras de disección  
 Ciseaux à dissection  
 Forbici per dissezione

**Kelly Dissecting Scissor**  
 Curved

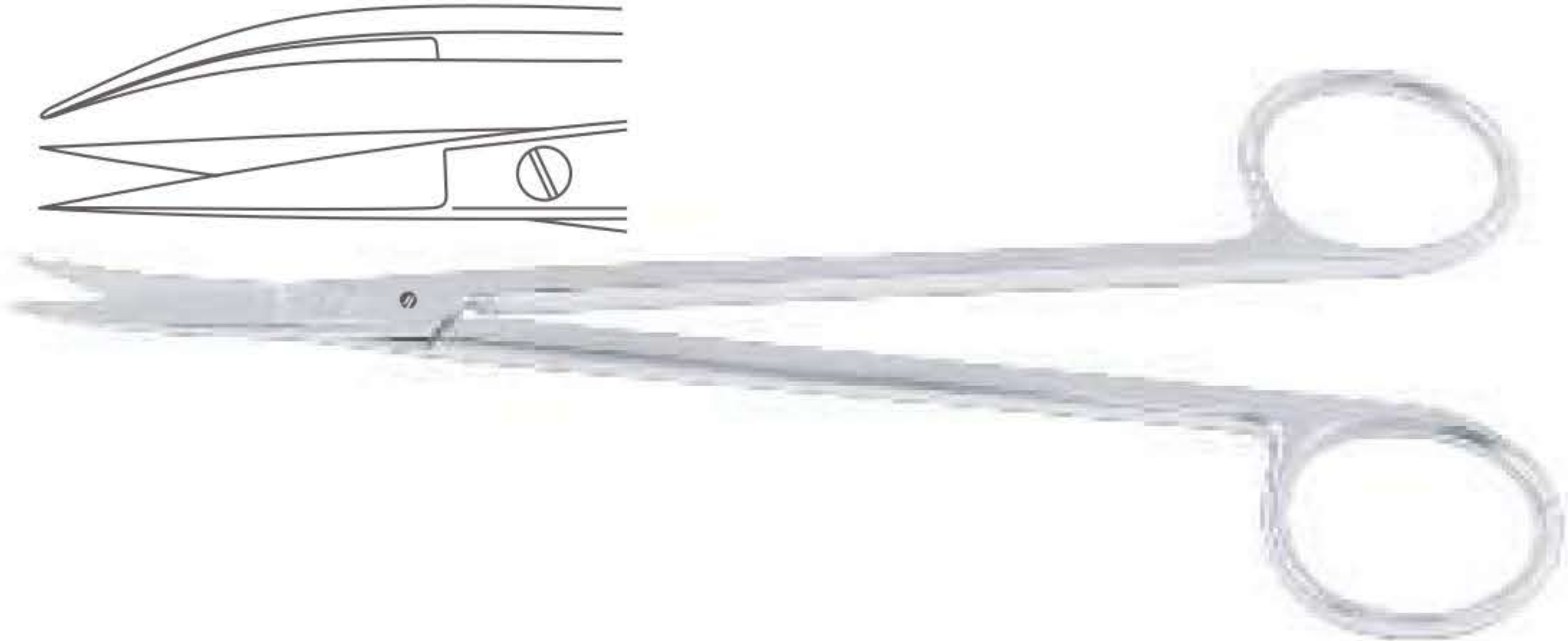

Catalog #	Size
SS-101-16	16 cm (6 1/4")

**Kelly Dissecting Scissor**  
 Curved

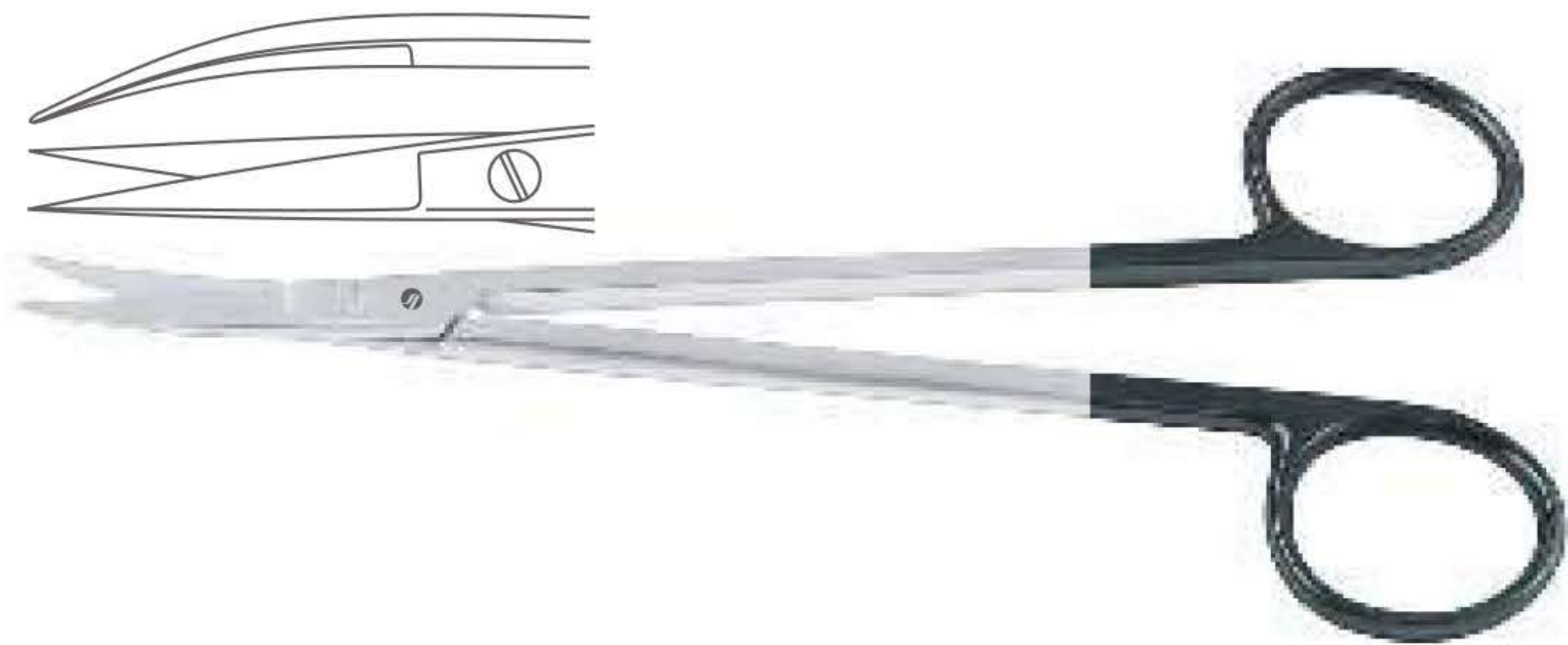

**SUPER Edge™**

Catalog #	Size
SS-101-16 SC	16 cm (6 1/4")

**Joseph Dissecting Scissor**  
 Straight



Catalog #	Size
SS-104-15	15 cm (6")

**Joseph Dissecting Scissor**  
 Straight



**SUPER Edge™**

Catalog #	Size
SS-104-15 SC	15 cm (6")

**Joseph Dissecting Scissor**  
 Curved



Catalog #	Size
SS-105-15	15 cm (6")

Dissecting Scissors  
 Präparierscheren  
 Tijeras de disección  
 Ciseaux à dissection  
 Forbici per dissezione

**Joseph Dissecting Scissor**  
 Curved

**SUPER** *Edge*<sup>™</sup>

Catalog #	Size
SS-105-15 SC	15 cm (6")

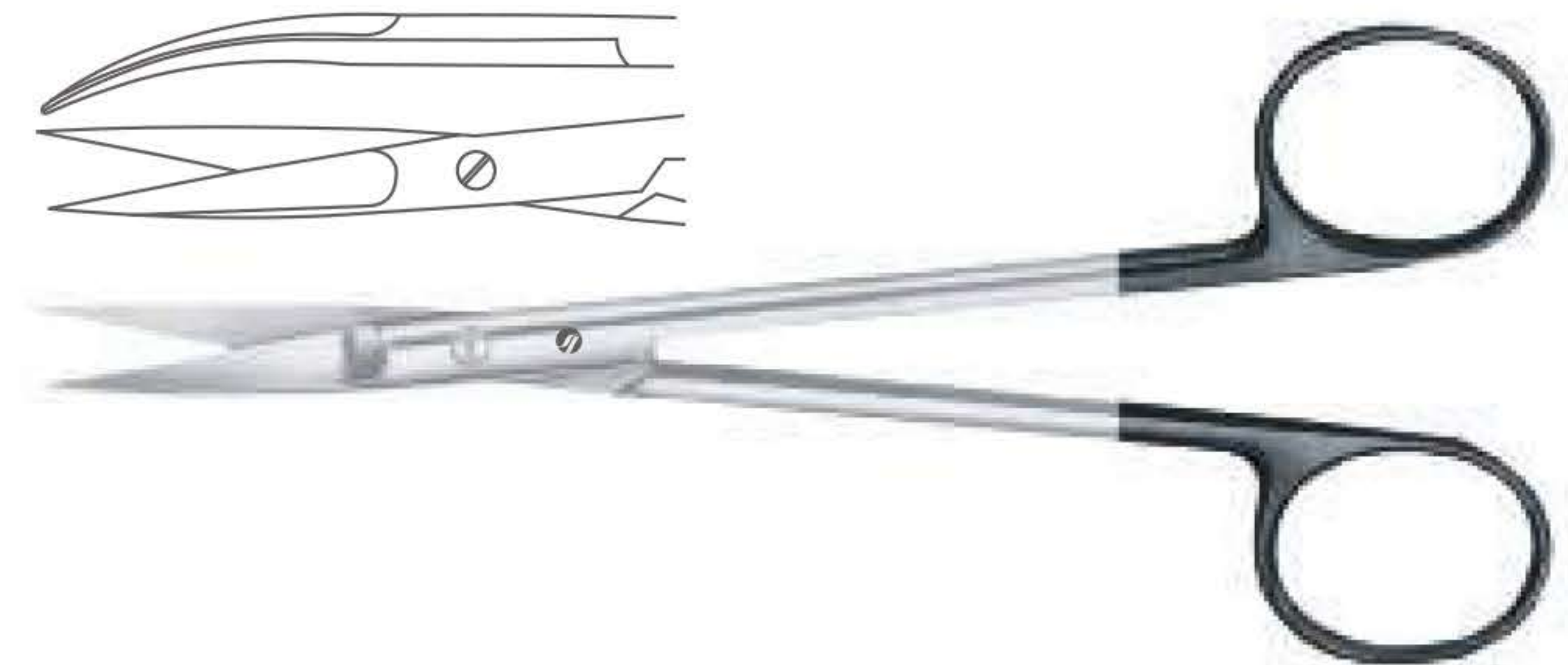

**Weller Dissecting Scissor**  
 Heavy Pattern

Catalog #	Size
SS-111-28	28 cm (11")



**Resano Cartilage Scissor**

Catalog #	Size
SS-113-25	25 cm (9 3/4")

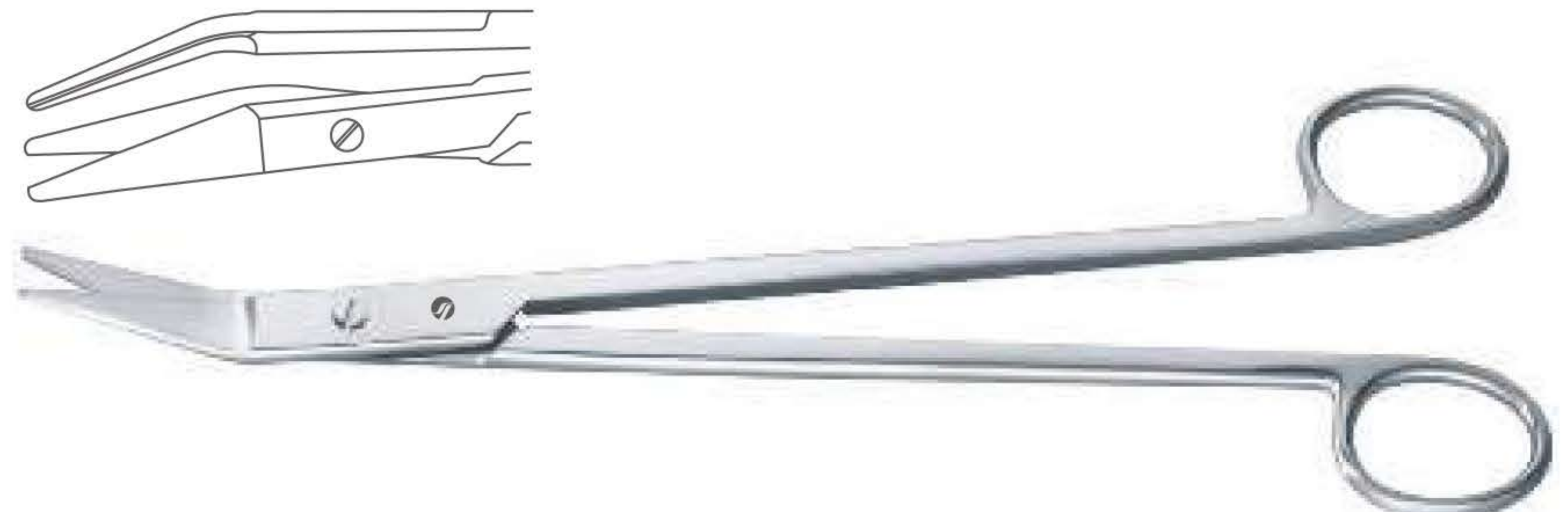

**Metzenbaum Dissecting Scissor**  
 Straight, Blunt/Blunt

Catalog #	Size
SS-120-11	11.5 cm (4 1/2")

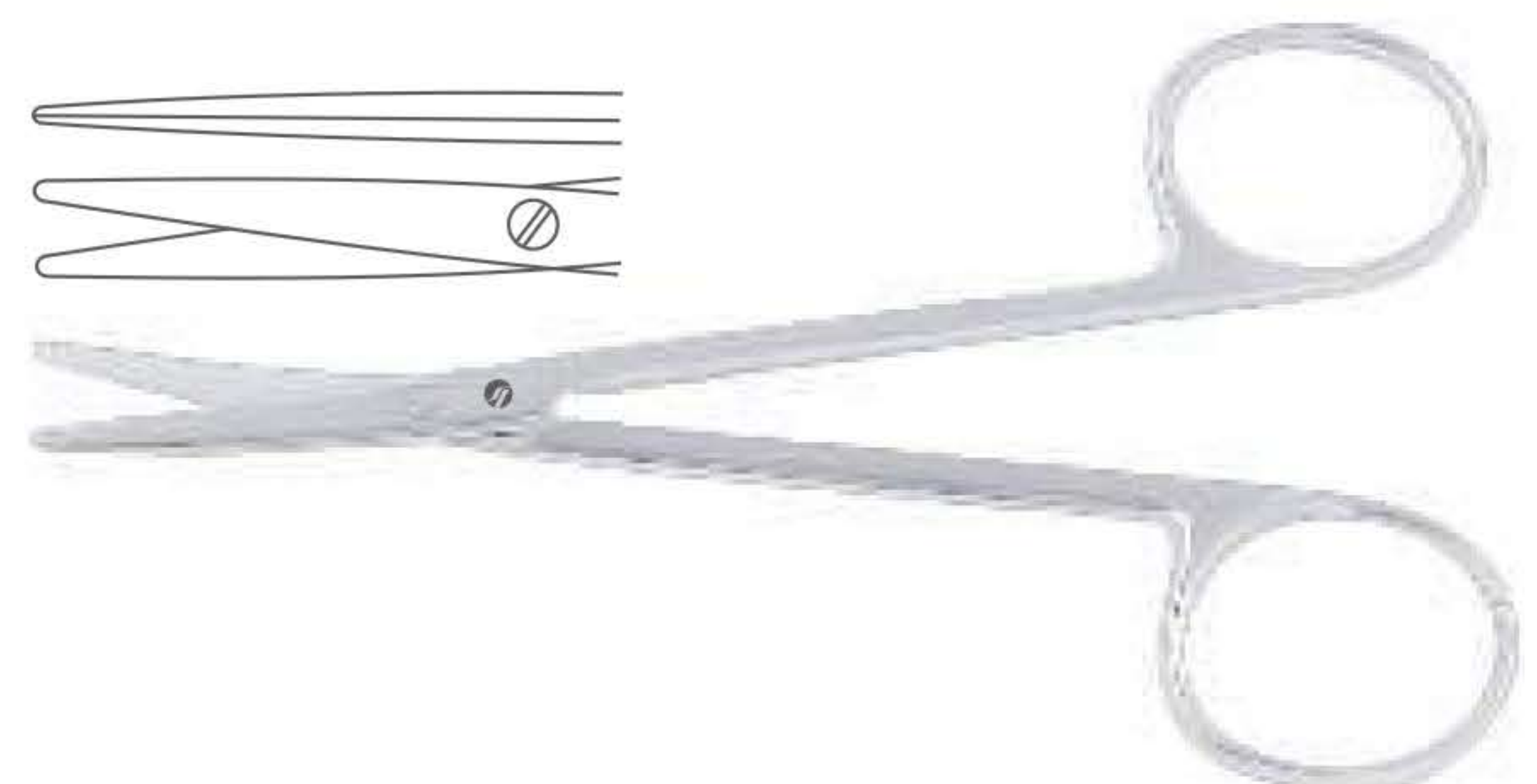

**Metzenbaum Dissecting Scissor**  
 Straight, Blunt/Blunt

**SUPER** *Edge*<sup>™</sup>

Catalog #	Size
SS-120-11 SC	11.5 cm (4 1/2")

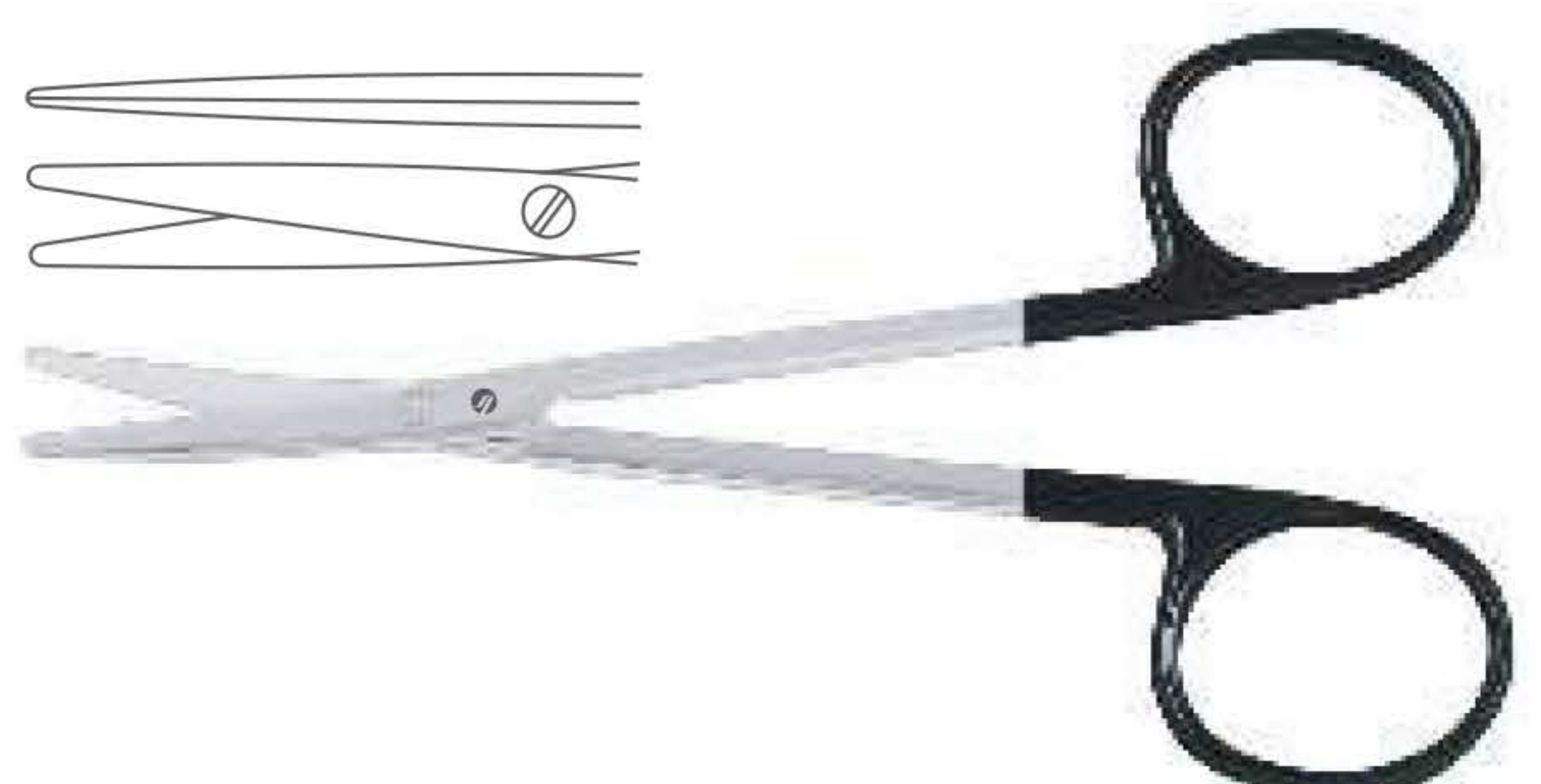

Dissecting Scissors  
 Präparierscheren  
 Tijeras de disección  
 Ciseaux à dissection  
 Forbici per dissezione

**Metzenbaum Dissecting Scissor**  
 Straight, Blunt/Blunt

**SUPER Edge™**

Catalog #	Size
SS-122-15 SC	15.5 cm (6")



**Metzenbaum Dissecting Scissor**  
 Curved, Blunt/Blunt

Catalog #	Size
SS-123-15	15.5 cm (6")

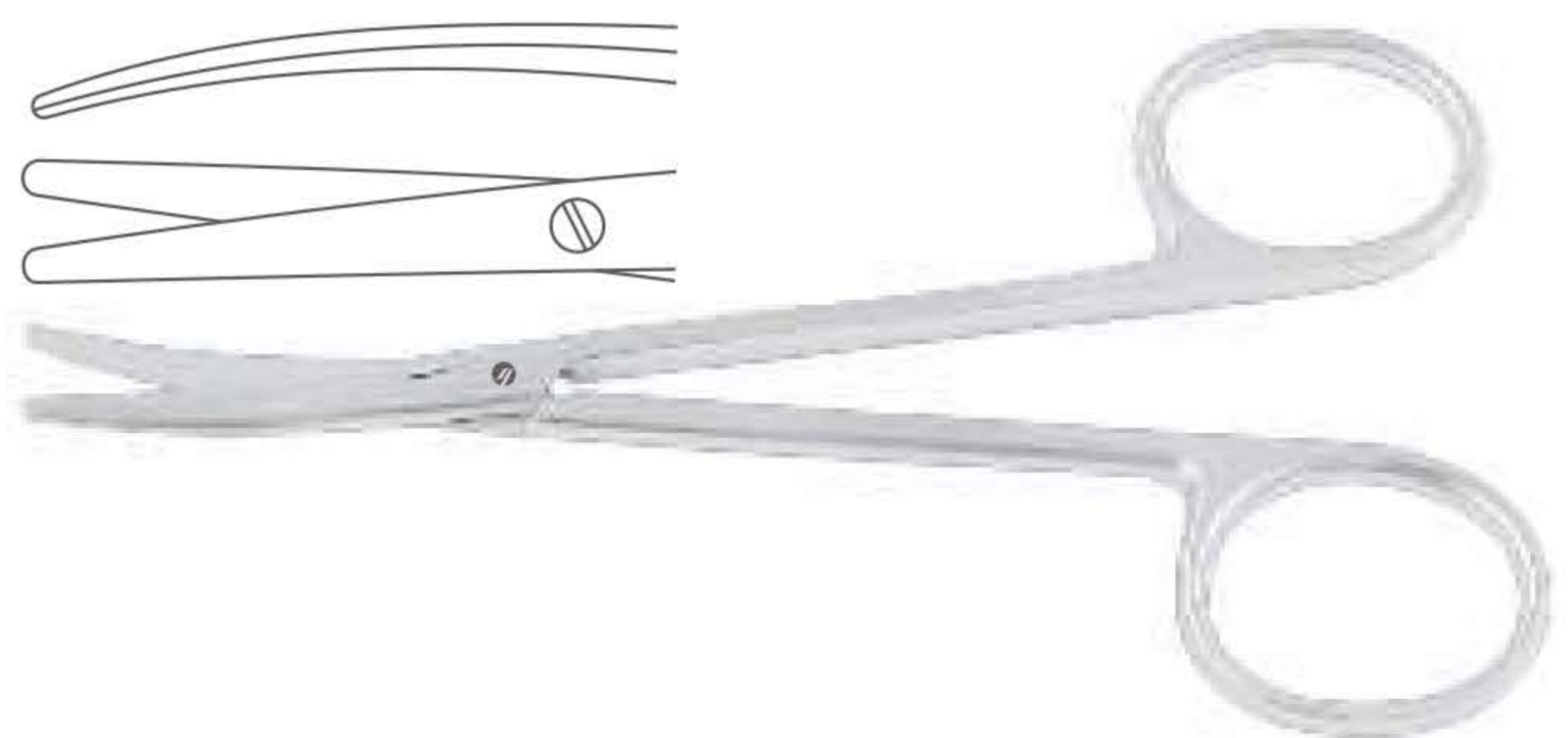

**Metzenbaum Dissecting Scissor**  
 Curved, Blunt/Blunt

**SUPER Edge™**

Catalog #	Size
SS-123-15 SC	15.5 cm (6")



**Metzenbaum Dissecting Scissor**  
 Straight, Blunt/Blunt

Catalog #	Size
SS-130-14	14.5 cm (5 3/4")



**Metzenbaum Dissecting Scissor**  
 Straight, Blunt/Blunt

**SUPER Edge™**

Catalog #	Size
SS-130-14 SC	14.5 cm (5 3/4")



Dissecting Scissors  
 Präparierscheren  
 Tijeras de disección  
 Ciseaux à dissection  
 Forbici per dissezione

**Metzenbaum Dissecting Scissor**  
 Curved, Blunt/Blunt

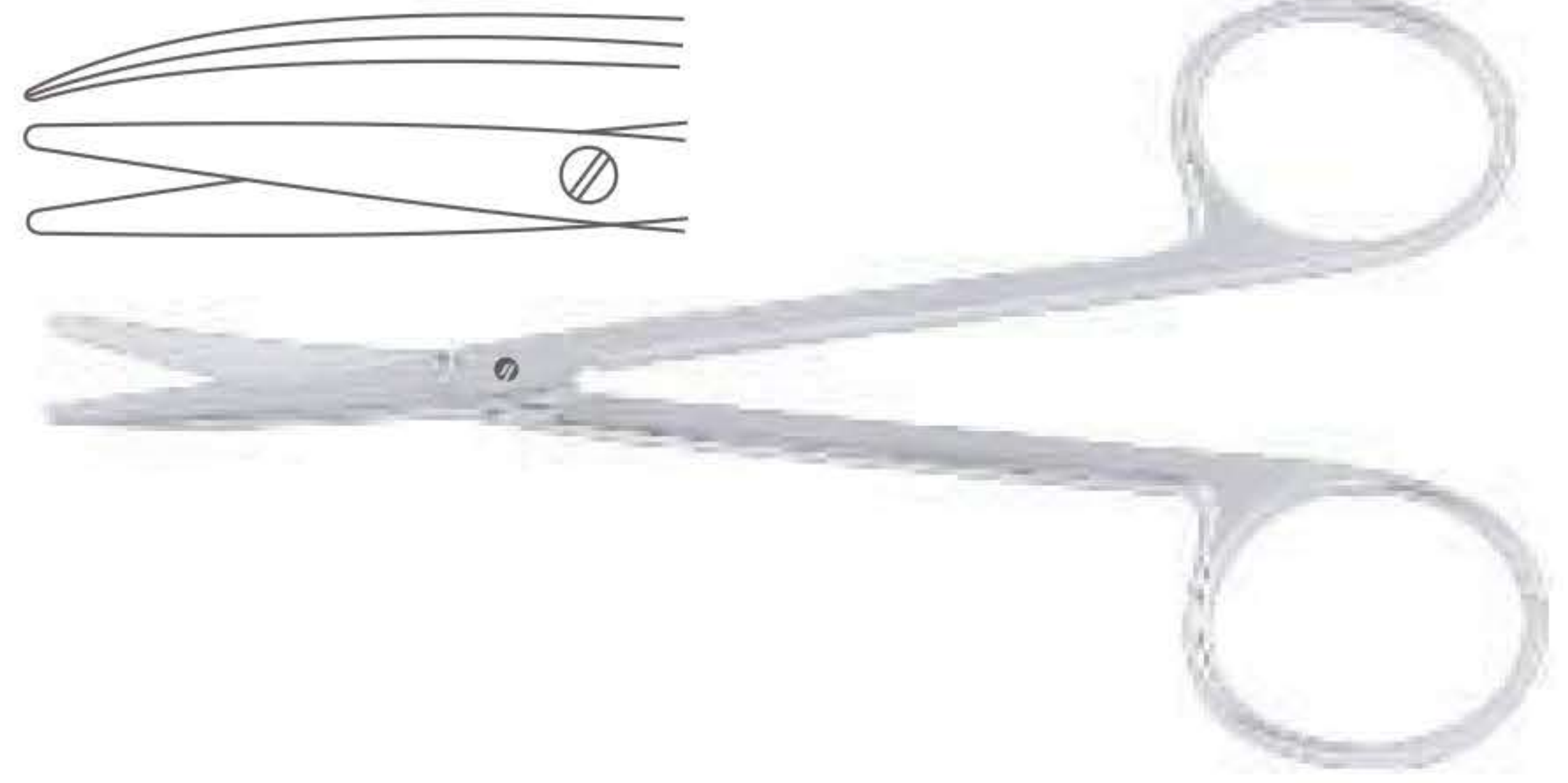

Catalog #	Size
SS-121-11	11.5 cm (4 1/2")

**Metzenbaum Dissecting Scissor**  
 Curved, Blunt/Blunt

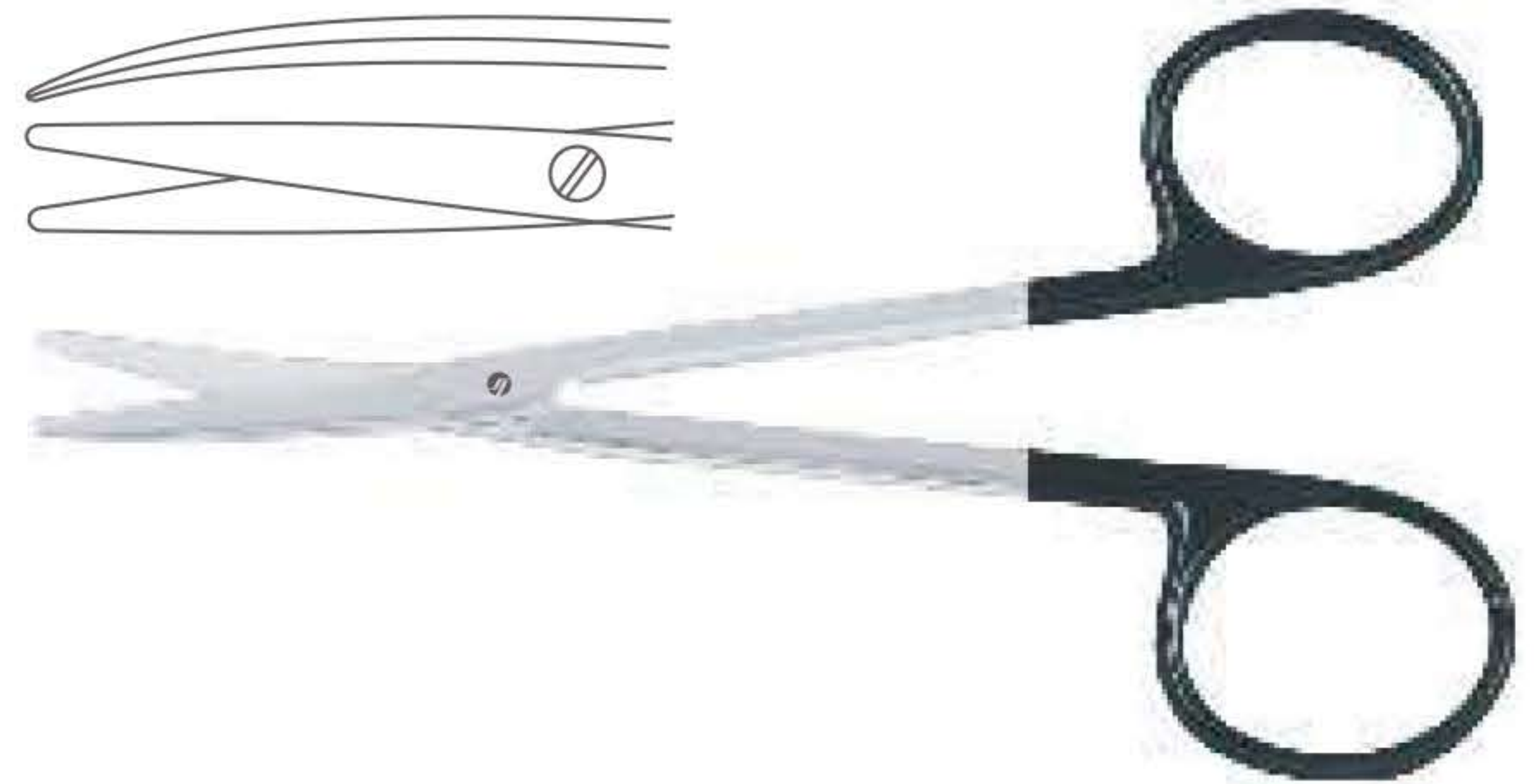

**SUPER Edge™**

Catalog #	Size
SS-121-11 SC	11.5 cm (4 1/2")

**Metzenbaum Dissecting Scissor**  
 Straight, Blunt/Blunt



Catalog #	Size
SS-122-15	15.5 cm (6")

**Metzenbaum Dissecting Scissor**  
 Curved, Blunt/Blunt

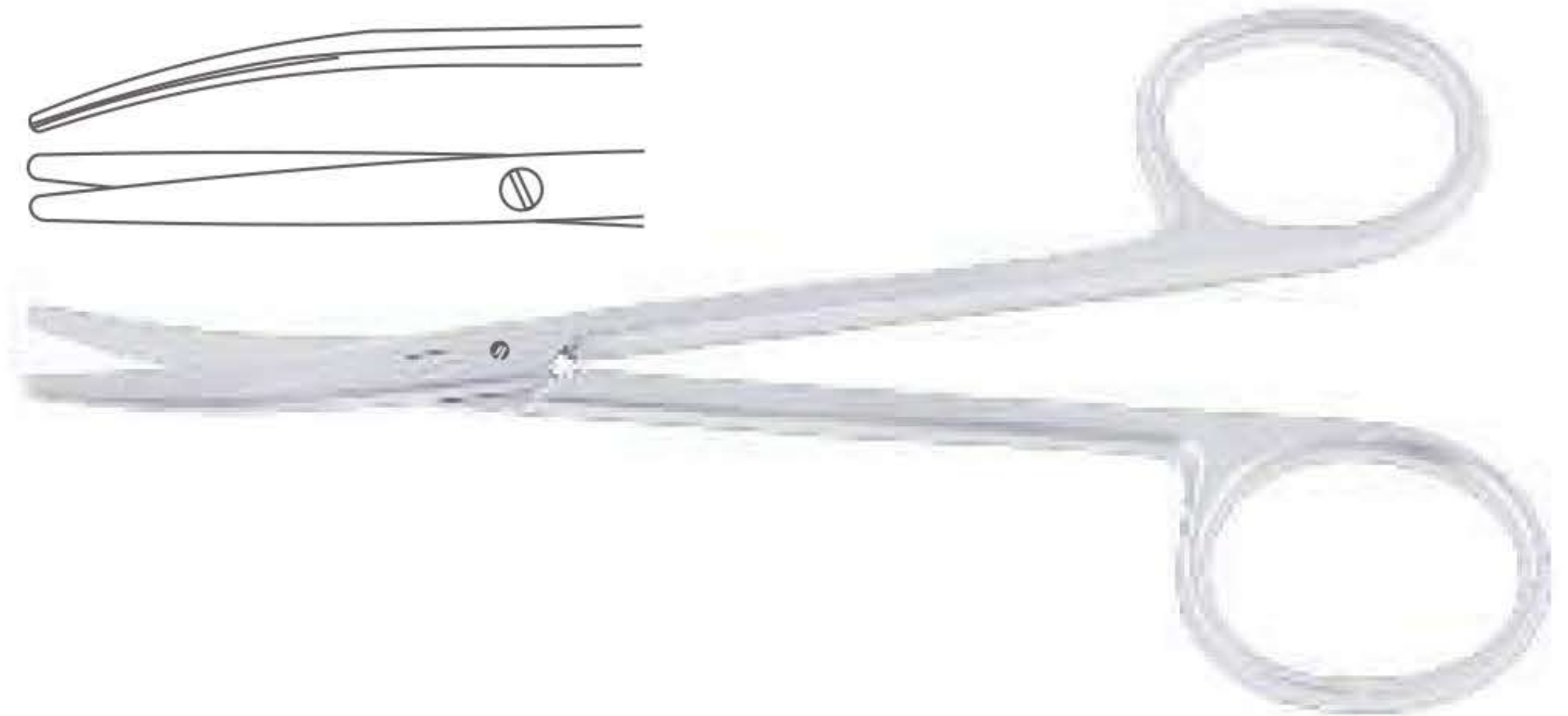

Catalog #	Size
SS-131-14	14.5 cm (5 3/4")

**Metzenbaum Dissecting Scissor**  
 Curved, Blunt/Blunt



**SUPER Edge™**

Catalog #	Size
SS-131-14 SC	14.5 cm (5 3/4")

Dissecting Scissors  
 Präparierscheren  
 Tijeras de disección  
 Ciseaux à dissection  
 Forbici per dissezione

**Metzenbaum Dissecting Scissor**  
 Straight, Sharp/Blunt

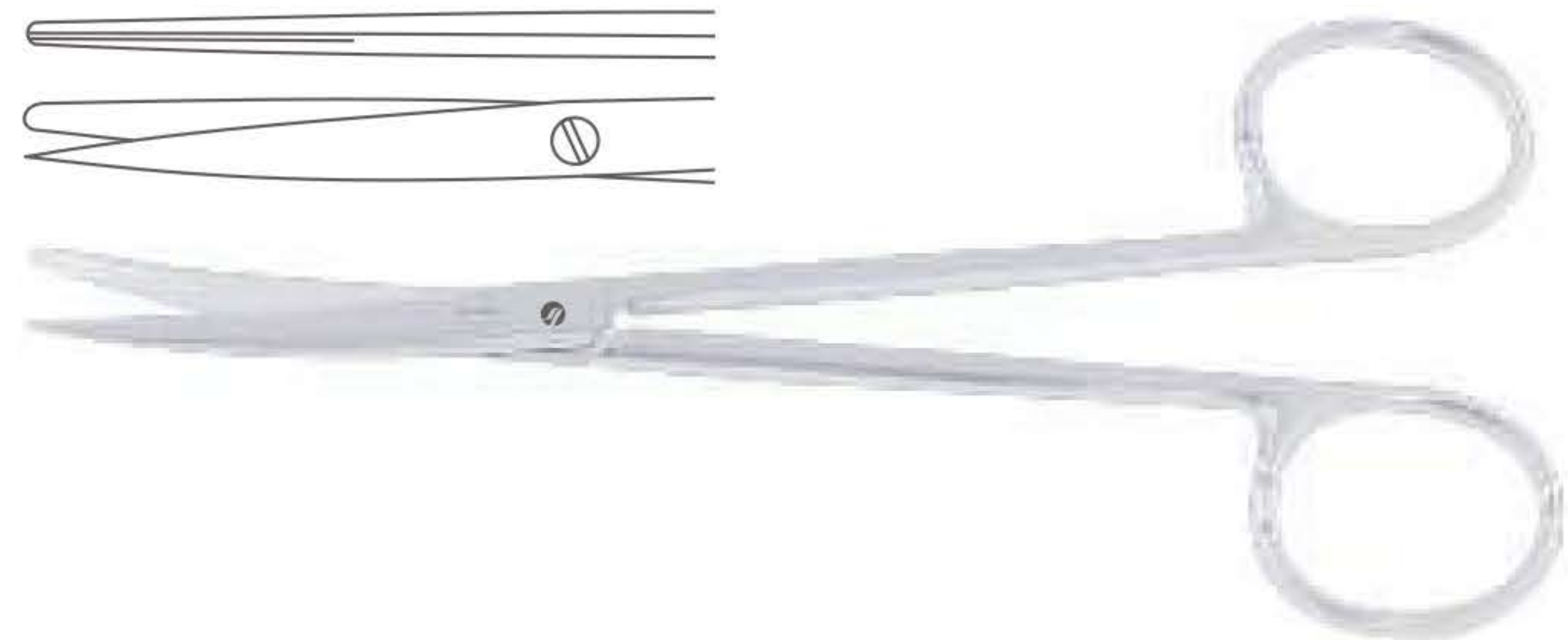

Catalog #	Size
SS-132-14	14.5 cm (5 ¾")

**Metzenbaum Dissecting Scissor**  
 Curved, Sharp/Blunt

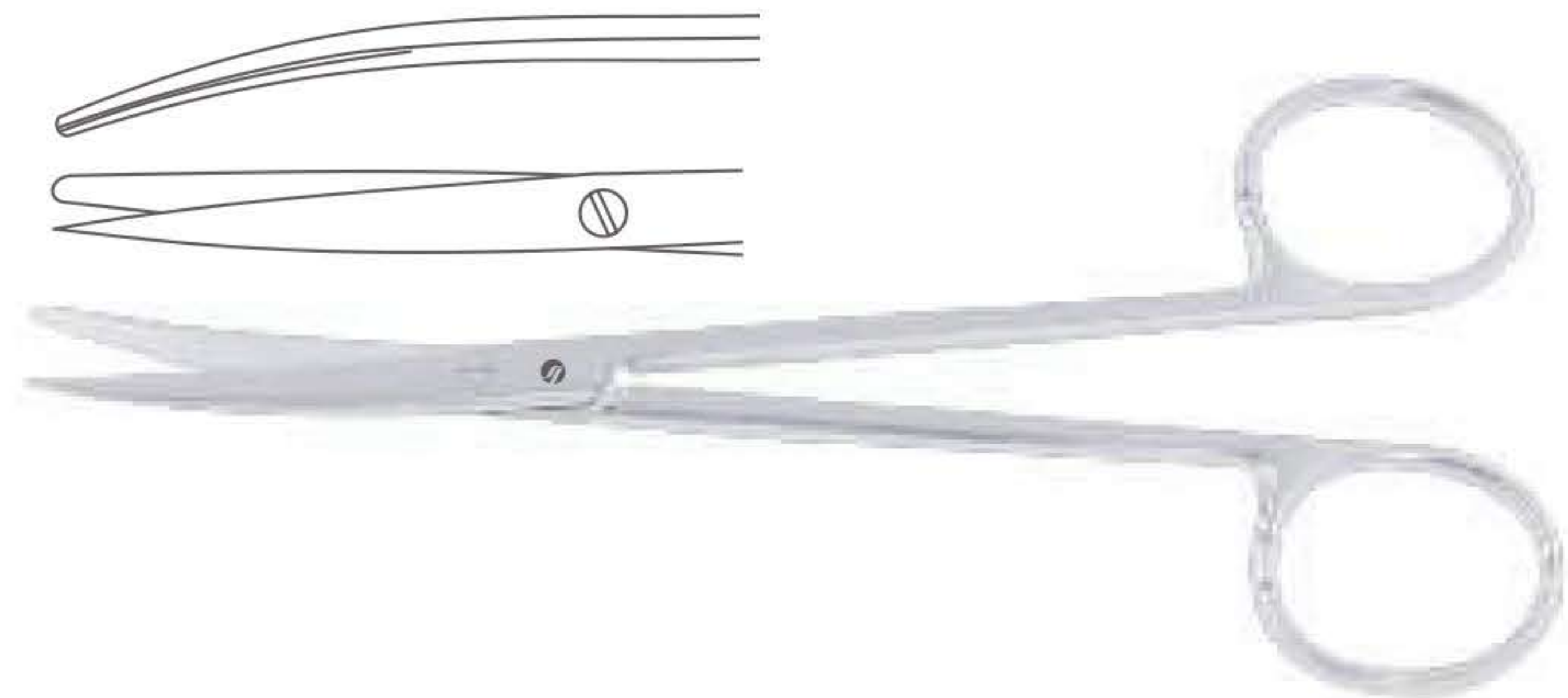

Catalog #	Size
SS-133-14	14.5 cm (5 ¾")

**Metzenbaum Dissecting Scissor**  
 Straight, Sharp/Sharp



Catalog #	Size
SS-134-14	14.5 cm (5 ¾")

**Metzenbaum Dissecting Scissor**  
 Curved, Sharp/Sharp



Catalog #	Size
SS-135-14	14.5 cm (5 ¾")

Dissecting Scissors  
 Präparierscheren  
 Tijeras de disección  
 Ciseaux à dissection  
 Forbici per dissezione

**Metzenbaum-Nelson Dissecting Scissor**  
 Straight, Blunt/Blunt

Catalog #	Size
SS-140-18	18 cm (7")
SS-140-20	20.5 cm (8")
SS-140-23	23 cm (9")
SS-140-26	26 cm (10 1/4")
SS-140-28	28.5 cm (11 1/4")
SS-140-30	31 cm (12 1/4")

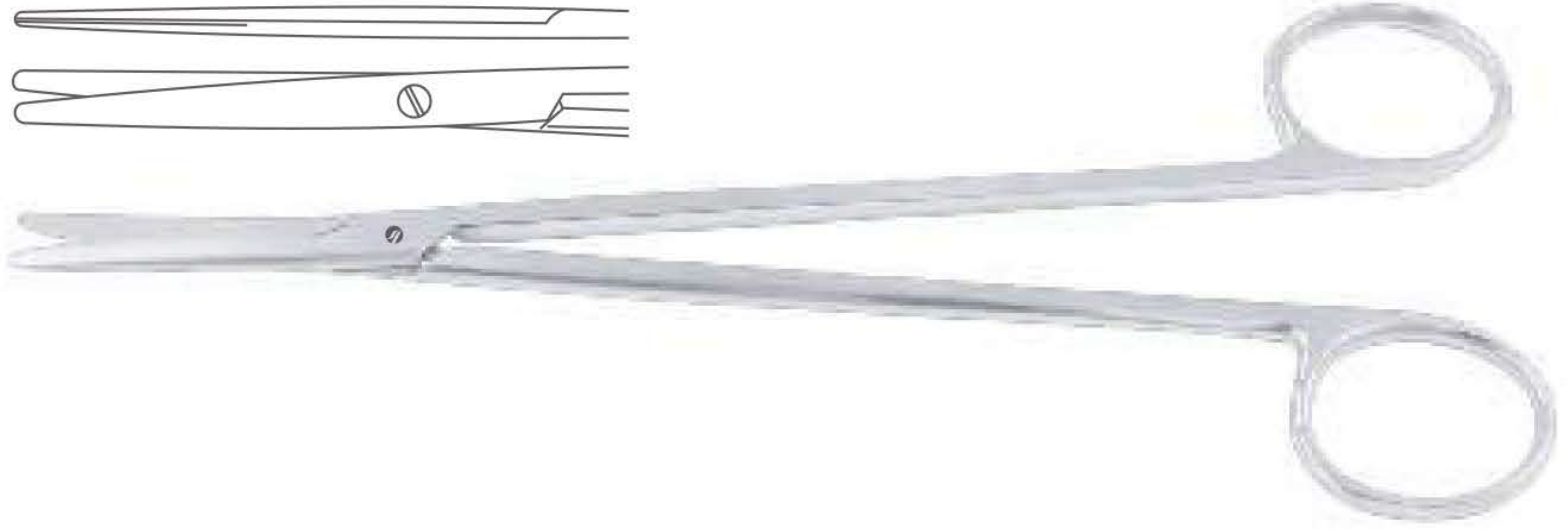

**Metzenbaum-Nelson Dissecting Scissor**  
 Straight, Blunt/Blunt

**SUPER Edge™**

Catalog #	Size
SS-140-18 SC	18 cm (7")
SS-140-20 SC	20.5 cm (8")
SS-140-23 SC	23 cm (9")
SS-140-26 SC	26 cm (10 1/4")

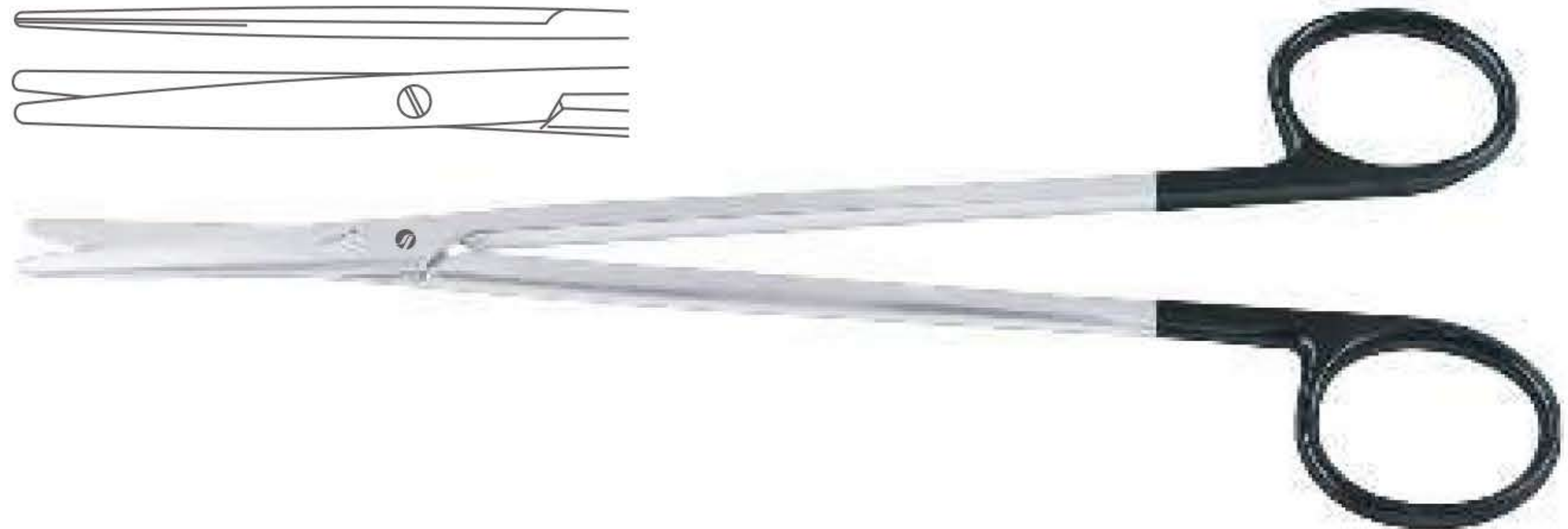

**Metzenbaum-Nelson Dissecting Scissor**  
 Curved, Blunt/Blunt

Catalog #	Size
SS-141-18	18 cm (7")
SS-141-20	20.5 cm (8")
SS-141-23	23 cm (9")
SS-141-26	26 cm (10 1/4")
SS-141-28	28.5 cm (11 1/4")
SS-141-30	31 cm (12 1/4")

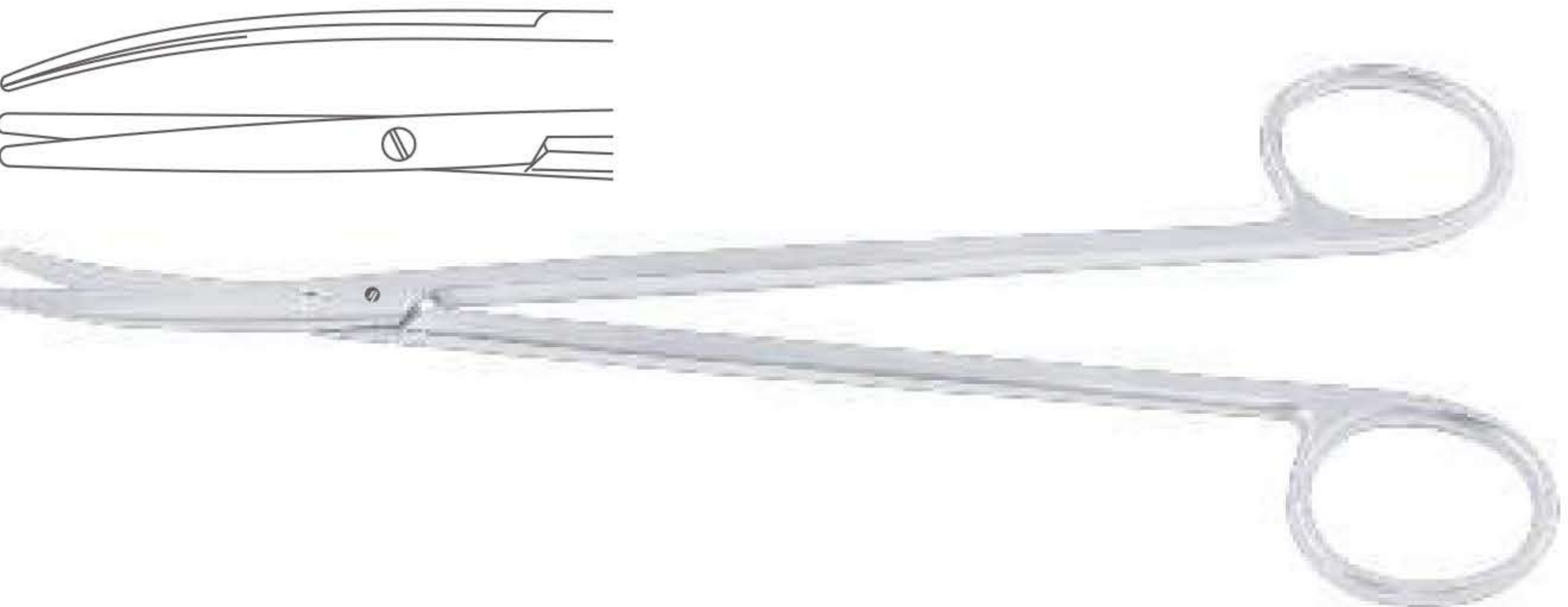

Dissecting Scissors  
 Präparierscheren  
 Tijeras de disección  
 Ciseaux à dissection  
 Forbici per dissezione

**Metzenbaum-Nelson Dissecting Scissor**  
 Curved, Blunt/Blunt

**SUPER Edge™**

Catalog #	Size
SS-141-18 SC	18 cm (7")
SS-141-20 SC	20.5 cm (8")
SS-141-23 SC	23 cm (9")
SS-141-26 SC	26 cm (10 1/4")

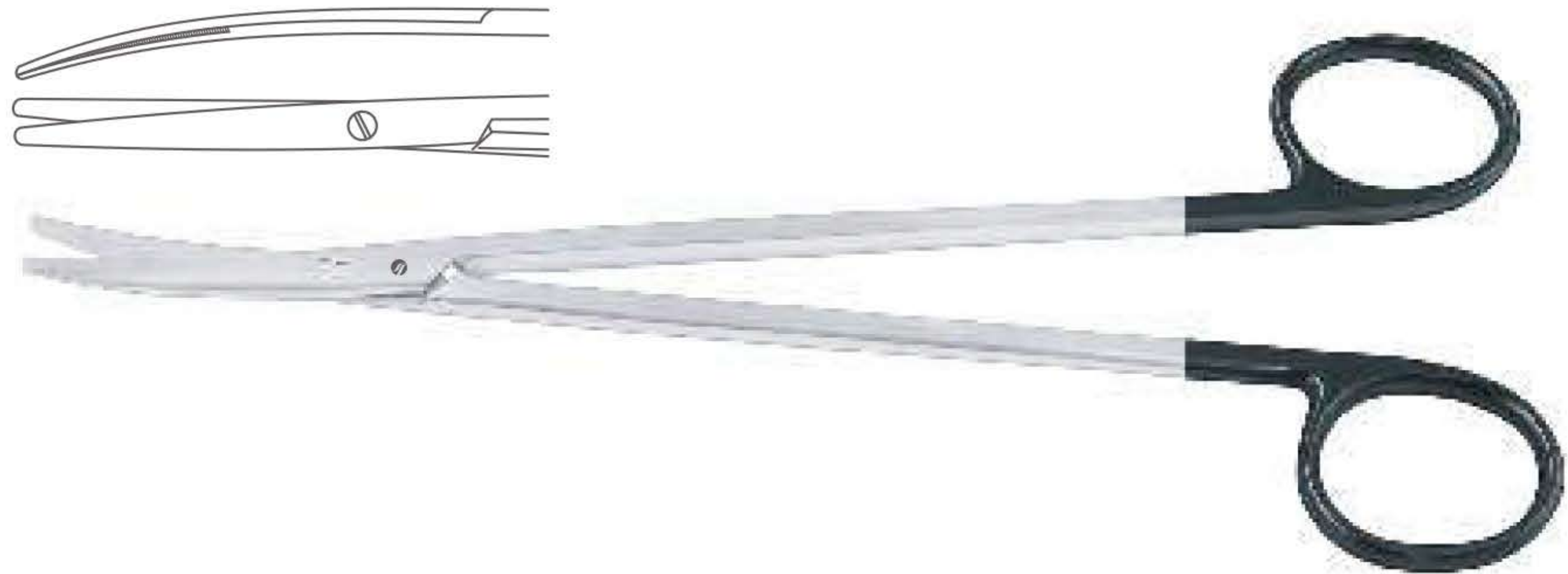

**Metzenbaum-Nelson Dissecting Scissor**  
 Straight, Sharp/Sharp

Catalog #	Size
SS-144-18	18 cm (7")
SS-144-20	20.5 cm (8")



**Metzenbaum Dissecting Scissor**  
 Straight, Sharp/Sharp, Toothed

Catalog #	Size
SS-146-14	14.5 cm (5 3/4")

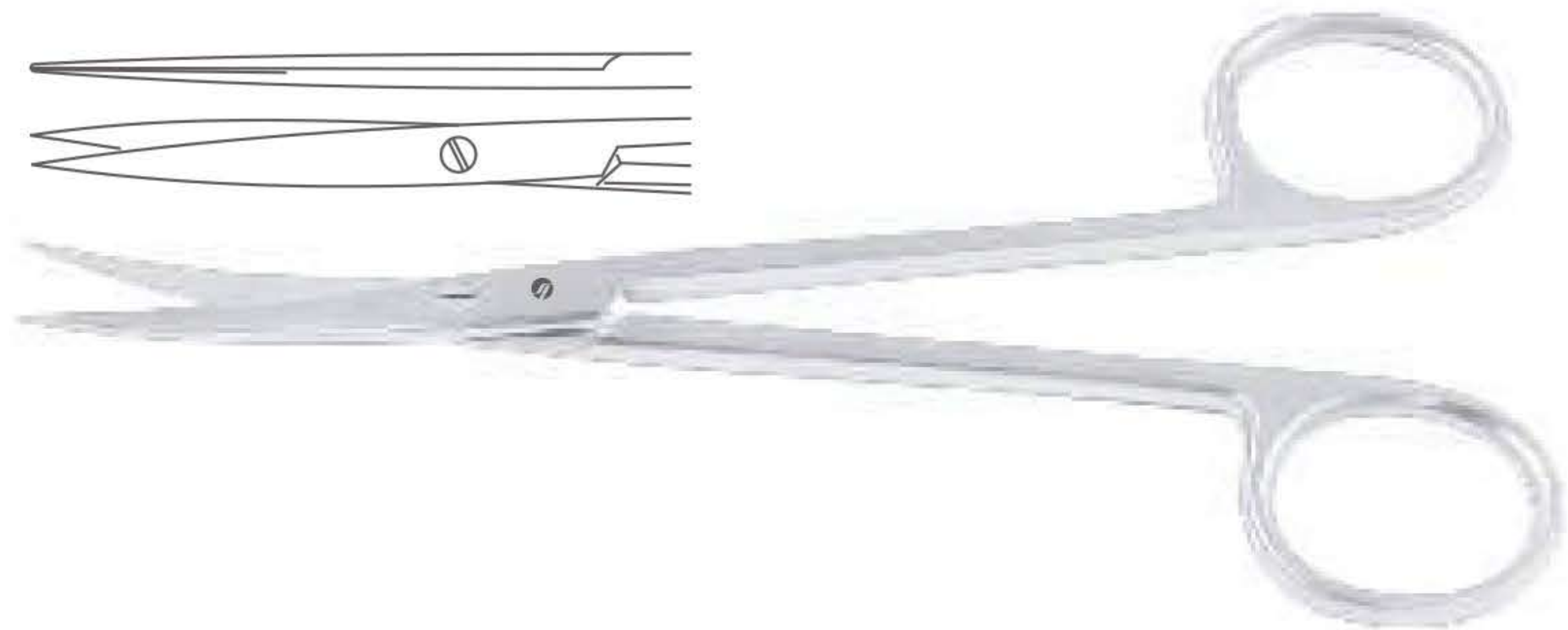

**Metzenbaum Dissecting Scissor**  
 Curved, Sharp/Sharp, Toothed

Catalog #	Size
SS-147-14	14.5 cm (5 3/4")



Dissecting Scissors, Face-lift Scissors  
 Präparierscheren, Face-lift-Scheren  
 Tijeras de disección, Tijeras para Face-Lift  
 Ciseaux à dissection, Ciseaux pour Face-lift  
 Forbici per dissezione, Forbici per Face-lift

**Metzenbaum Nerve Dissecting Scissor**  
 Straight

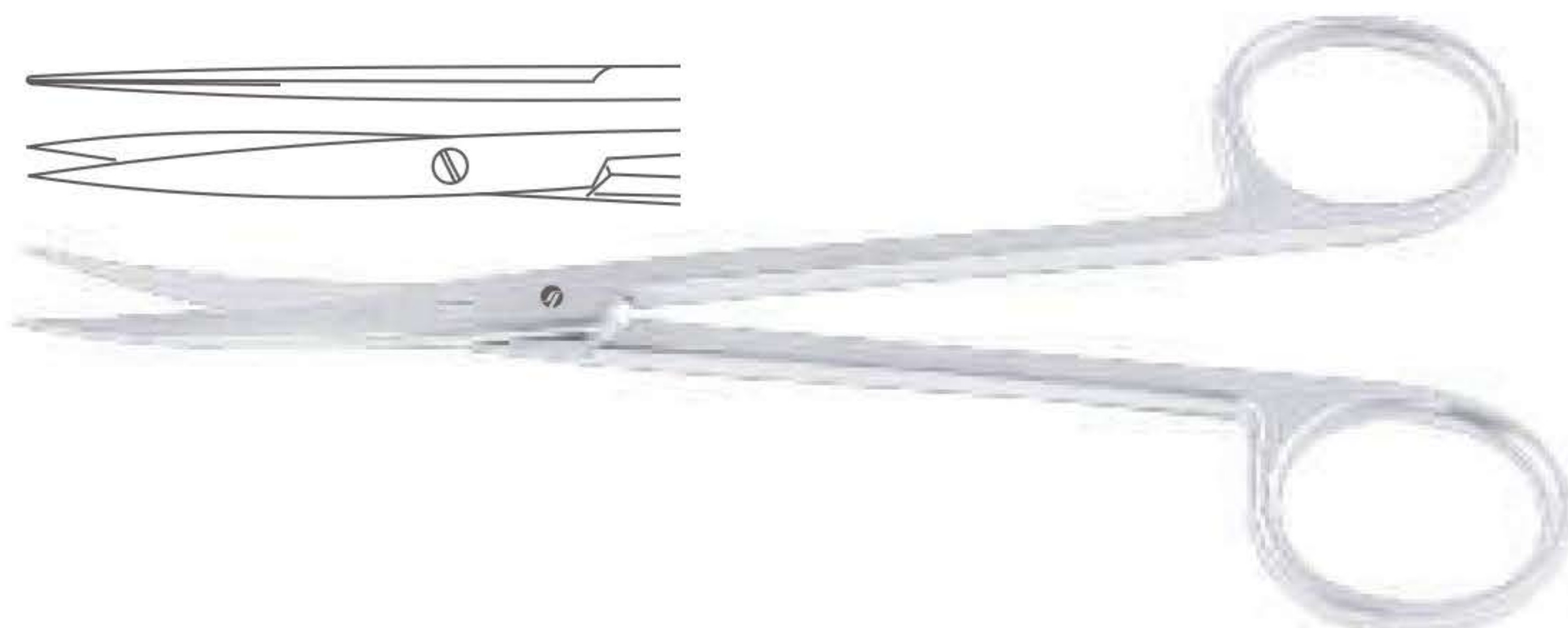

Catalog #	Size
SS-148-15	15.5 cm (6")

**Metzenbaum Nerve Dissecting Scissor**  
 Curved

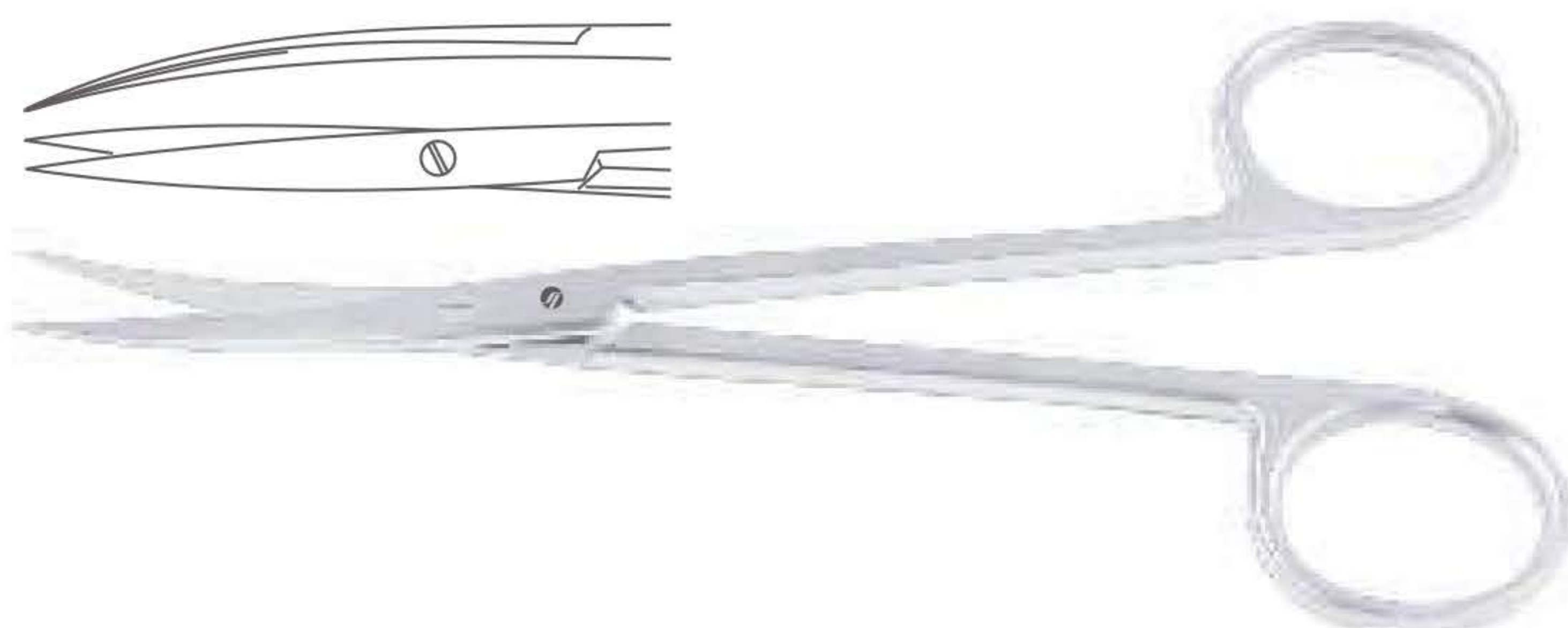

Catalog #	Size
SS-149-15	15.5 cm (6")

**McIndoe Cartilage Scissor**  
 Straight, Toothed

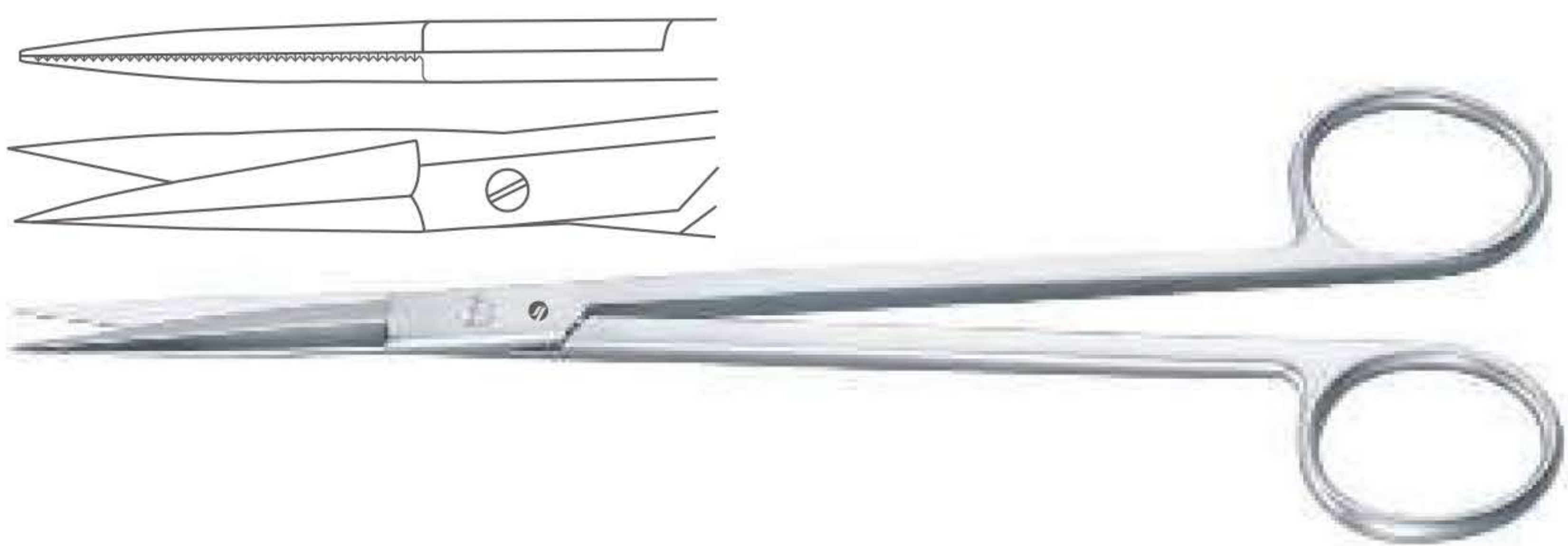

Catalog #	Size
SS-154-18	18.5 cm (7 1/4")

**McIndoe Cartilage Scissor**  
 Curved, Toothed



Catalog #	Size
SS-155-18	18.5 cm (7 1/4")

**Kaye Face-Lift Scissor**  
 Curved

**SUPER** Edge™



Catalog #	Size
SS-161-18 SC	18.5 cm (7 1/4")

Face-lift Scissors, Dissecting Scissors  
 Face-lift-Scheren, Präparierscheren  
 Tijeras para Face-Lift, Tijeras de disección  
 Ciseaux pour Face-lift, Ciseaux à dissection  
 Forbici per Face-lift, Forbici per dissezione

**Gorney Face-Lift Scissor**  
 Straight

**SUPER Edge™**

Catalog #	Size
SS-166-12 SC	12.5 cm (5")
SS-166-19 SC	19.5 cm (7 ¾")



**Gorney Face-Lift Scissor**  
 Curved

**SUPER Edge™**

Catalog #	Size
SS-167-19 SC	19.5 cm (7 ¾")



**Aston Face-Lift Scissor**  
 Straight

**SUPER Edge™**

Catalog #	Size
SS-170-17 SC	17 cm (6 ¾")



**Lexer Dissecting Scissor**  
 Straight

Catalog #	Size
SS-176-16	16 cm (6 ¼")



**Lexer Dissecting Scissor**  
 Straight

**SUPER Edge™**

Catalog #	Size
SS-176-16 SC	16 cm (6 ¼")



Dissecting Scissors, Nasal Scissors  
 Präparierscheren, Nasenscheren  
 Tijeras de disección, Tijeras nasales  
 Ciseaux à dissection, Ciseaux nasaux  
 Forbici per dissezione, Forbici nasali

**Lexer Dissecting Scissor**  
 Curved



Catalog #	Size
SS-177-16	16 cm (6 ¼")

**Lexer Dissecting Scissor**  
 Curved

**SUPER Edge™**



Catalog #	Size
SS-177-16 SC	16 cm (6 ¼")

**Cottle-Masing Plastic Surgery Scissor**  
 Curved, Sharp/Sharp

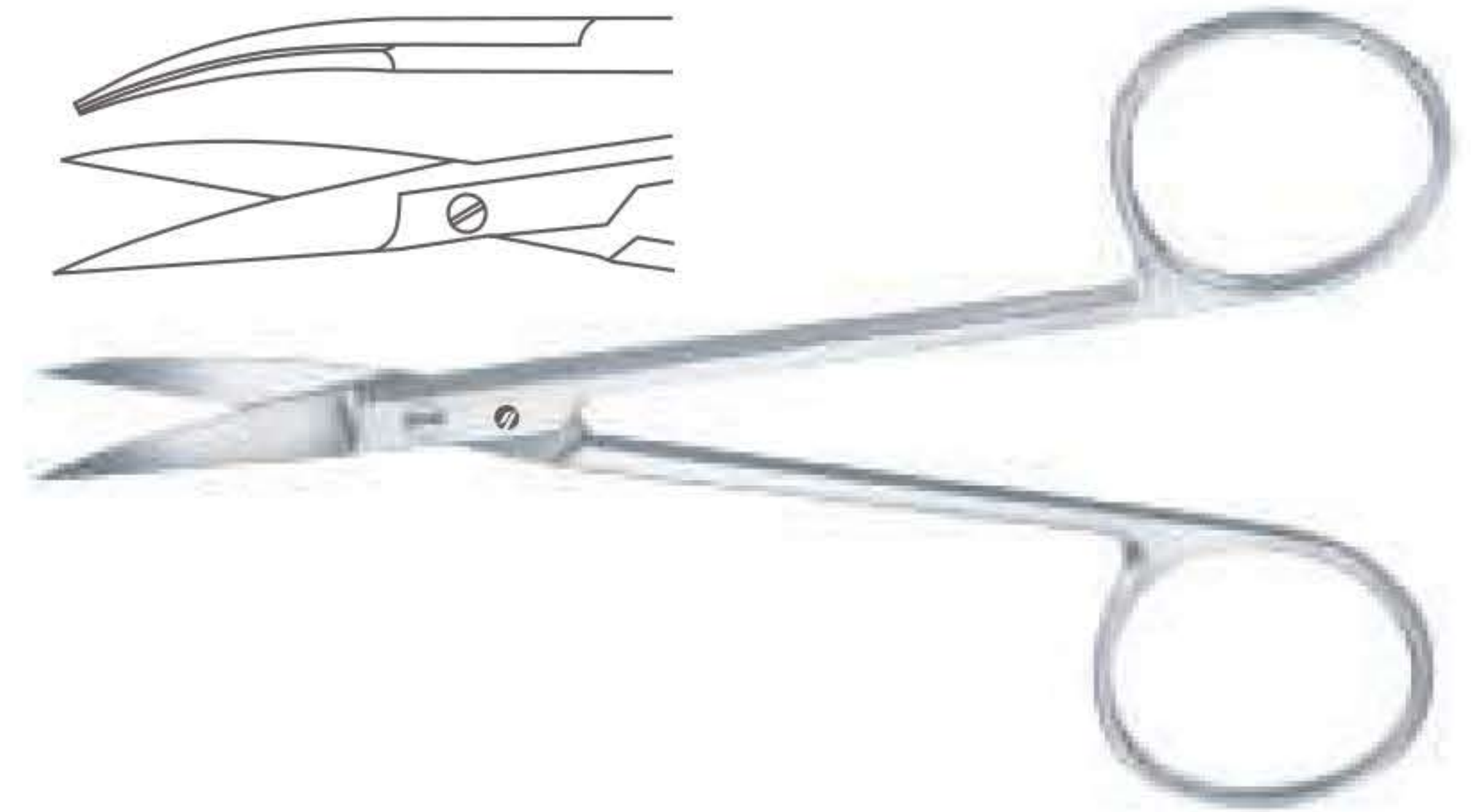

Catalog #	Size
SS-181-10	10.5 cm (4 ¼")

**Cottle-Masing Plastic Surgery Scissor**  
 Curved, Blunt/Blunt

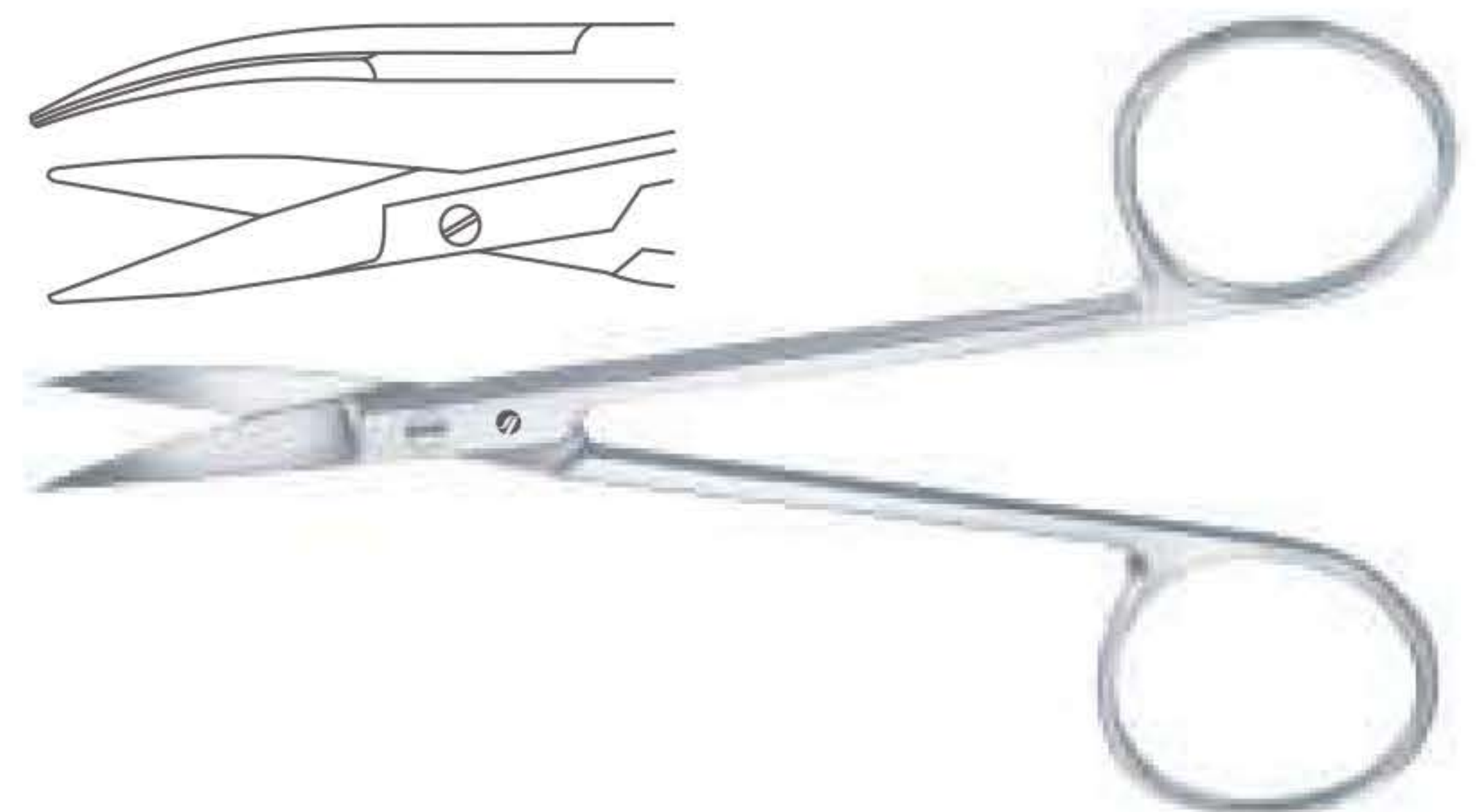

Catalog #	Size
SS-183-10	10.5 cm (4 ¼")

**Cinelli Nasal Scissor**  
 Curved



Catalog #	Size
SS-187-11	11.5 cm (4 ½")

Nasal Scissors, Delicate Dissecting Scissors  
 Nasenscheren, Feine Präparierscheren  
 Tijeras nasales, Tijeras finas de disección  
 Ciseaux nasaux, Ciseaux fins à dissection  
 Forbici nasali, Forbici fini per dissezione

**Fomon Nasal Scissor**  
 Curved



Catalog #	Size
SS-189-14	14 cm (5 1/2")

**Thorek Dissecting Scissor**  
 Curved



Catalog #	Size
SS-191-19	18.5 cm (7 1/4")

**Lexer-Baby Dissecting Scissor**  
 Straight



Catalog #	Size
SS-194-10	10 cm (4")

**Lexer-Baby Dissecting Scissor**  
 Curved

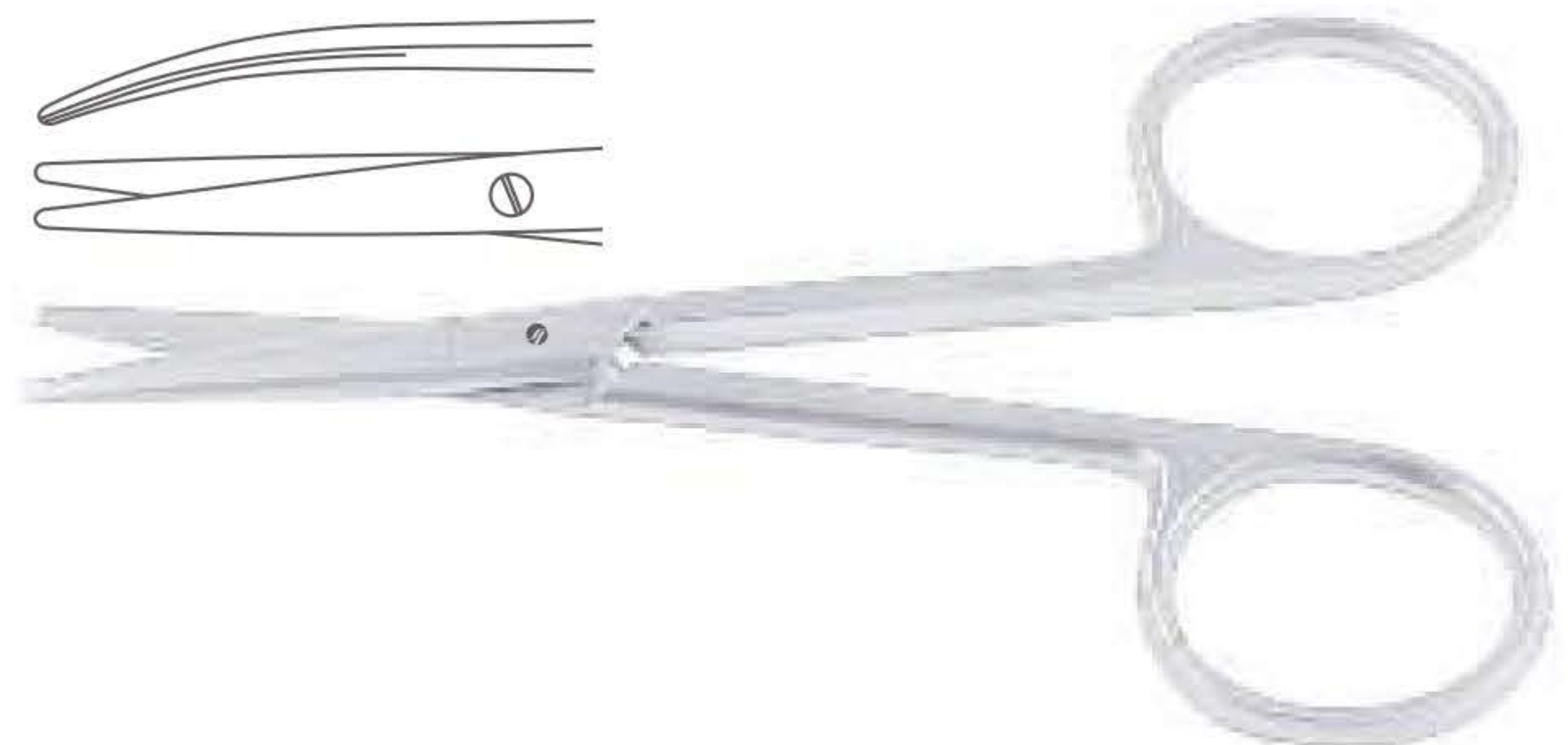

Catalog #	Size
SS-195-10	10 cm (4")

**Lexer-Fine Delicate Dissecting Scissor**  
 Straight, Slender Pattern



Catalog #	Size
SS-196-16	16.5 cm (6 1/2")

Delicate Dissecting Scissors  
 Feine Präparierscheren  
 Tijeras finas de disección  
 Ciseaux fins à dissection  
 Forbici fini per dissezione

**Lexer-Fine Delicate Dissecting Scissor**  
 Curved, Slender Pattern



Catalog #	Size
SS-197-16	16.5 cm (6 1/2")

**Metzenbaum-Fine Delicate Dissecting Scissor**  
 Straight, Blunt/Blunt, Slender Pattern



Catalog #	Size
SS-200-14	14.5 cm (5 3/4")

**Metzenbaum-Fine Delicate Dissecting Scissor**  
 Straight, Blunt/Blunt, Slender Pattern



**SUPER Edge™**

Catalog #	Size
SS-200-14 SC	14.5 cm (5 3/4")

**Metzenbaum-Fine Delicate Dissecting Scissor**  
 Curved, Blunt/Blunt, Slender Pattern

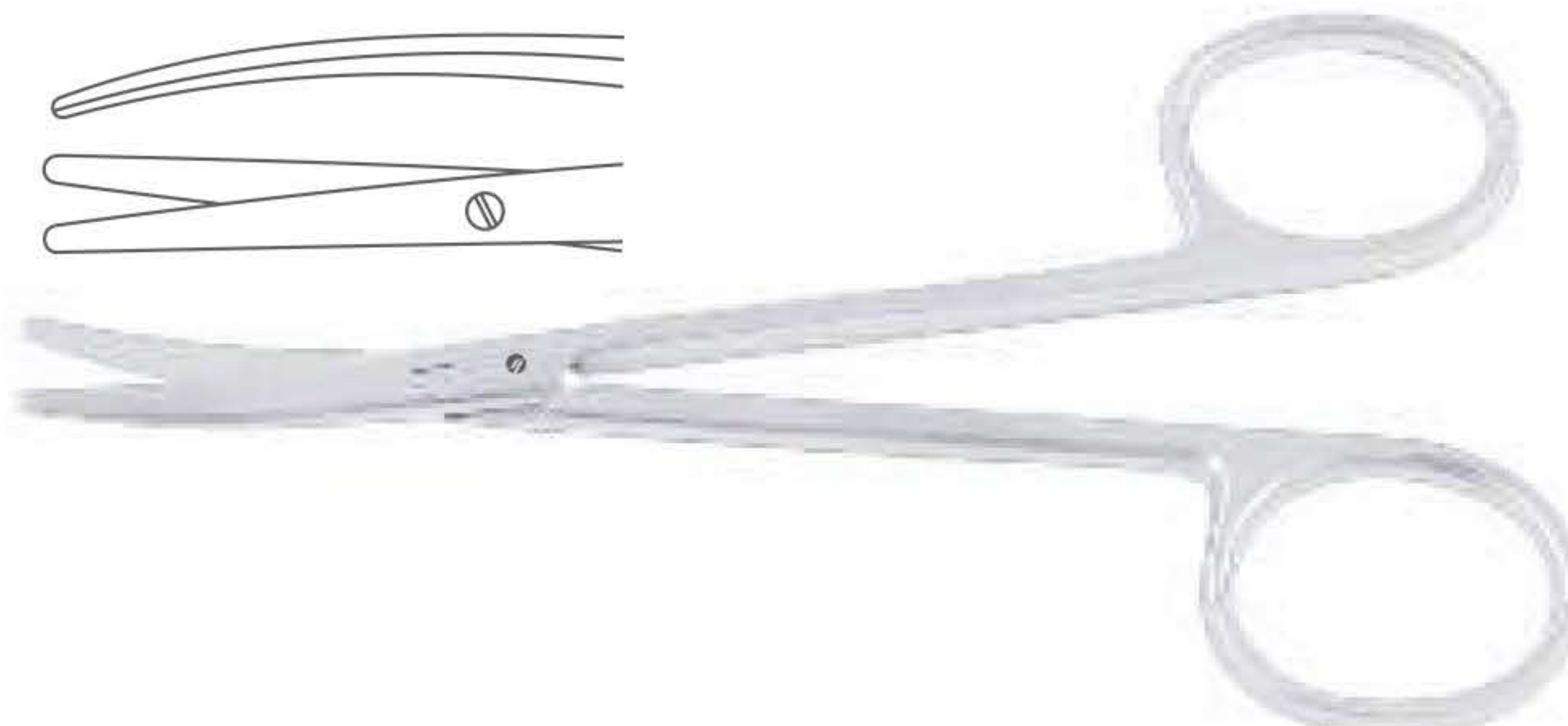

Catalog #	Size
SS-201-14	14.5 cm (5 3/4")

**Metzenbaum-Fine Delicate Dissecting Scissor**  
 Curved, Blunt/Blunt, Slender Pattern



**SUPER Edge™**

Catalog #	Size
SS-201-14 SC	14.5 cm (5 3/4")

Delicate Dissecting Scissors  
 Feine Präparierscheren  
 Tijeras finas de disección  
 Ciseaux fins à dissection  
 Forbici fini per dissezione

**Metzenbaum-Fine Delicate Dissecting Scissor**  
 Straight, Sharp/Sharp, Slender Pattern



Catalog #	Size
SS-202-14	14.5 cm (5 3/4")

**Metzenbaum-Fine Delicate Dissecting Scissor**  
 Curved, Sharp/Sharp, Slender Pattern

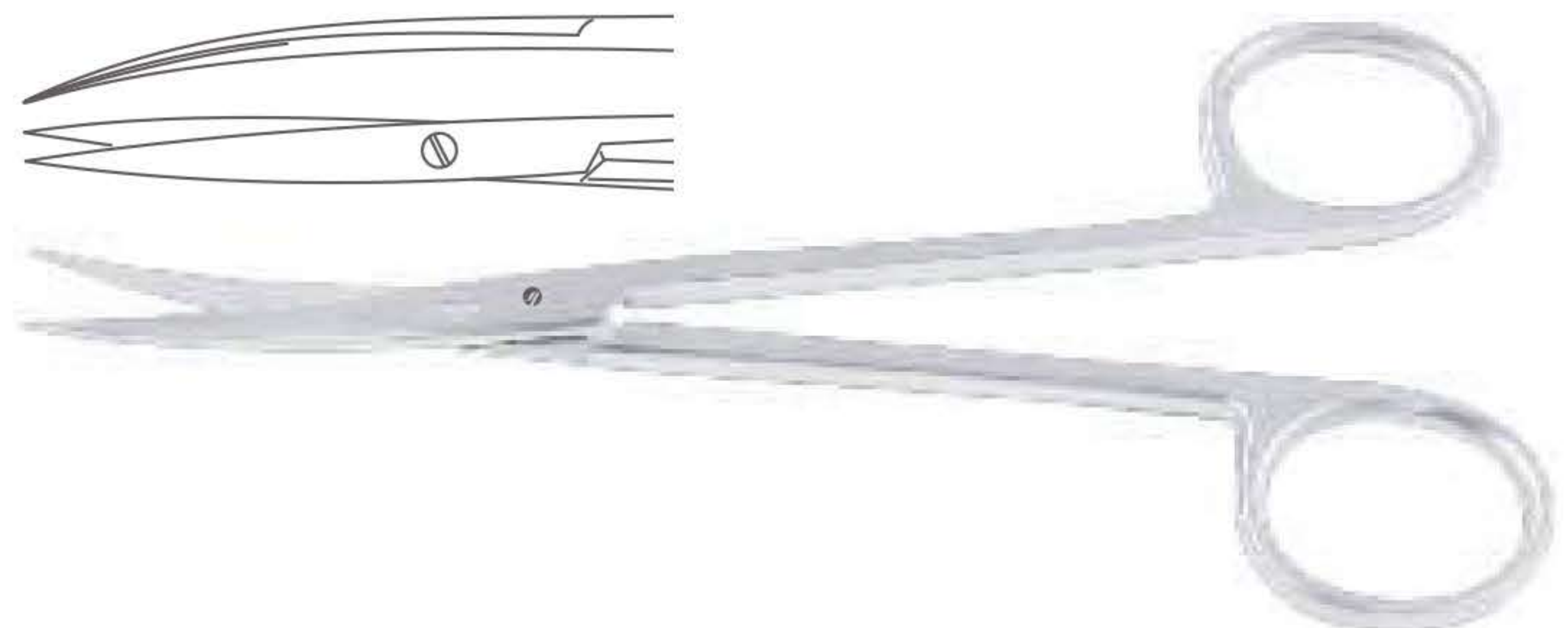

Catalog #	Size
SS-203-16	14.5 cm (5 3/4")

**Metzenbaum-Fine Delicate Dissecting Scissor**  
 Straight, Blunt/Blunt, Slender Pattern

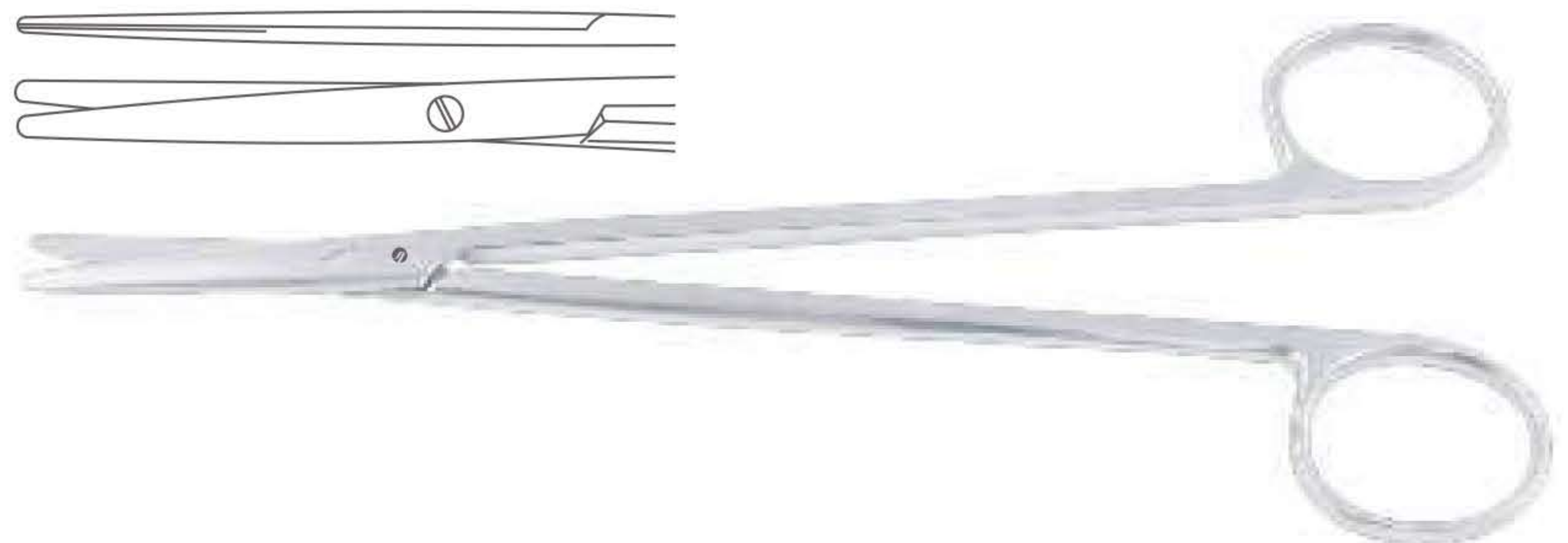

Catalog #	Size
SS-210-18	18 cm (7")
SS-210-20	20 cm (8")
SS-210-23	23 cm (9")

**Metzenbaum-Fine Delicate Dissecting Scissor**  
 Straight, Blunt/Blunt, Slender Pattern

**SUPER Edge™**

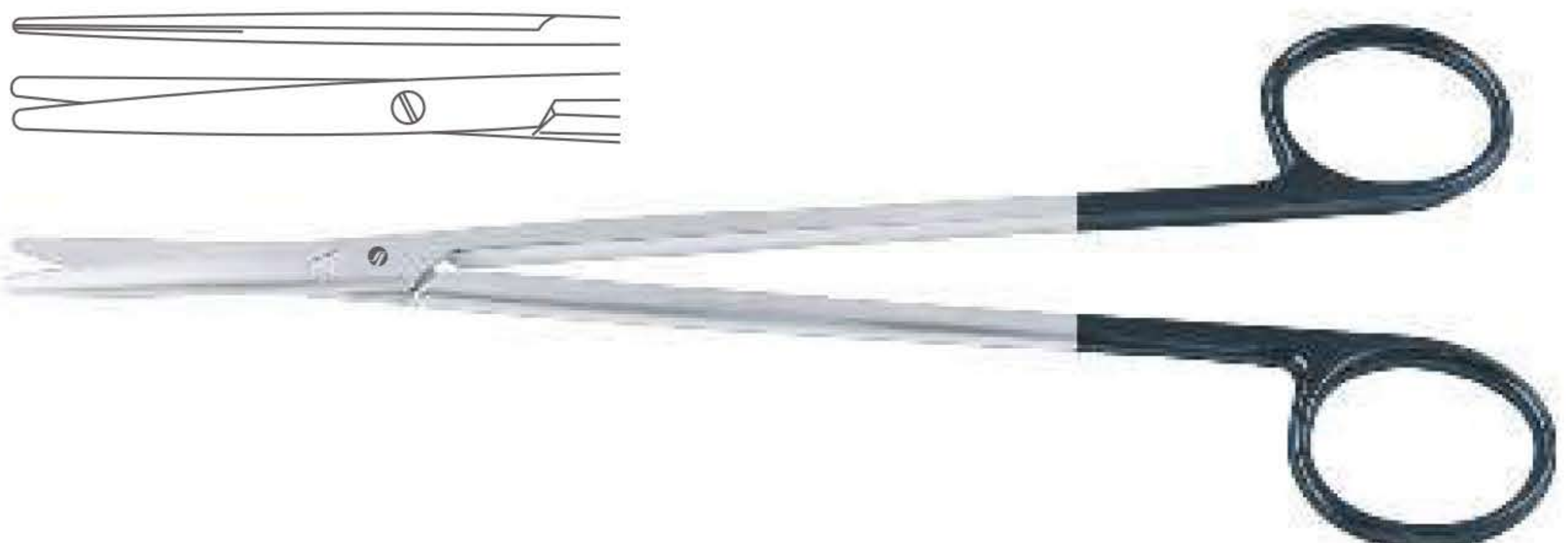

Catalog #	Size
SS-210-18 SC	18 cm (7")
SS-210-20 SC	20 cm (8")
SS-210-23 SC	23 cm (9")

Delicate Dissecting Scissors, Dissecting Scissors  
 Feine Präparierscheren, Präparierscheren  
 Tijeras finas de disección, Tijeras de disección  
 Ciseaux fins à dissection, Ciseaux à dissection  
 Forbici fini per dissezione, Forbici per dissezione

**Metzenbaum-Fine Delicate Dissecting Scissor**  
 Curved, Blunt/Blunt, Slender Pattern

Catalog #	Size
SS-211-18	18 cm (7")
SS-211-20	20 cm (8")
SS-211-23	23 cm (9")

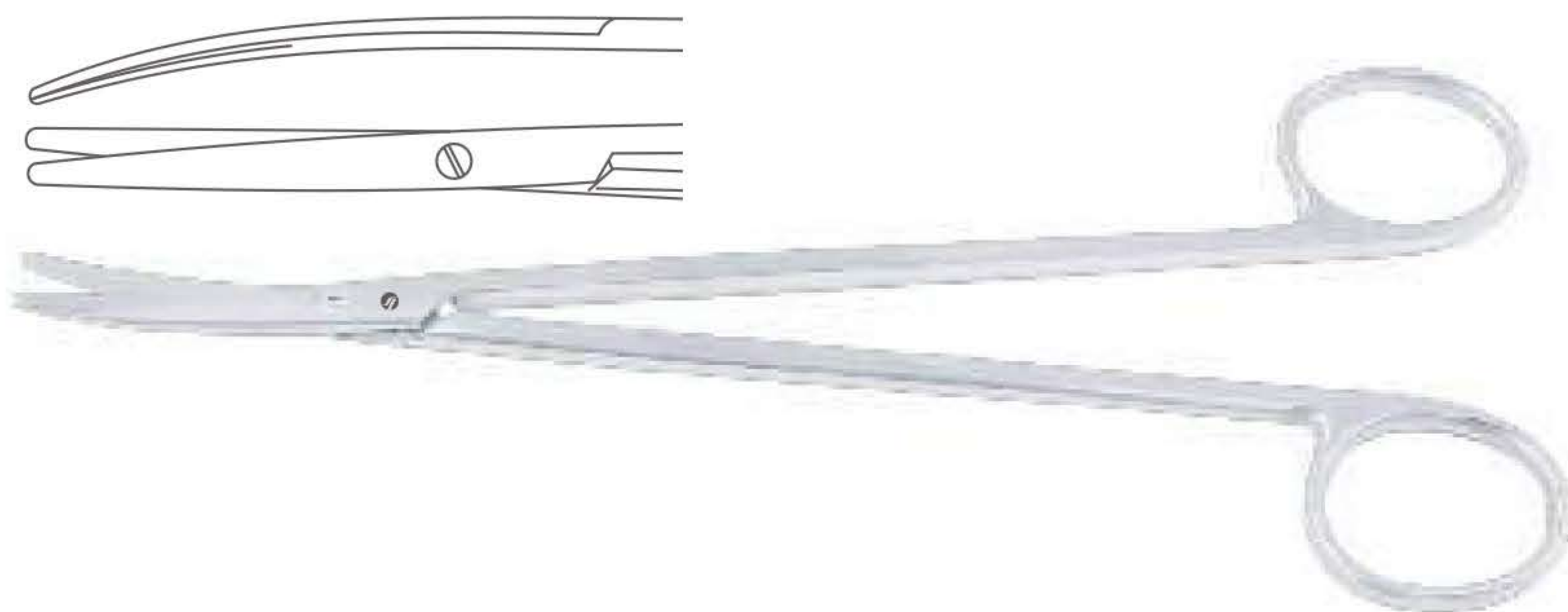

**Metzenbaum-Fine Delicate Dissecting Scissor**  
 Curved, Blunt/Blunt, Slender Pattern

**SUPER Edge™**

Catalog #	Size
SS-211-18 SC	18 cm (7")
SS-211-20 SC	20 cm (8")
SS-211-23 SC	23 cm (9")

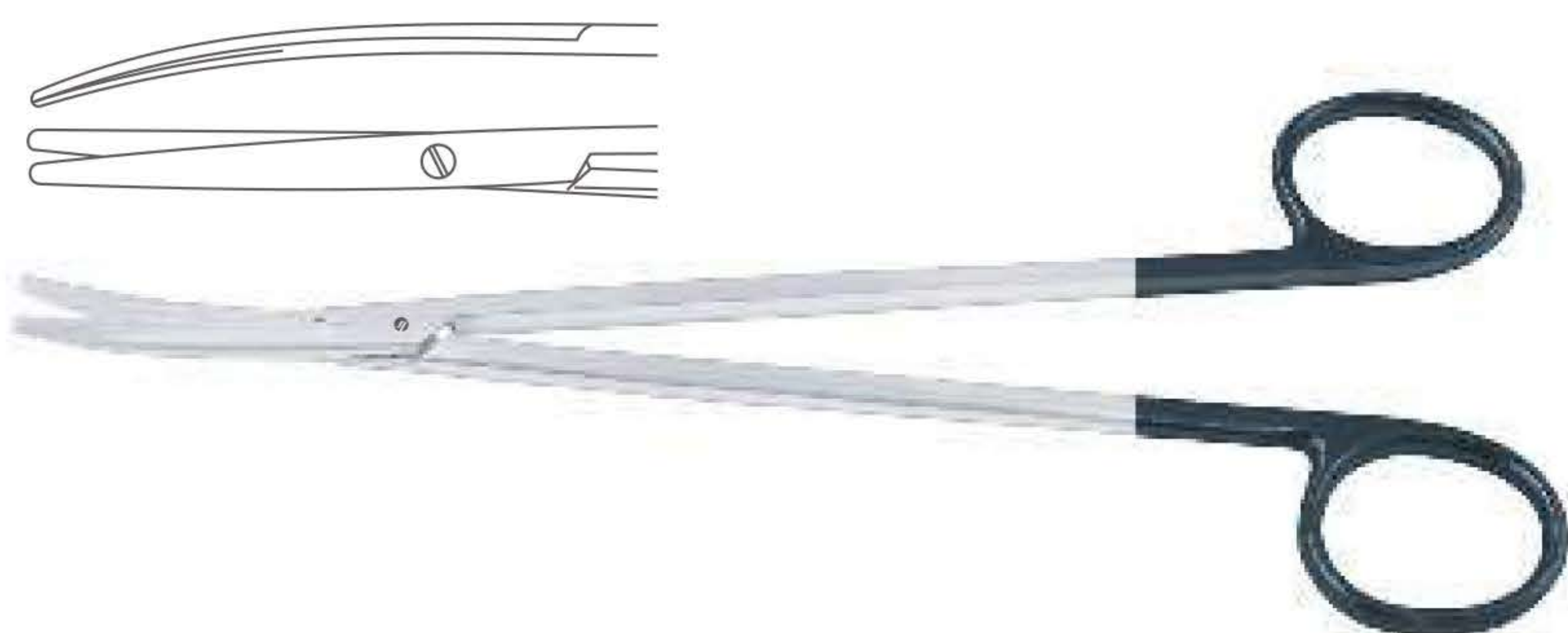

**Metzenbaum-Fine Delicate Dissecting Scissor**  
 Straight, Sharp/Sharp, Slender Pattern

Catalog #	Size
SS-214-18	18 cm (7")
SS-214-20	20 cm (8")
SS-214-23	23 cm (9")



**Metzenbaum-Fine Delicate Dissecting Scissor**  
 Straight, Sharp/Sharp, Slender Pattern

**SUPER Edge™**

Catalog #	Size
SS-214-18 SC	18 cm (7")
SS-214-20 SC	20 cm (8")
SS-214-23 SC	23 cm (9")



Delicate Dissecting Scissors, Dissecting Scissors  
 Feine Präparierscheren, Präparierscheren  
 Tijeras finas de disección, Tijeras de disección  
 Ciseaux fins à dissection, Ciseaux à dissection  
 Forbici fini per dissezione, Forbici per dissezione

**Metzenbaum-Fine Delicate Dissecting Scissor**  
 Curved, Sharp/Sharp, Slender Pattern

Catalog #	Size
SS-215-18	18 cm (7")
SS-215-20	20 cm (8")
SS-215-23	23 cm (9")



**Metzenbaum-Fine Delicate Dissecting Scissor**  
 Curved, Sharp/Sharp, Slender Pattern

**SUPER Edge™**

Catalog #	Size
SS-215-18 SC	18 cm (7")
SS-215-20 SC	20 cm (8")
SS-215-23 SC	23 cm (9")



**Metzenbaum-Fine Delicate Dissecting Scissor**  
 Curved, S Shaped

Catalog #	Size
SS-219-18	18 cm (7")
SS-219-20	20 cm (8")
SS-219-23	23 cm (9")

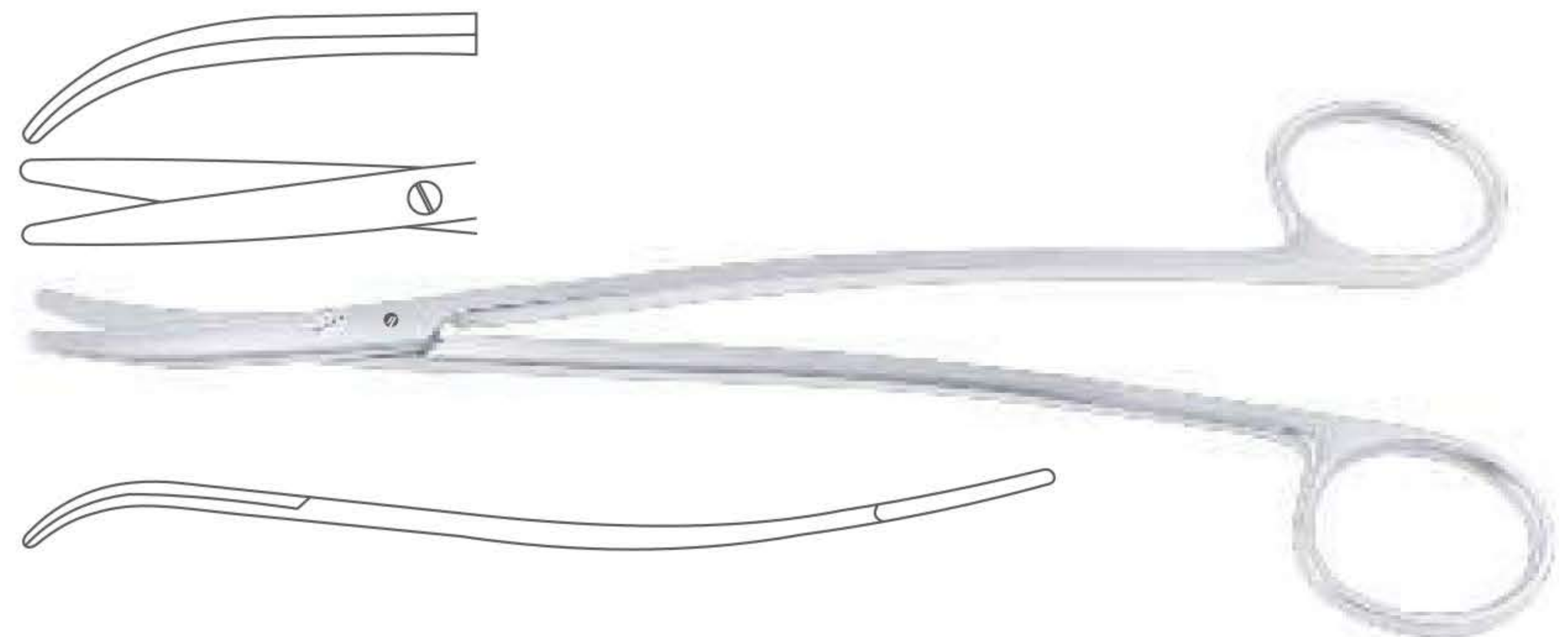

**Salzer Cleft Palate Dissecting Scissor**  
 Curved, Fine Pattern

Catalog #	Size
SS-223-12	12.5 cm (5")
SS-223-18	18 cm (7")



Dissecting Scissors, Face-lift Scissors  
 Präparierscheren, Face-lift-Scheren  
 Tijeras de disección, Tijeras para Face-Lift  
 Ciseaux à dissection, Ciseaux pour Face-lift  
 Forbici per dissezione, Forbici per Face-lift

**Sanvenero Dissecting Scissor**  
 Straight



Catalog #	Size
SS-226-14	14 cm (5 1/2")

**Sanvenero Dissecting Scissor**  
 Curved

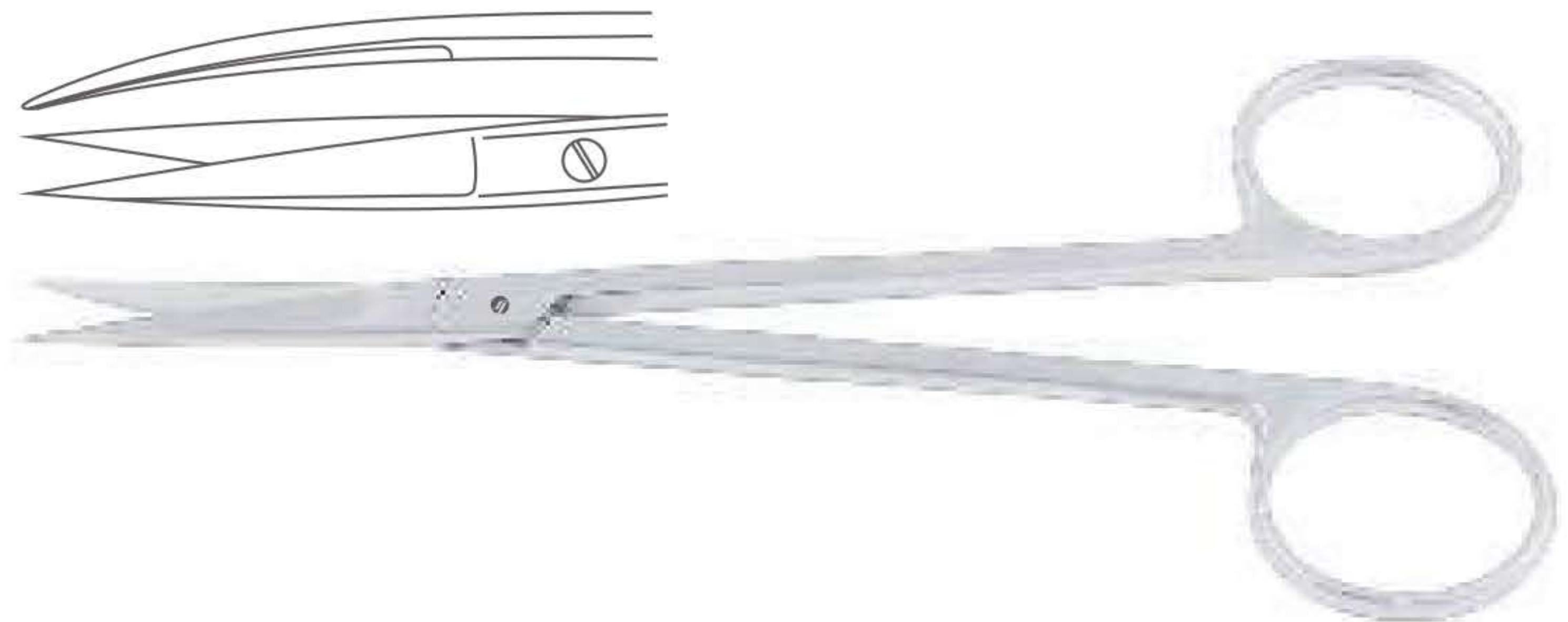

Catalog #	Size
SS-227-14	14 cm (5 1/2")

**Tenotomy Scissor**  
 Straight

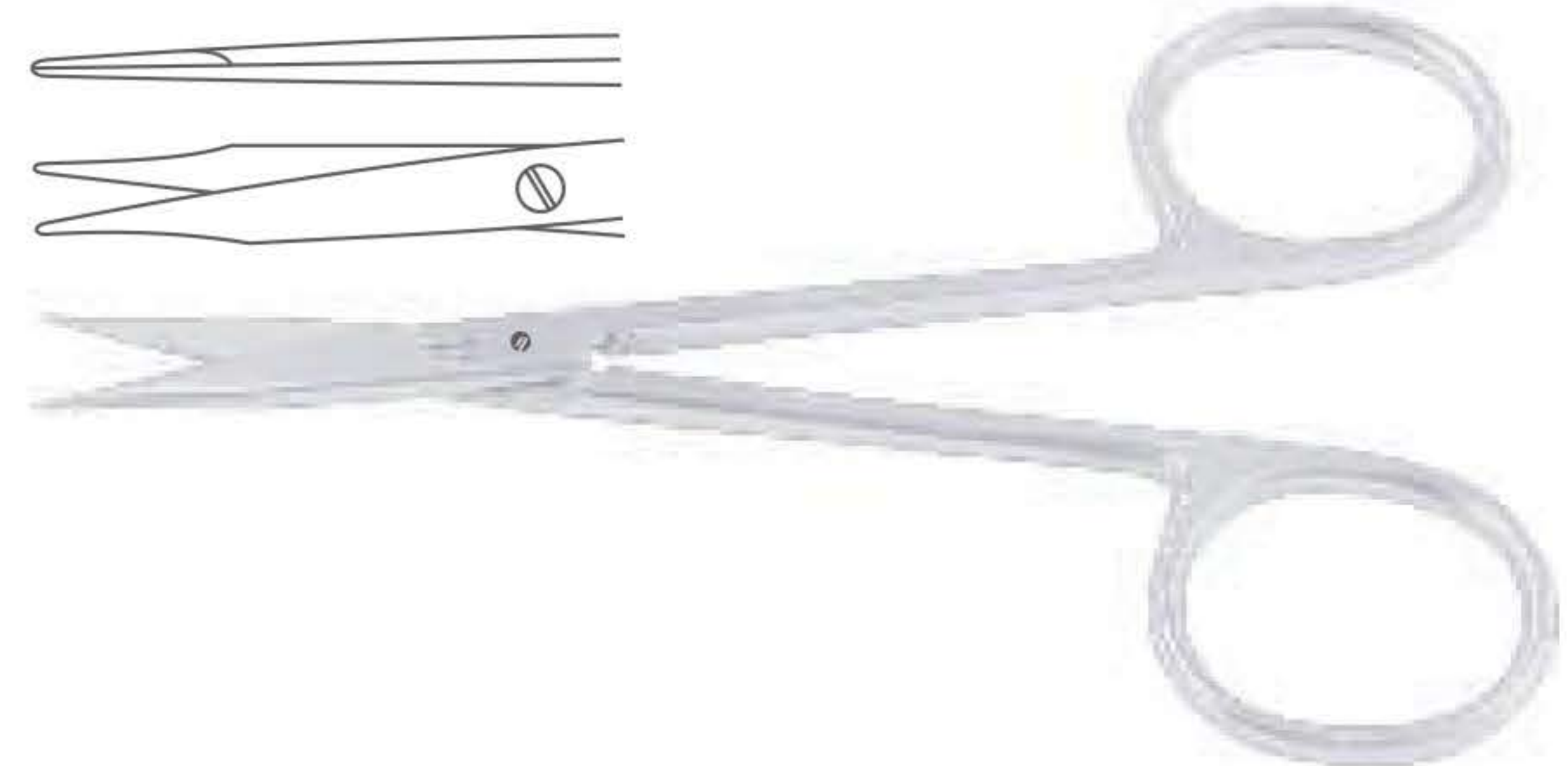

Catalog #	Size
SS-230-11	11.5 cm (4 1/2")

**Tenotomy Scissor**  
 Curved

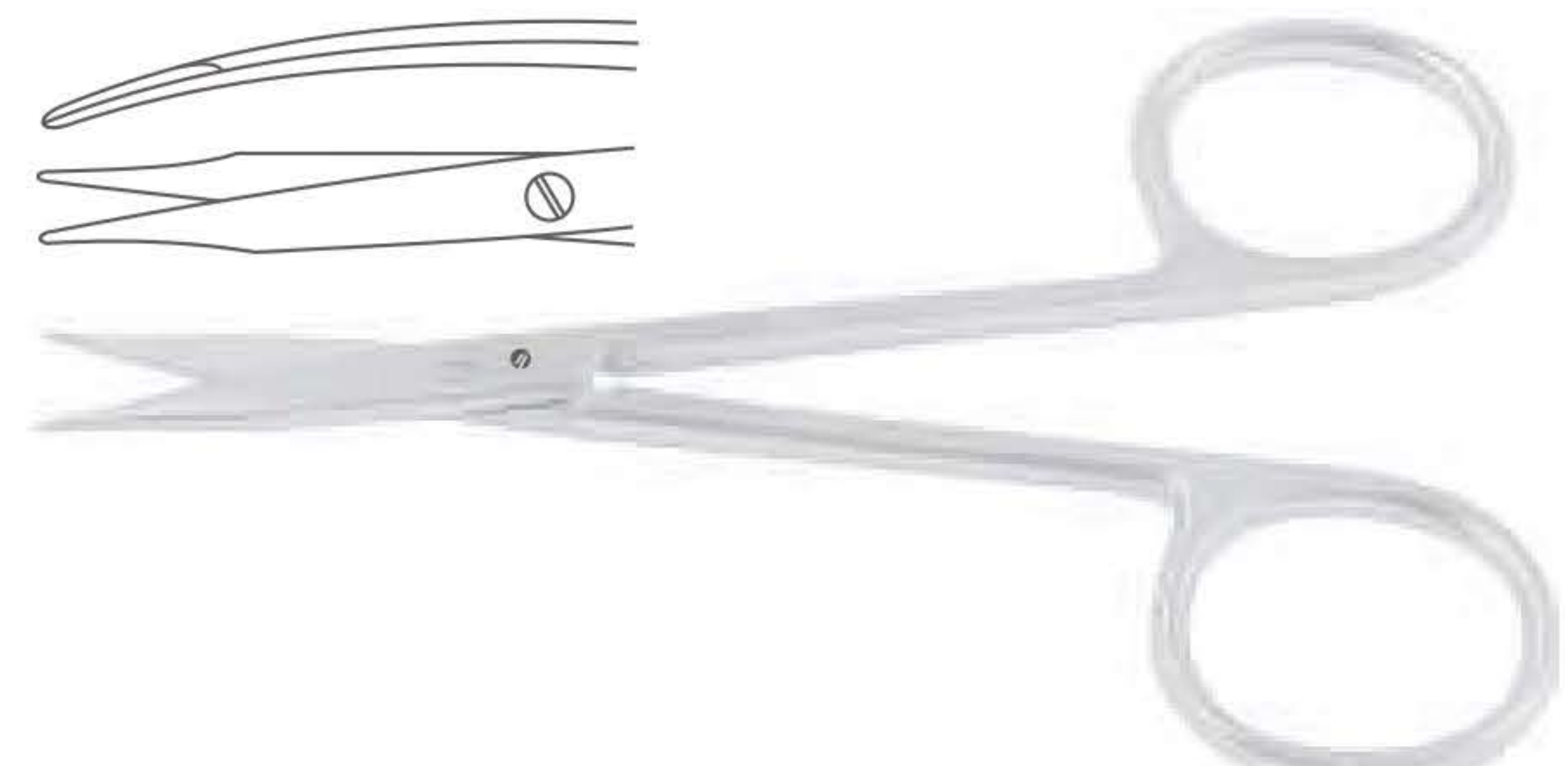

Catalog #	Size
SS-231-11	11.5 cm (4 1/2")

**Peck-Joseph Face-Lift Scissor**  
 Straight, Sharp/Sharp

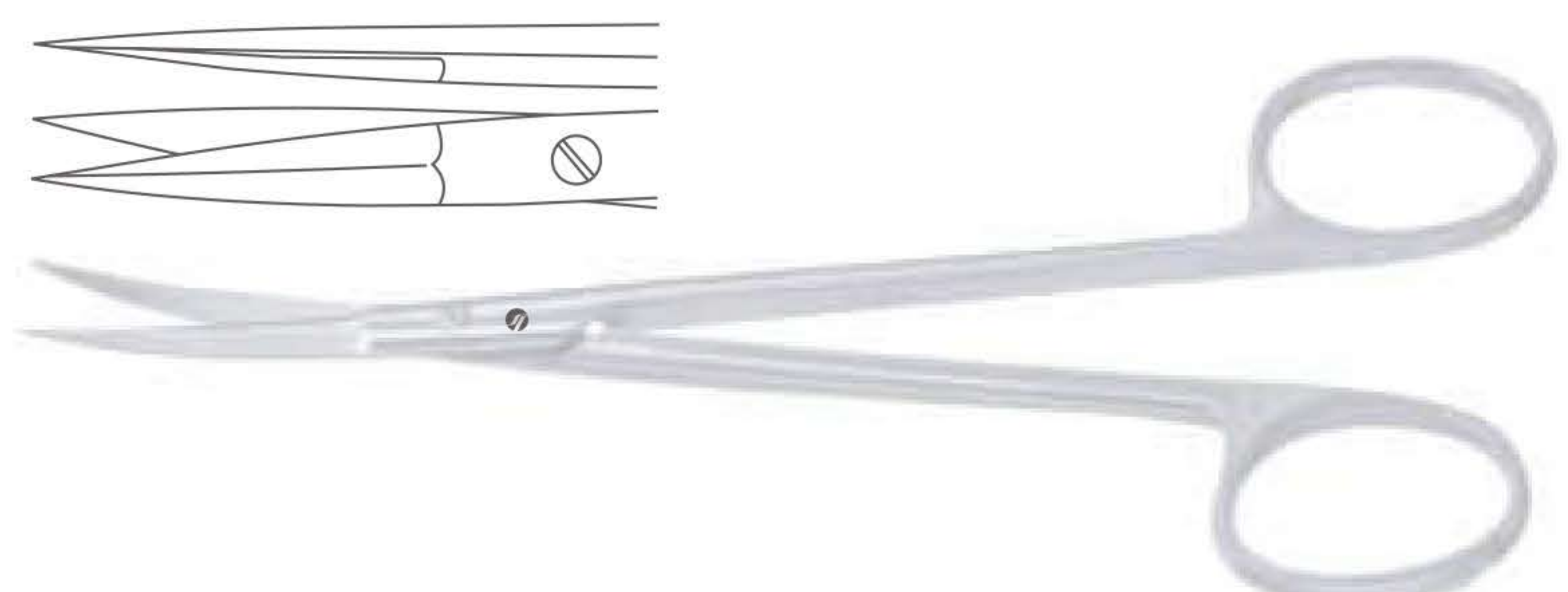

Catalog #	Size
SS-236-14	14.5 cm (5 3/4")

Face-lift Scissors, Dissecting Scissors  
 Face-lift-Scheren, Präparierscheren  
 Tijeras para Face-Lift, Tijeras de disección  
 Ciseaux pour Face-lift, Ciseaux à dissection  
 Forbici per Face-lift, Forbici per dissezione

**Peck-Joseph Face-Lift Scissor**  
 Curved, Sharp/Sharp

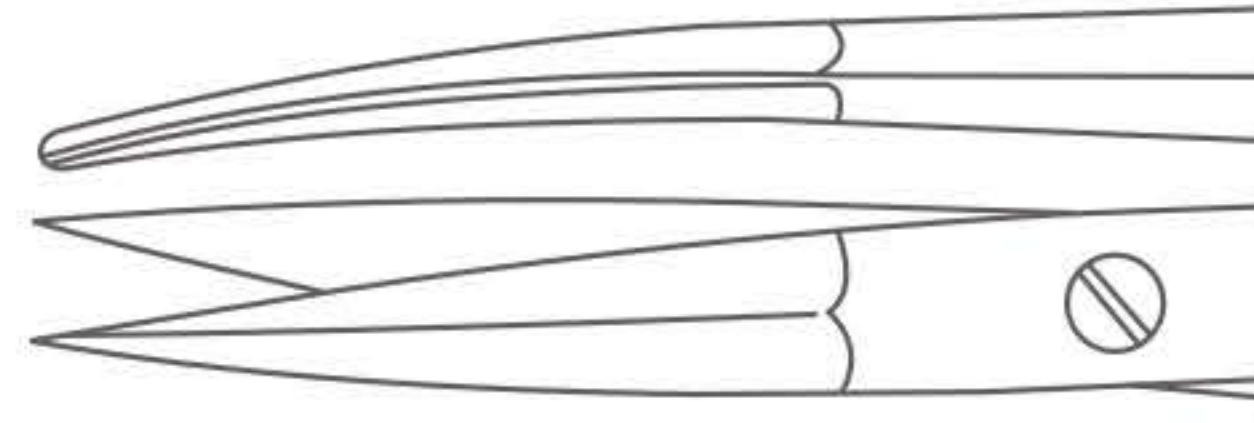

Catalog #	Size
SS-237-14	14.5 cm (5 3/4")

**Peck-Joseph Face-Lift Scissor**  
 Straight, Blunt/Blunt

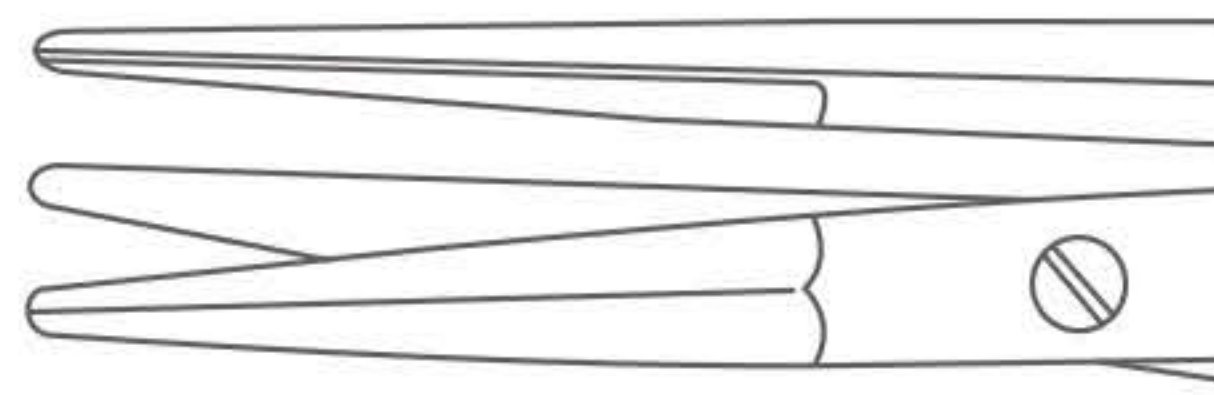

Catalog #	Size
SS-238-14	14.5 cm (5 3/4")

**Peck-Joseph Face-Lift Scissor**  
 Curved, Blunt/Blunt

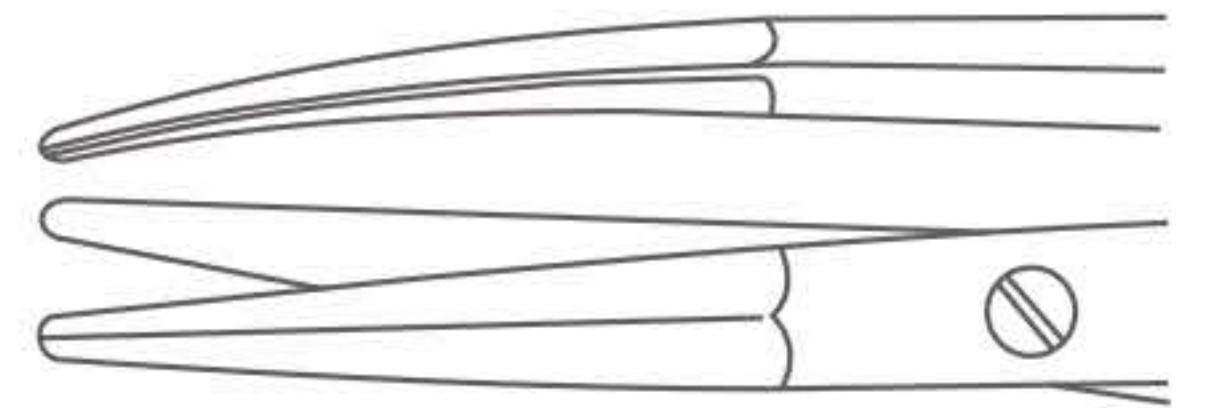

Catalog #	Size
SS-239-14	14.5 cm (5 3/4")

**Shea Vein Graft Scissor**  
 Curved

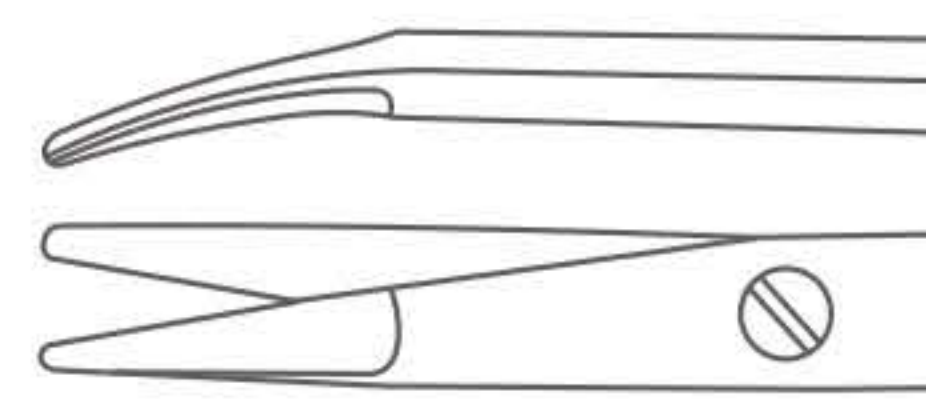

Catalog #	Size
SS-241-12	12 cm (4 3/4")

**Ragnell (Kilner) Dissecting Scissor**  
 Curved

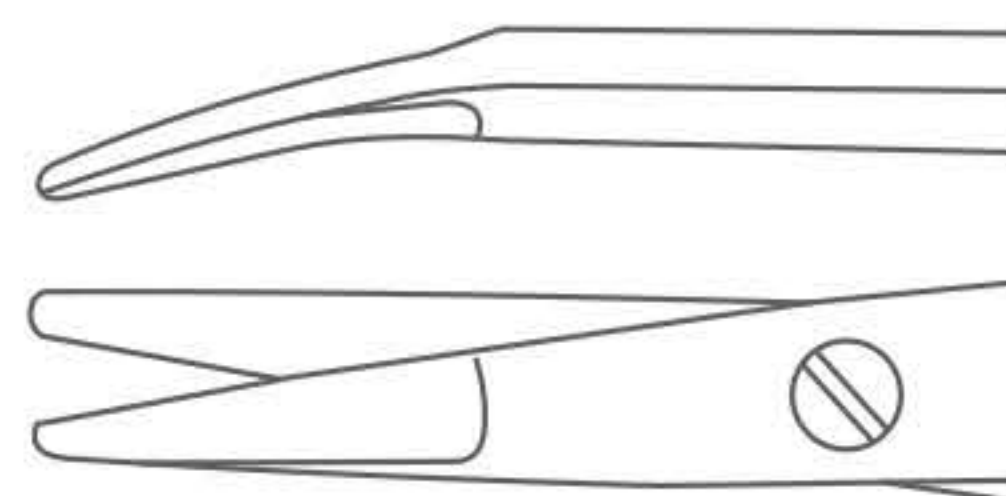

Catalog #	Size
SS-243-12	12 cm (4 3/4")
SS-243-15	15 cm (6")
SS-243-18	18 cm (7")

Dissecting Scissors  
 Präparierscheren  
 Tijeras de disección  
 Ciseaux à dissection  
 Forbici per dissezione

**Nerve Dissecting Scissor**  
 Curved, Semi Sharp

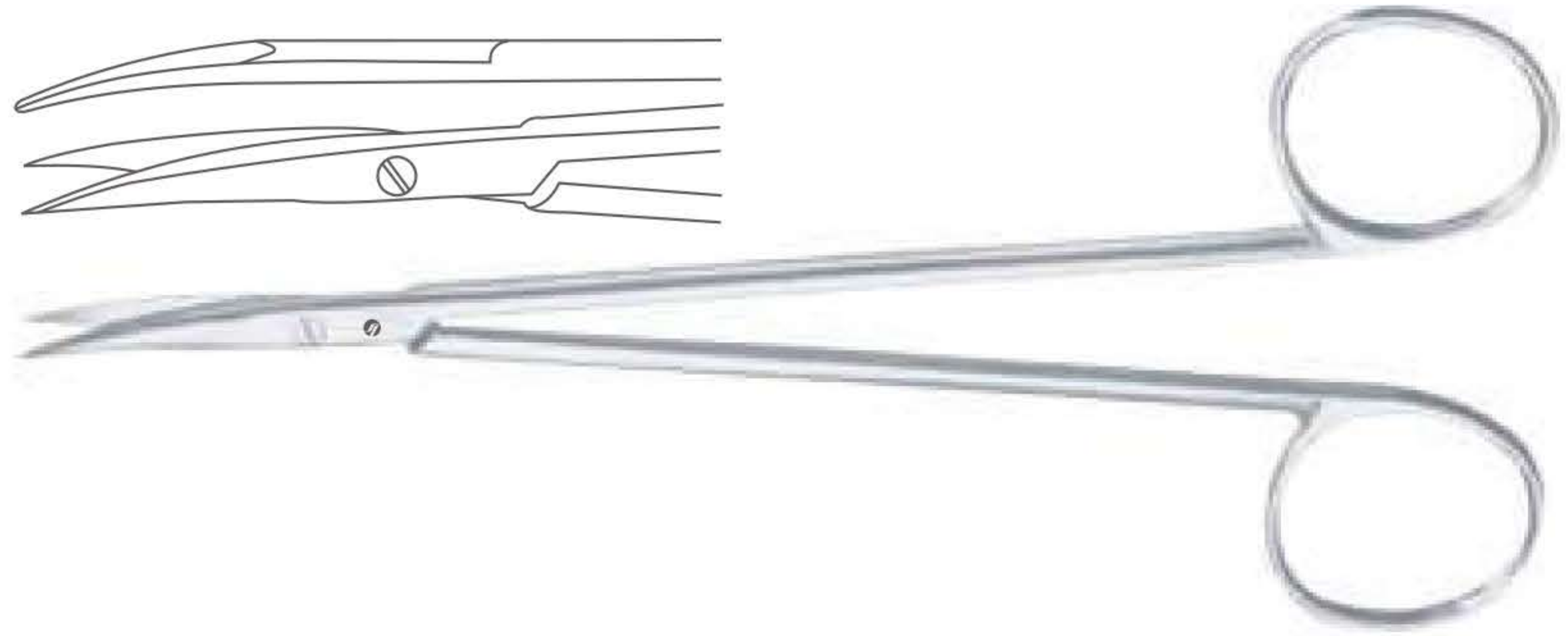

Catalog #	Size
SS-245-15	15 cm (6")

**Dissecting Scissor**  
 Straight

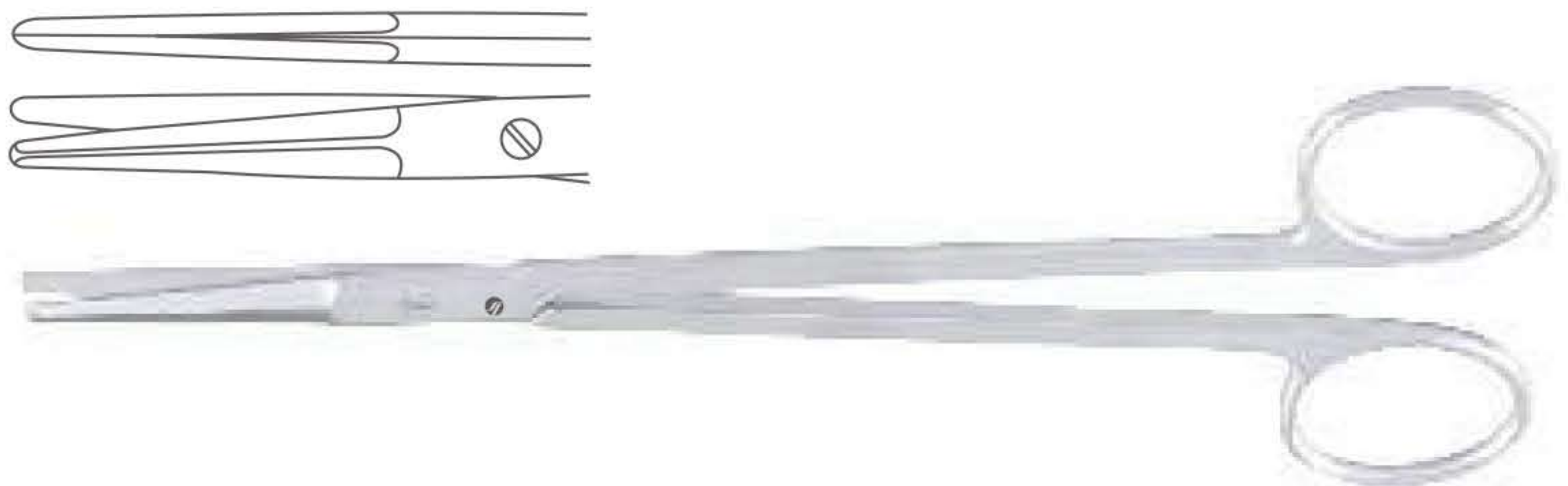

Catalog #	Size
SS-248-14	14.5 cm (5 3/4")

**Dissecting Scissor**  
 Curved



Catalog #	Size
SS-249-14	14.5 cm (5 3/4")

**Reynolds Dissecting Scissor**  
 Straight

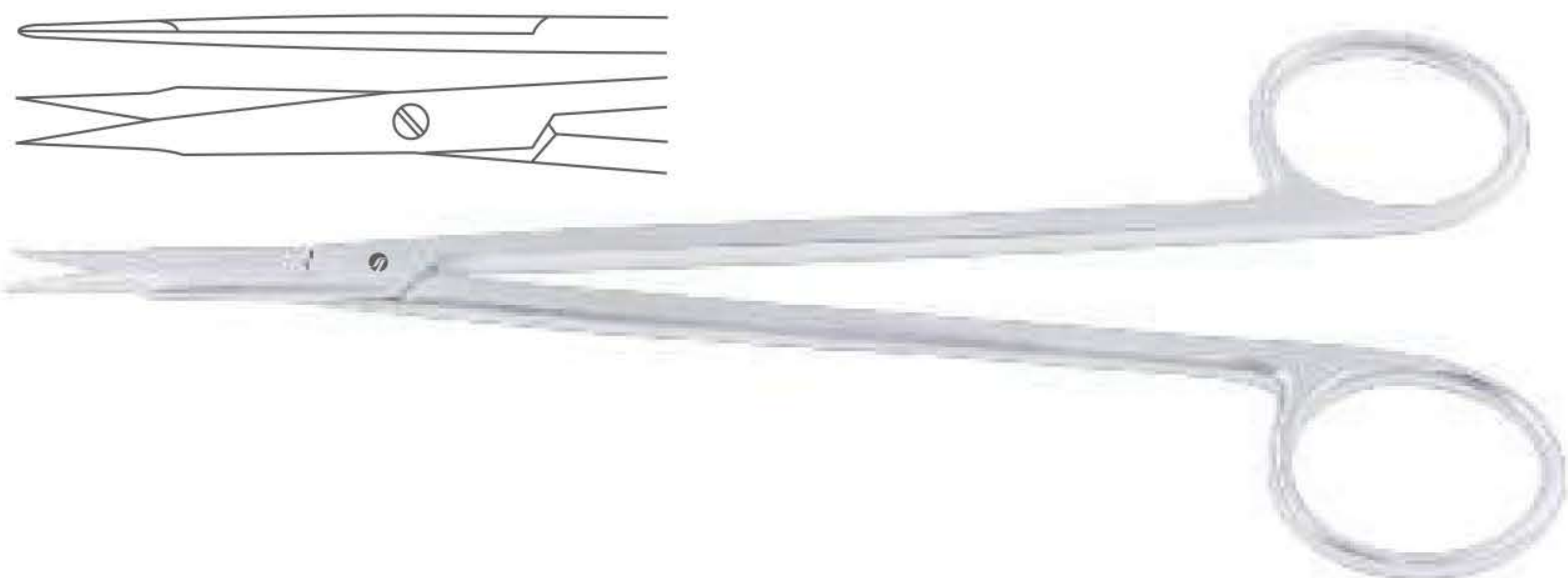

Catalog #	Size
SS-250-15	15.5 cm (6")
SS-250-18	18 cm (7")

**Reynolds Dissecting Scissor**  
 Straight

**SUPER** Edge™

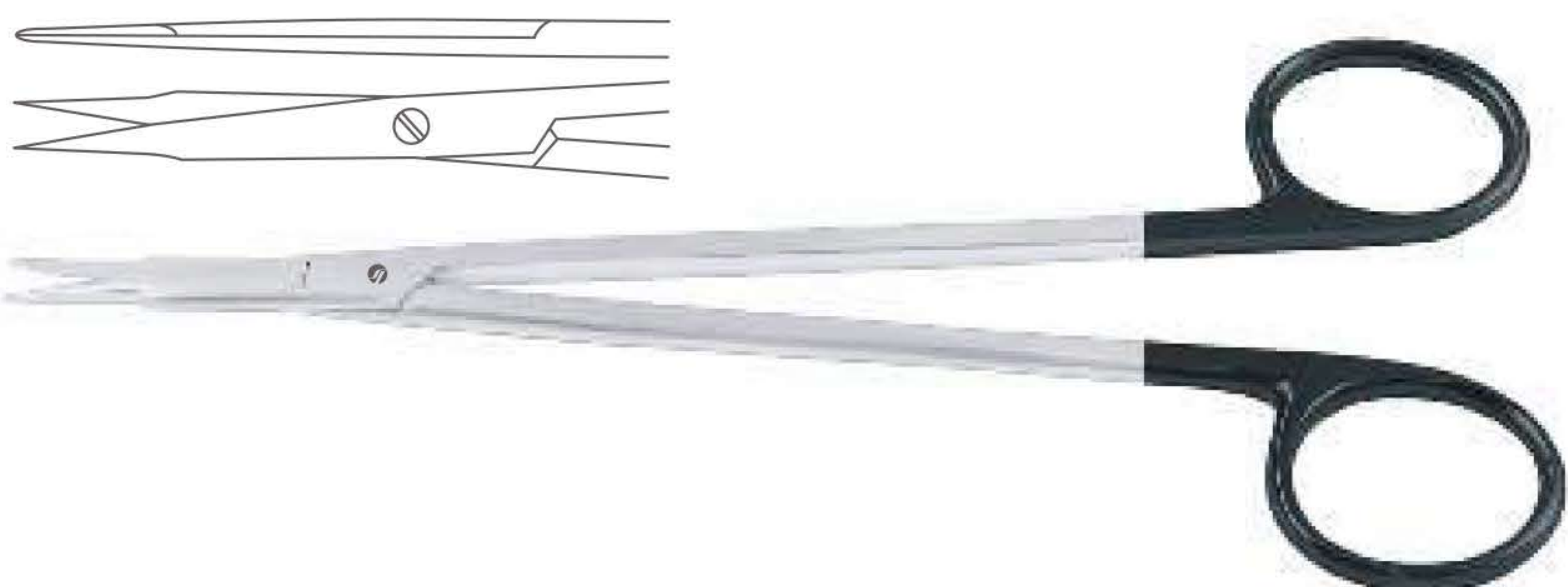

Catalog #	Size
SS-250-15 SC	15.5 cm (6")
SS-250-18 SC	18 cm (7")

Dissecting Scissors  
 Präparierscheren  
 Tijeras de disección  
 Ciseaux à dissection  
 Forbici per dissezione

**Reynolds Dissecting Scissor**  
 Curved

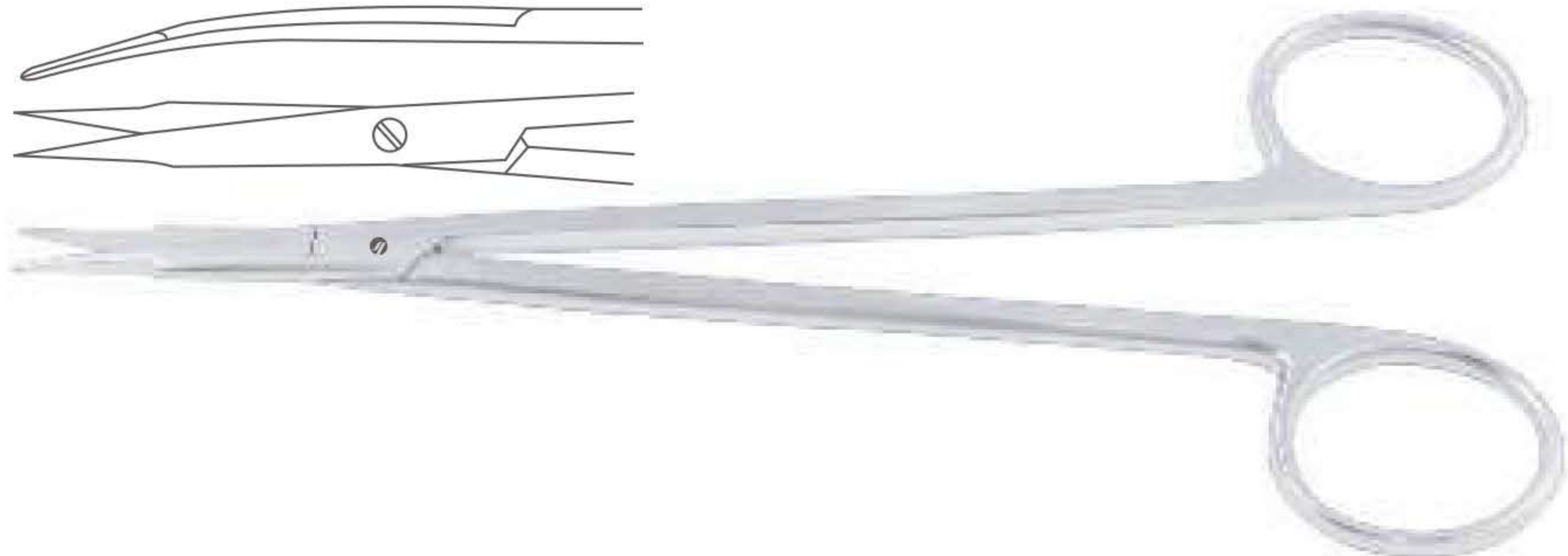

Catalog #	Size
SS-251-15	15.5 cm (6")
SS-251-18	18 cm (7")

**Reynolds Dissecting Scissor**  
 Curved



Catalog #	Size
SS-251-15 SC	15.5 cm (6")
SS-251-18 SC	18 cm (7")

**Jameson Dissecting Scissor**  
 Curved

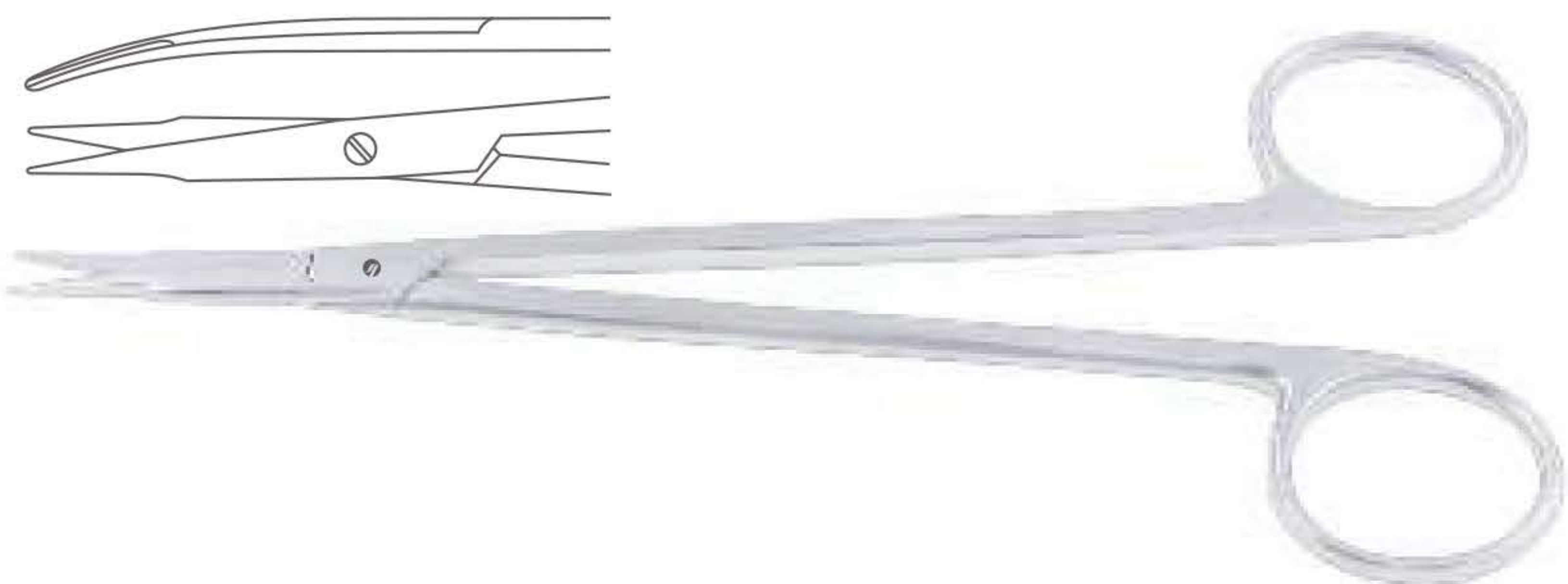

Catalog #	Size
SS-253-15	15.5 cm (6")

**Jameson Dissecting Scissor**  
 Curved

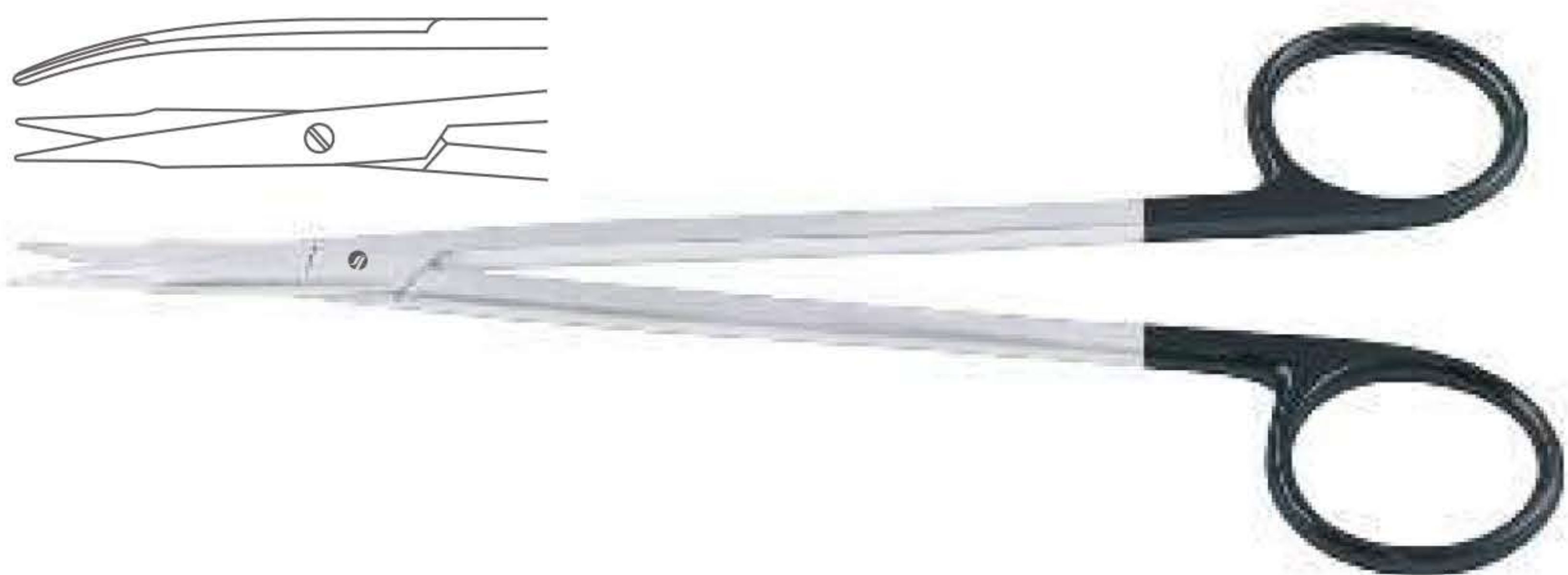

**SUPER Edge™**

Catalog #	Size
SS-253-15 SC	15.5 cm (6")

**Jameson-Werber Dissecting Scissor**  
 Curved

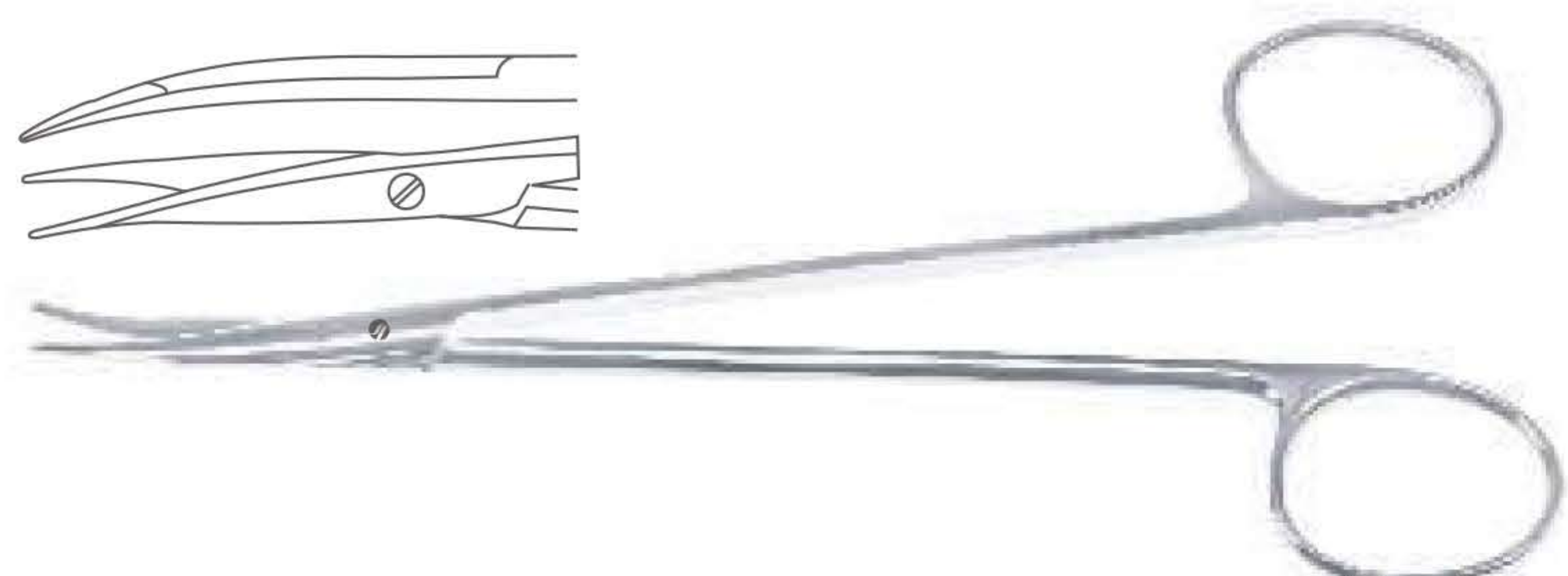

Catalog #	Size
SS-257-13	13 cm (5")

Dissecting Scissors, Vascular Scissors  
 Präparierscheren, Gefäßscheren  
 Tijeras de disección, Tijeras vasculares  
 Ciseaux à dissection, Ciseaux vasculaires  
 Forbici per dissezione, Forbici vascolari

**Potts Dissecting Scissor**  
 Curved

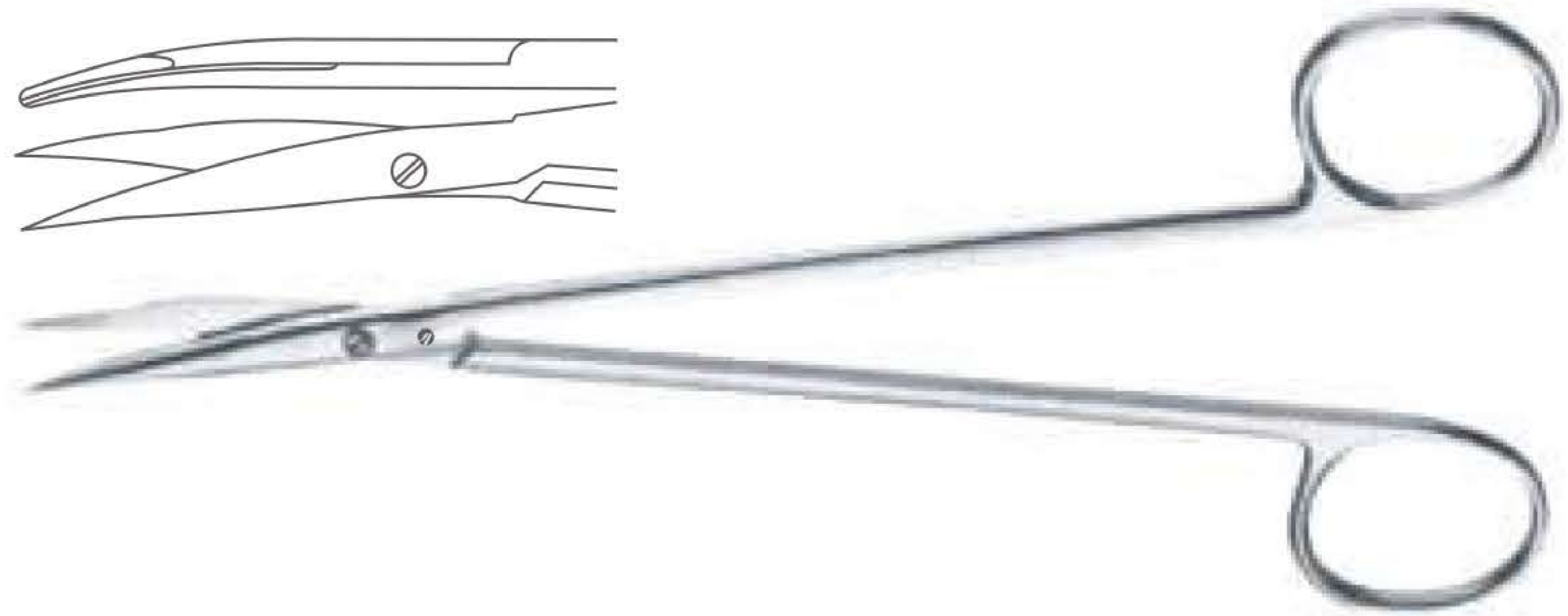

Catalog #	Size
SS-259-18	18 cm (7")

**DeBakey Arteriotomy Scissor**  
 Curved

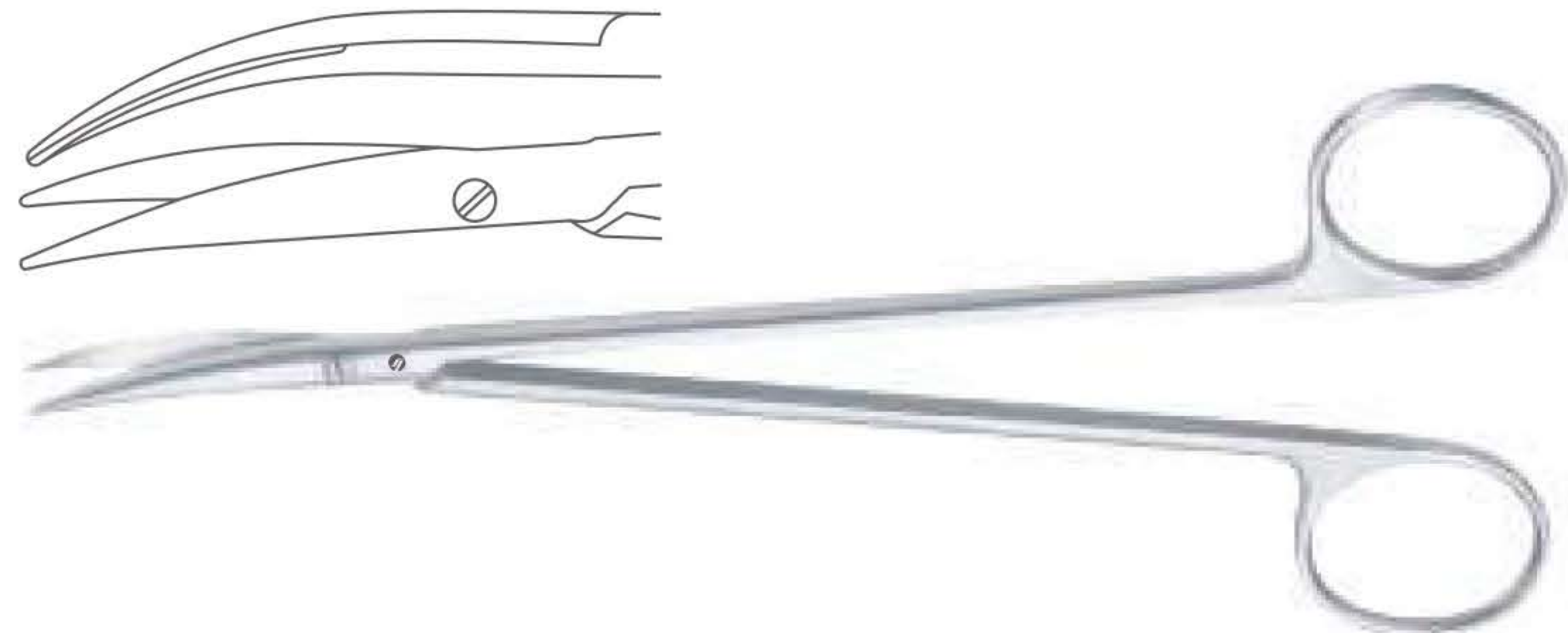

Catalog #	Size
SS-261-17	17.5 cm (7")

**Vascular Scissor**  
 Straight

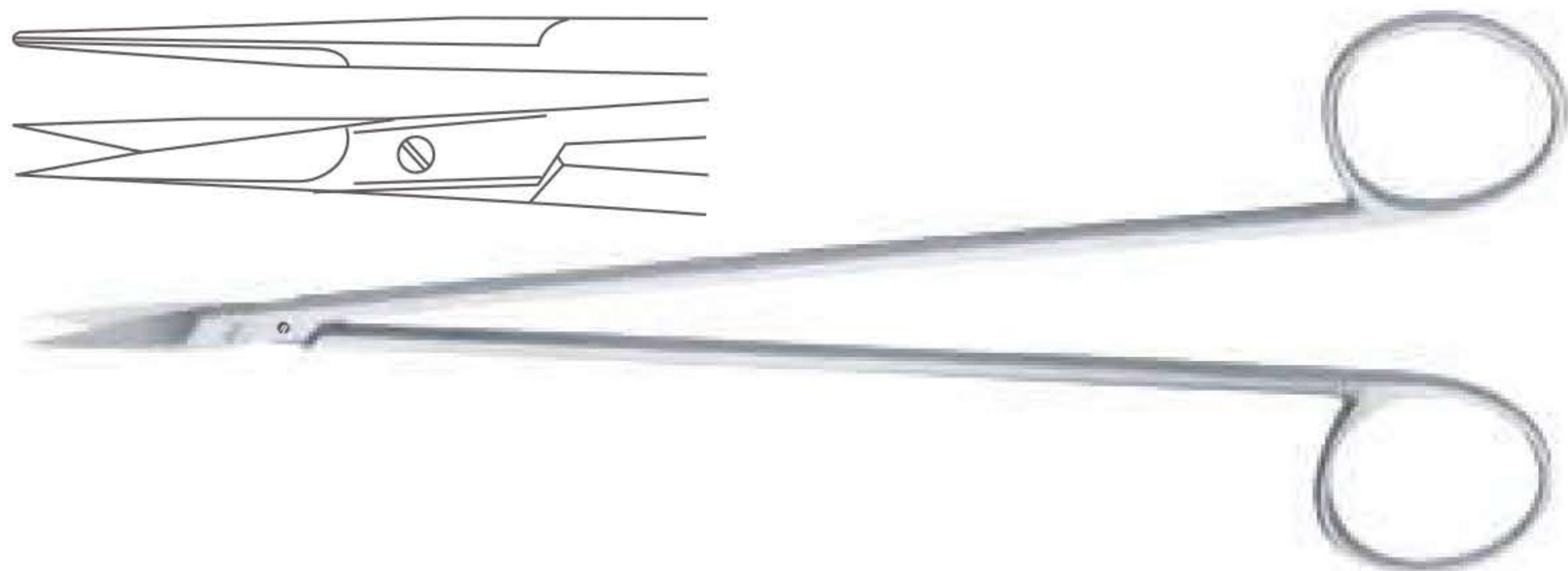

Catalog #	Size
SS-264-19	19 cm (7 1/2")

**Vascular Scissor**  
 Curved

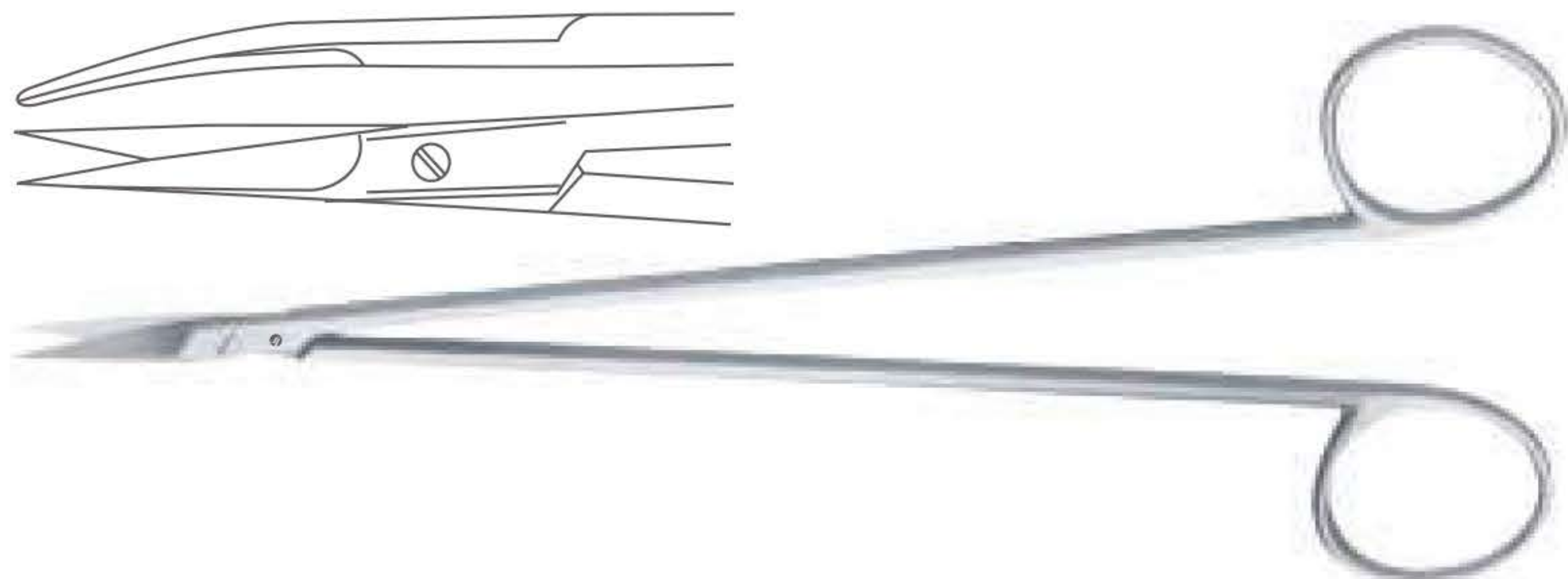

Catalog #	Size
SS-265-19	19 cm (7 1/2")

**Satinsky Thoracic Scissor**  
 Curved

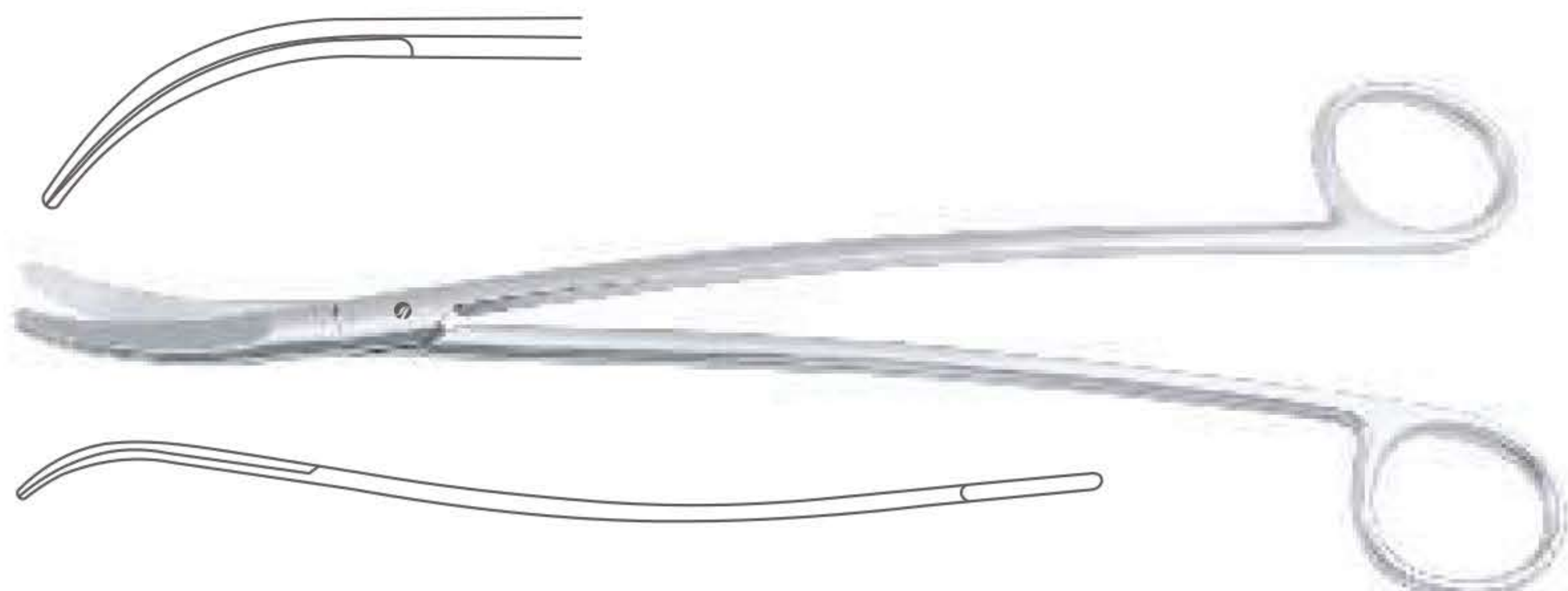

Catalog #	Size
SS-267-24	25.5 cm (10")

Vascular Scissors  
 Gefäßscheren  
 Tijeras vasculares  
 Ciseaux vasculaires  
 Forbici vascolari

**Diethrich-Salyer Cleft Palate Dissecting Scissor**  
 Angled

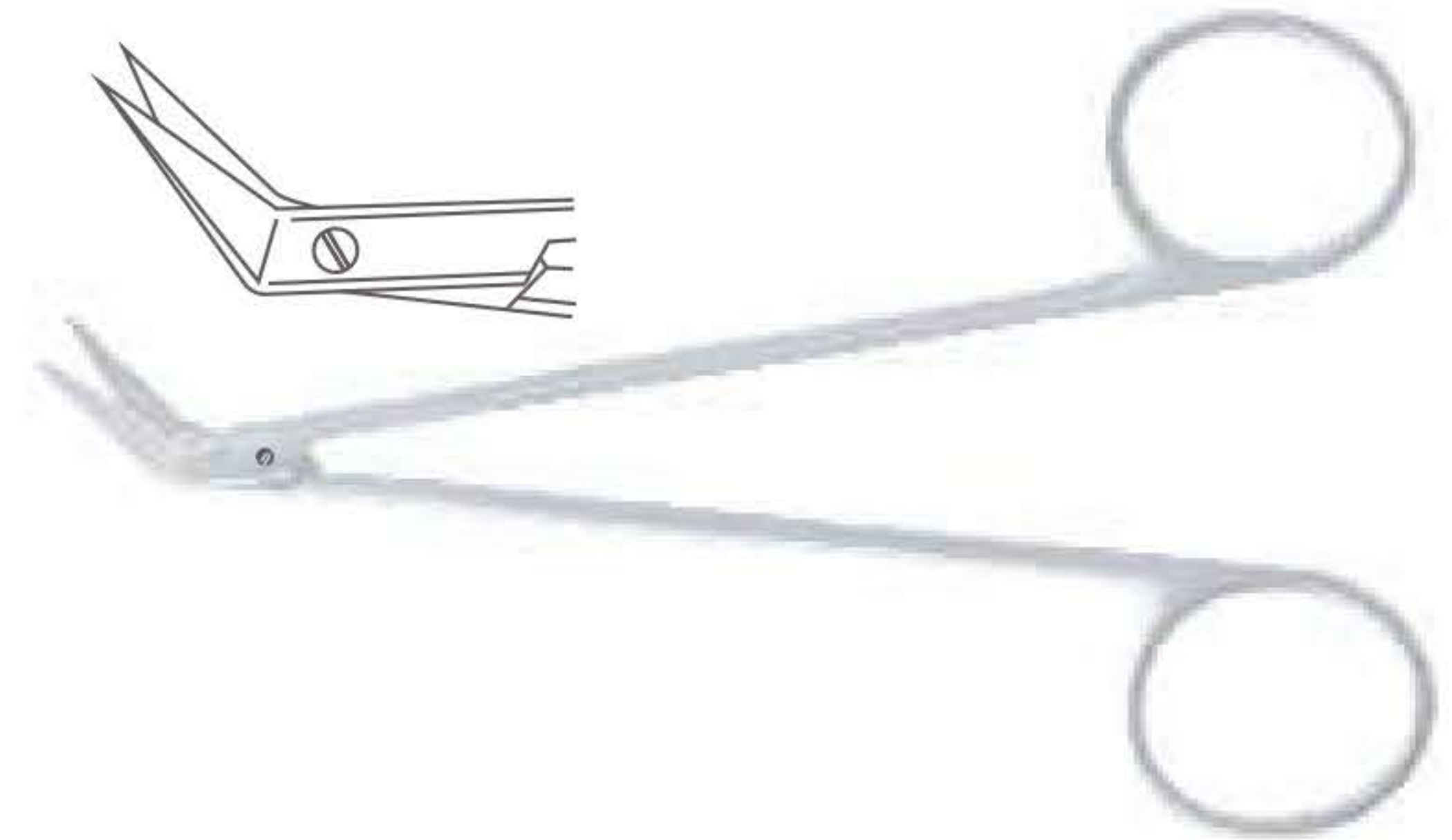

Catalog #	Size
SS-269-12	12 cm (4 3/4")

**Diethrich Vascular Scissor**  
 Angled 125°, With Guide



Catalog #	Size
SS-275-00	17.5 cm (7")

**DeBakey Vascular Scissor**  
 Angled 45°



Catalog #	Size
SS-277-45	16.5 cm (6 1/2")

**DeBakey Vascular Scissor**  
 Angled 60°



Catalog #	Size
SS-277-60	16cm (6 1/4")

**Potts-Smith Vascular Scissor**  
 Angled 60°, With Probe Tip



Catalog #	Size
SS-279-19	18 cm (7")

Vascular Scissors  
 Gefäßscheren  
 Tijeras vasculares  
 Ciseaux vasculaires  
 Forbici vascolari

**Potts-Smith Vascular Scissor**  
 Angled 25°

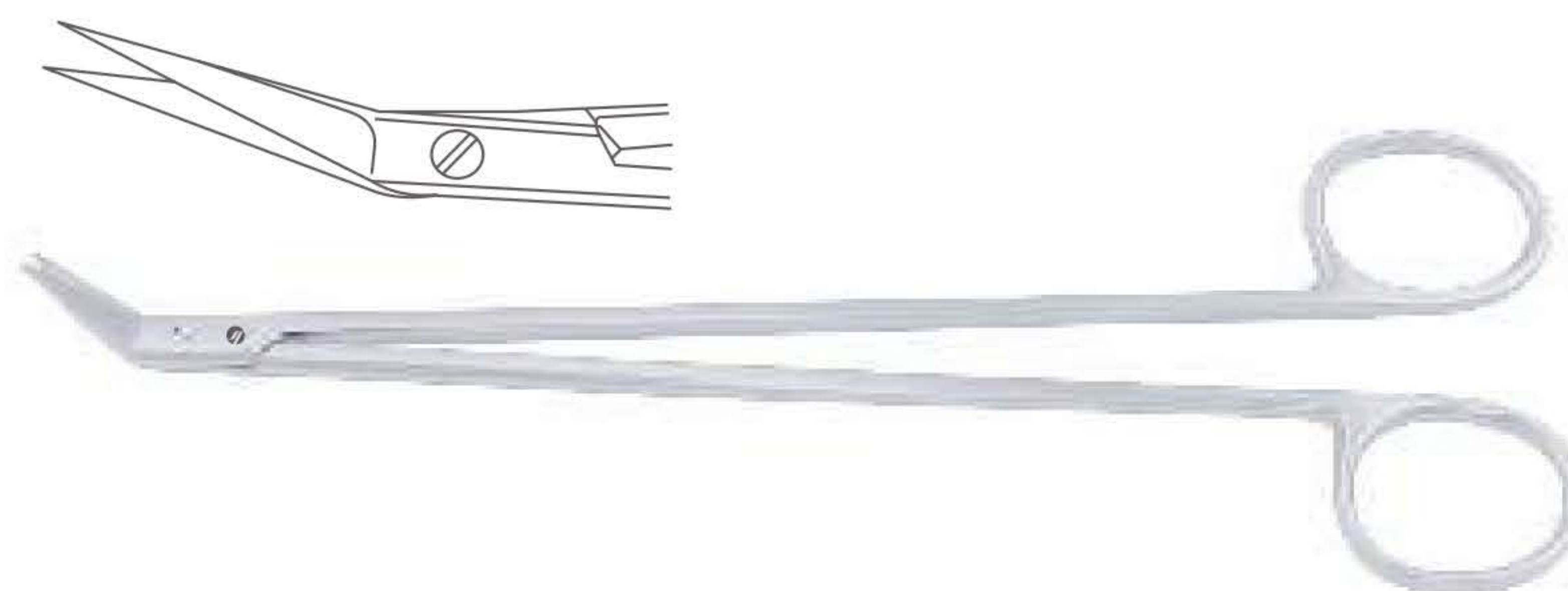

Catalog #	Size
SS-281-25	18 cm (7")

**Potts-Smith Vascular Scissor**  
 Angled 25°

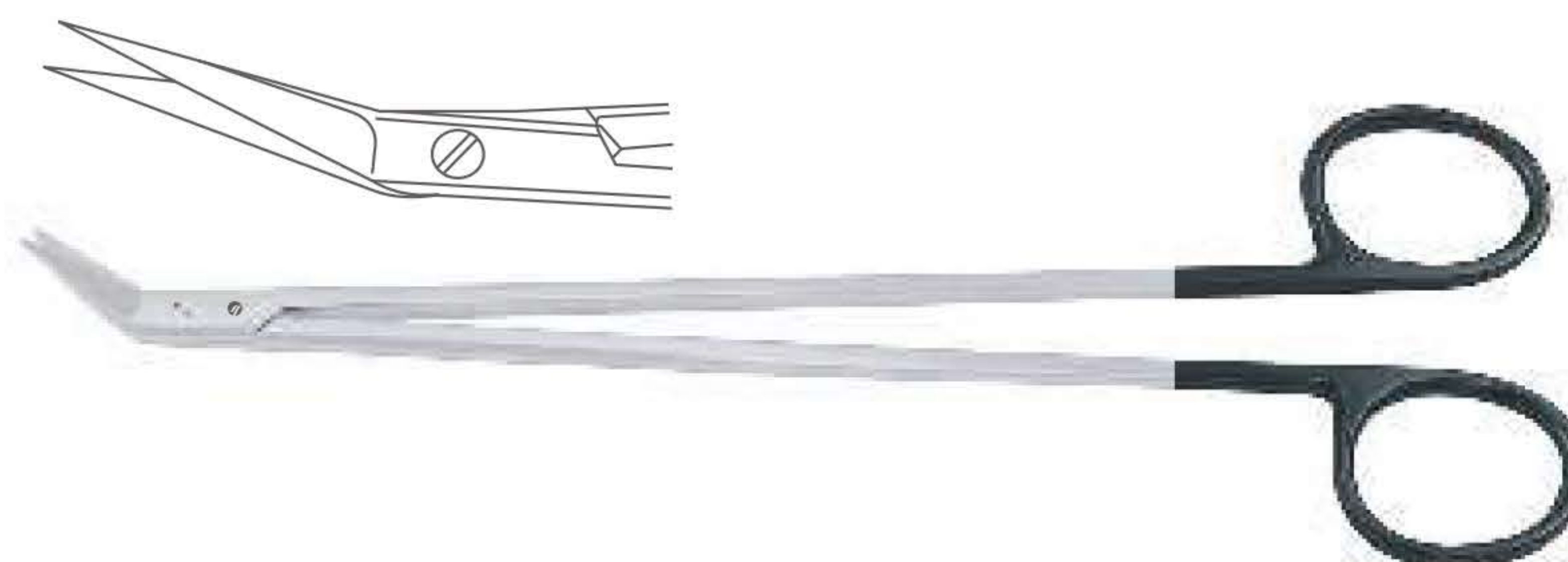

Catalog #	Size
SS-281-25 SC	18 cm (7")

**Potts-Smith Vascular Scissor**  
 Angled 45°



Catalog #	Size
SS-281-45	18.5 cm (7 1/4")

**Potts-Smith Vascular Scissor**  
 Angled 45°



Catalog #	Size
SS-281-45 SC	18.5 cm (7 1/4")

**Potts-Smith Vascular Scissor**  
 Angled 60°



Catalog #	Size
SS-281-60	18 cm (7")

Vascular Scissors  
 Gefäßscheren  
 Tijeras vasculares  
 Ciseaux vasculaires  
 Forbici vascolari

**Potts-Smith Vascular Scissor**  
 Angled 60°

Catalog #	Size
SS-281-60 SC	18 cm (7")



**Potts-Smith Vascular Scissor**  
 Angled on Flat

Catalog #	Size
SS-283-19	18.5 cm (7 1/4")

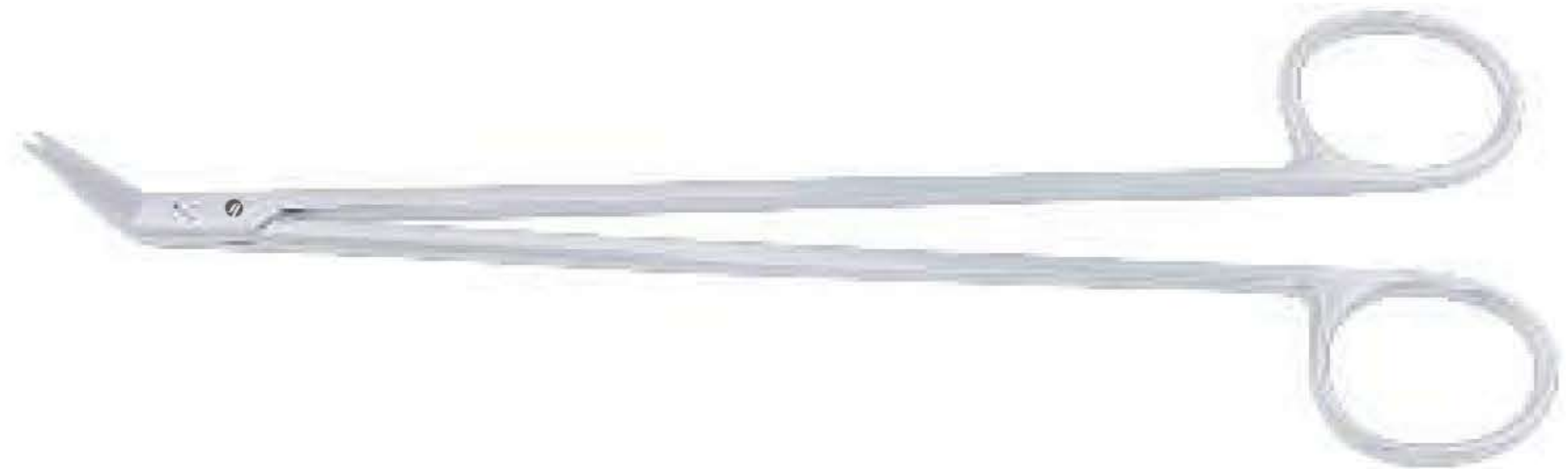

Vascular Scissors  
 Gefäßscheren  
 Tijeras vasculares  
 Ciseaux vasculaires  
 Forbici vascolari

**Diethrich-Potts Vascular Scissor**  
 Standard Blade



Catalog #	Size, Profile
SS-285-25	18 cm (7"), Angled 25°
SS-285-45	18 cm (7"), Angled 45°
SS-285-60	18 cm (7"), Angled 60°
SS-285-90	18 cm (7"), Angled 90°
SS-287-00	18 cm (7"), Angled 125°

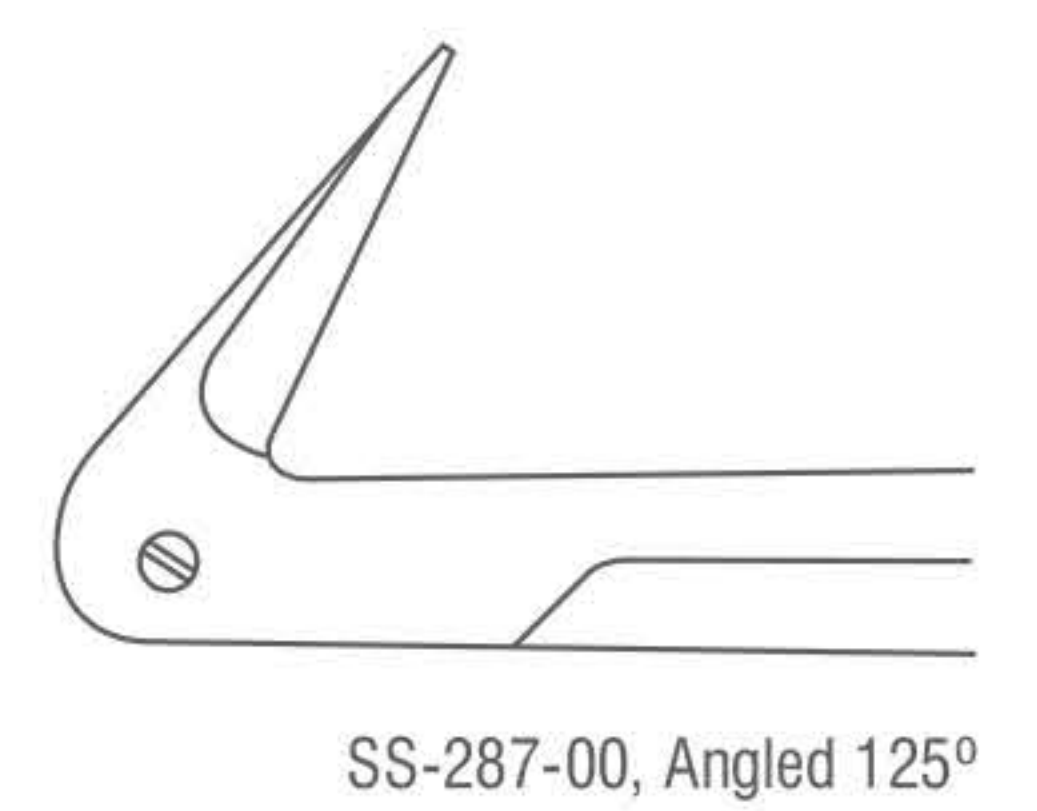
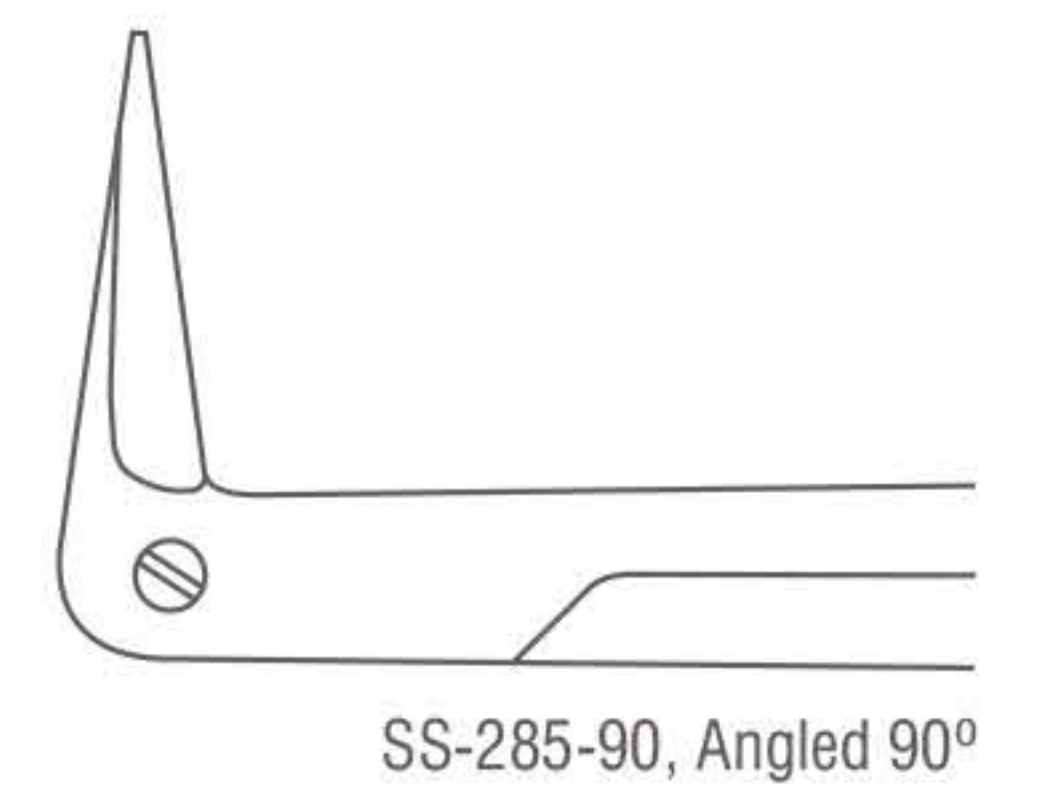
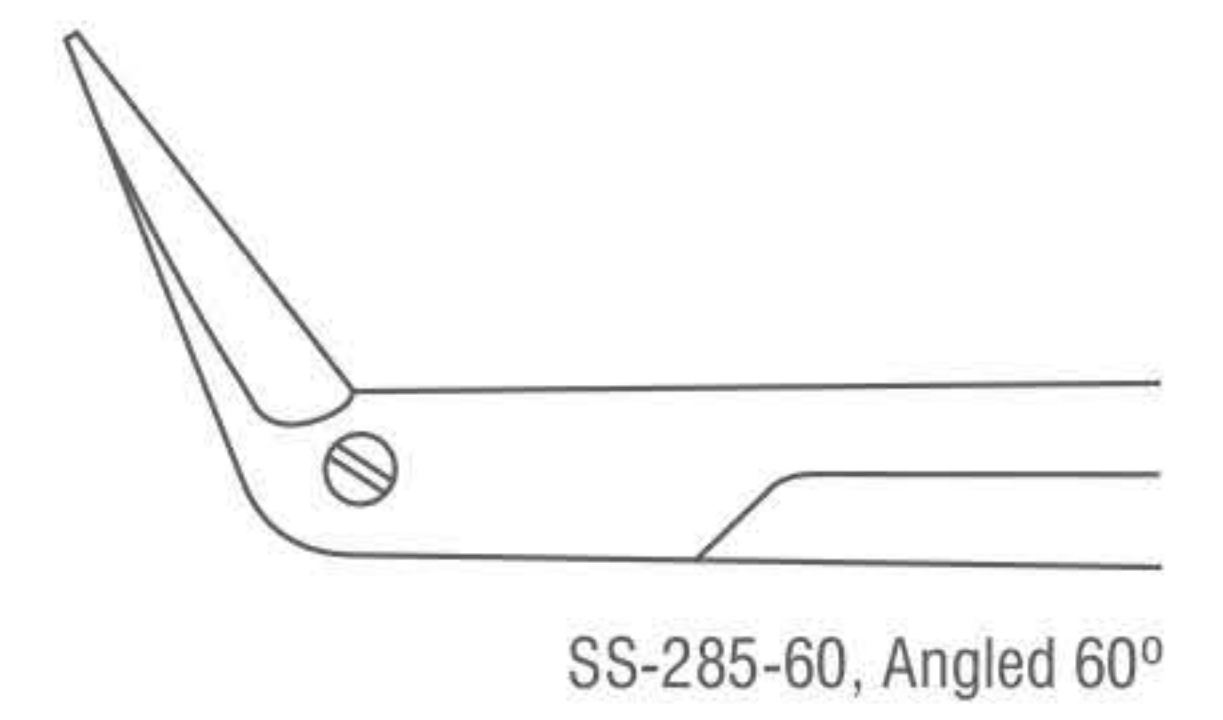
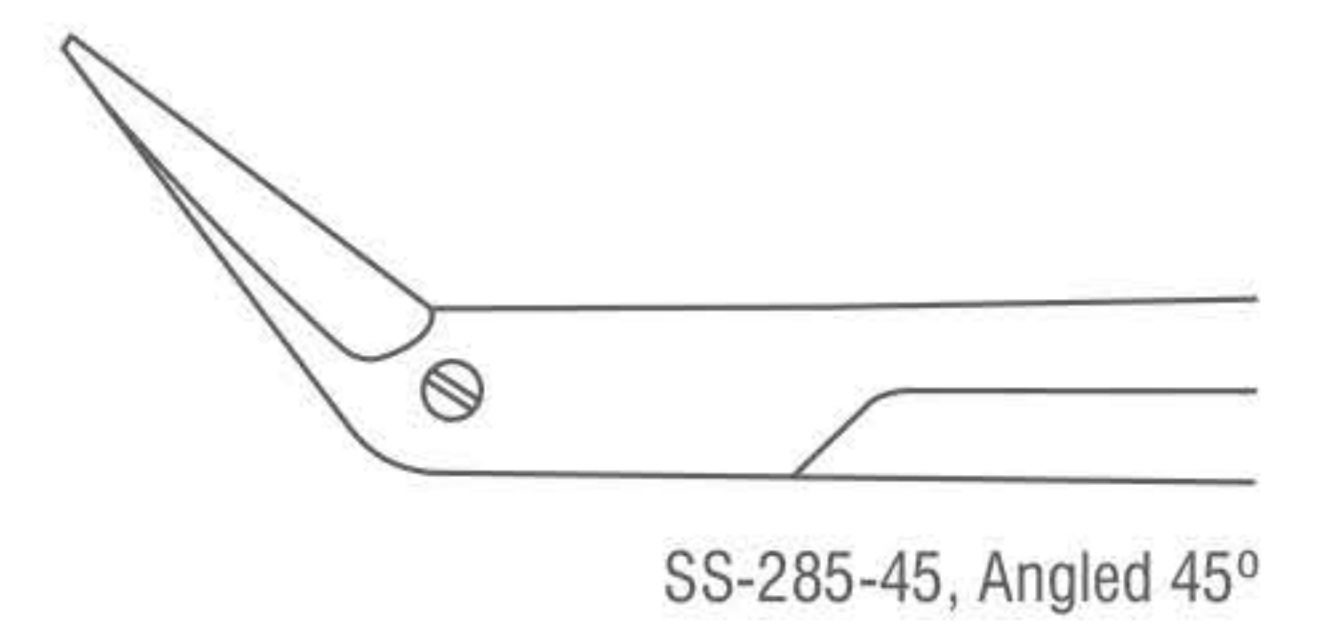
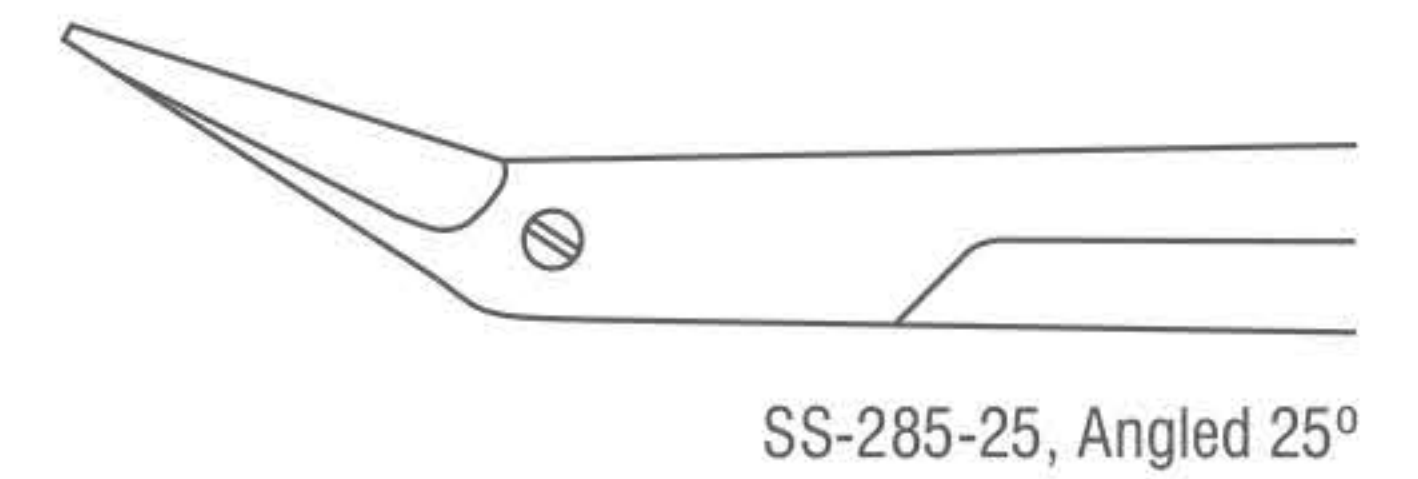

Vascular Scissors  
 Gefäßscheren  
 Tijeras vasculares  
 Ciseaux vasculaires  
 Forbici vascolari

**Diethrich-Potts Vascular Scissor**  
 Delicate Blade



Catalog #	Size, Profile
SS-289-25	18 cm (7"), Angled 25°
SS-289-45	18 cm (7"), Angled 45°
SS-289-60	18 cm (7"), Angled 60°
SS-289-90	18 cm (7"), Angled 90°
SS-291-00	18 cm (7"), Angled 125°

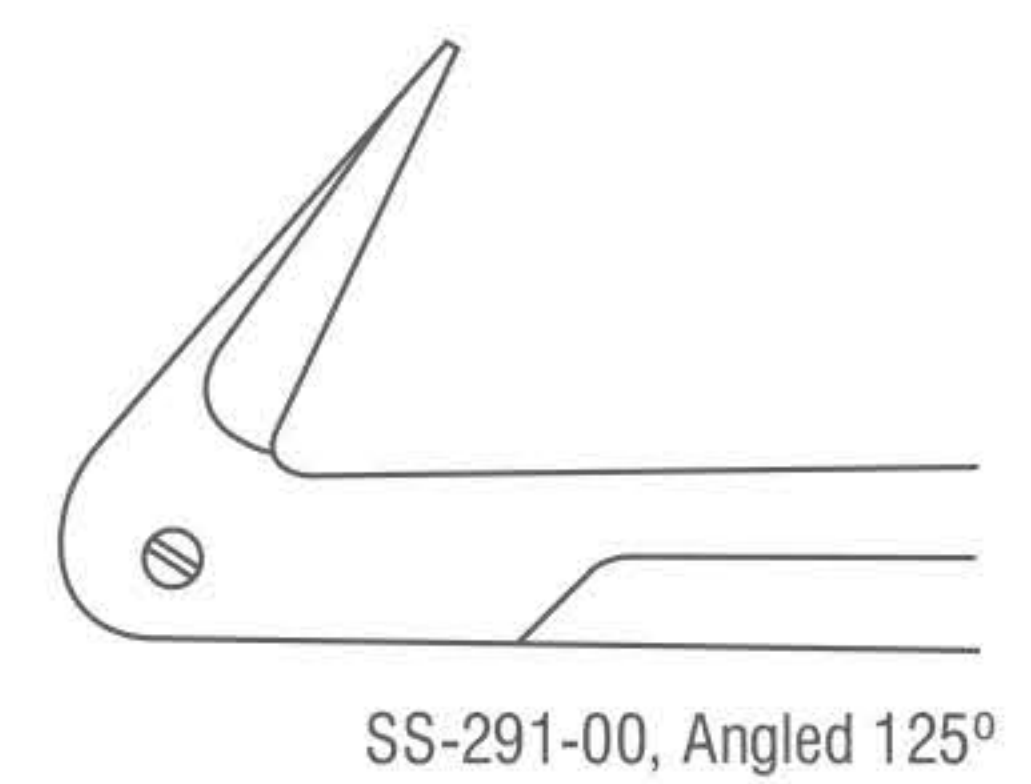
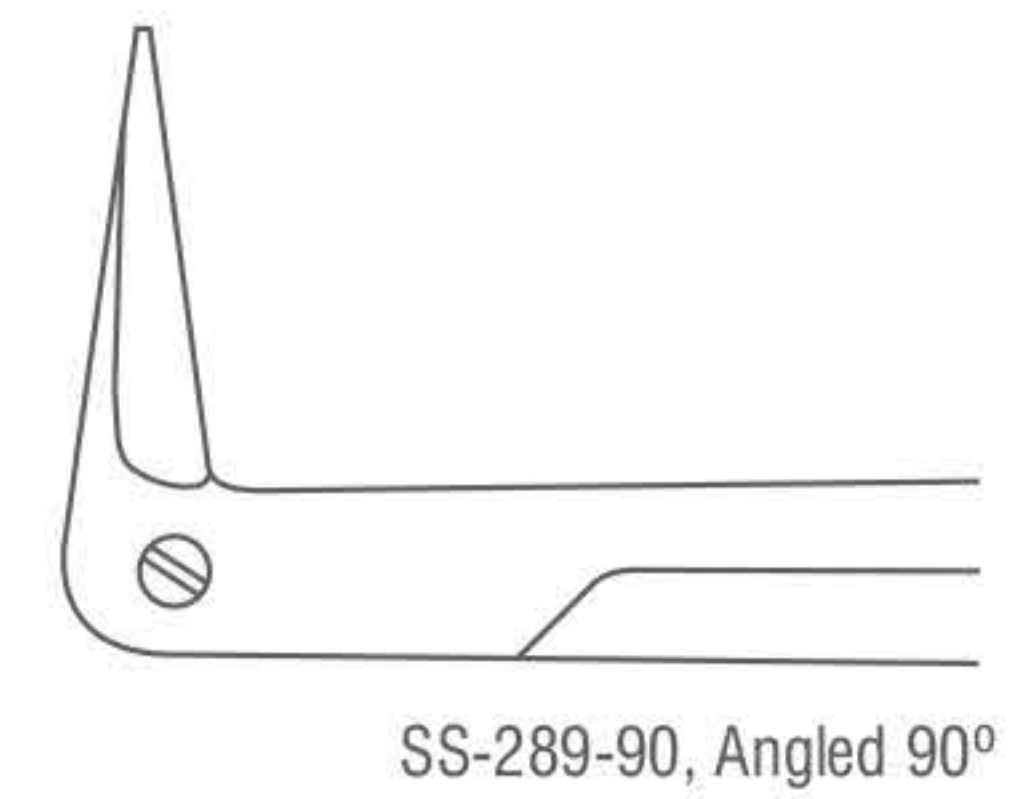
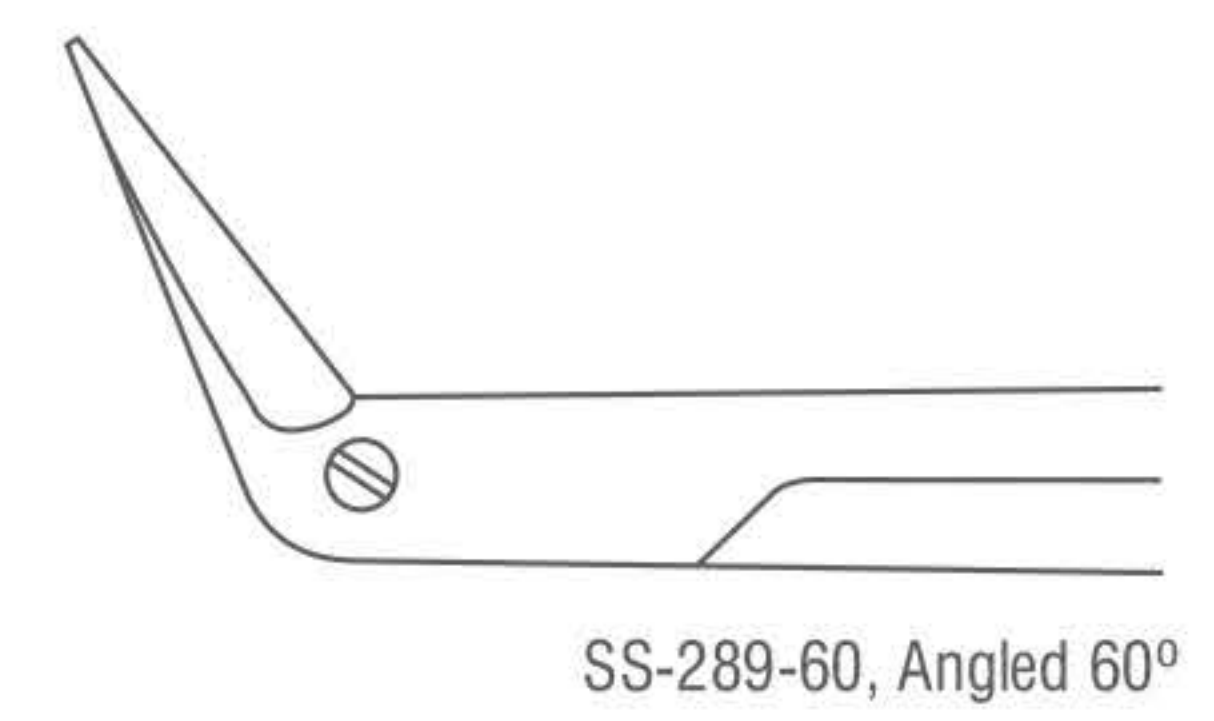
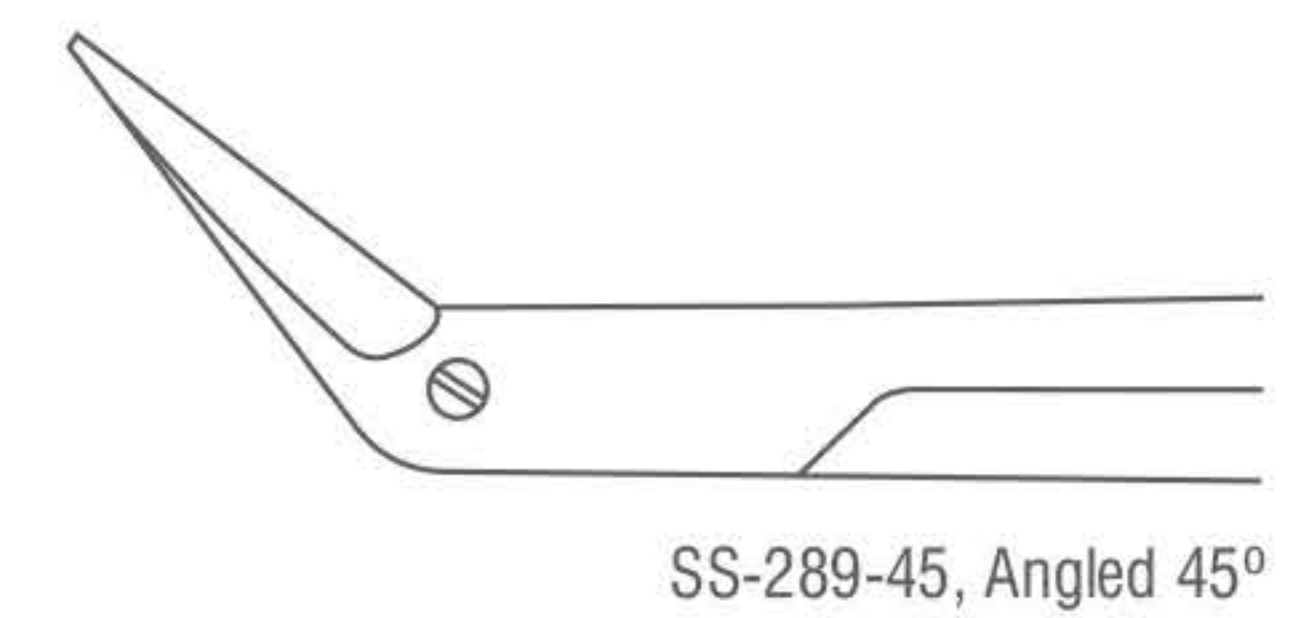
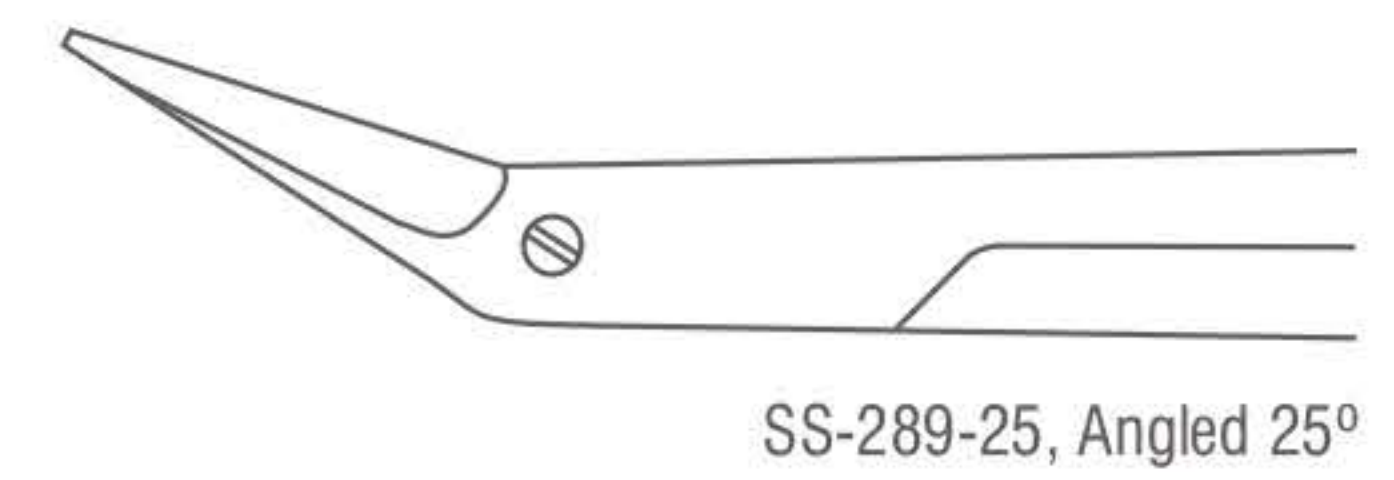

Vascular Scissors  
 Gefäßscheren  
 Tijeras vasculares  
 Ciseaux vasculaires  
 Forbici vascolari

**Diethrich-Potts Vascular Scissor**  
 Ultra Delicate Blade



Catalog #	Size, Profile
SS-293-25	18 cm (7"), Angled 25°
SS-293-45	18 cm (7"), Angled 45°
SS-293-60	18 cm (7"), Angled 60°
SS-293-90	18 cm (7"), Angled 90°
SS-295-00	18 cm (7"), Angled 125°

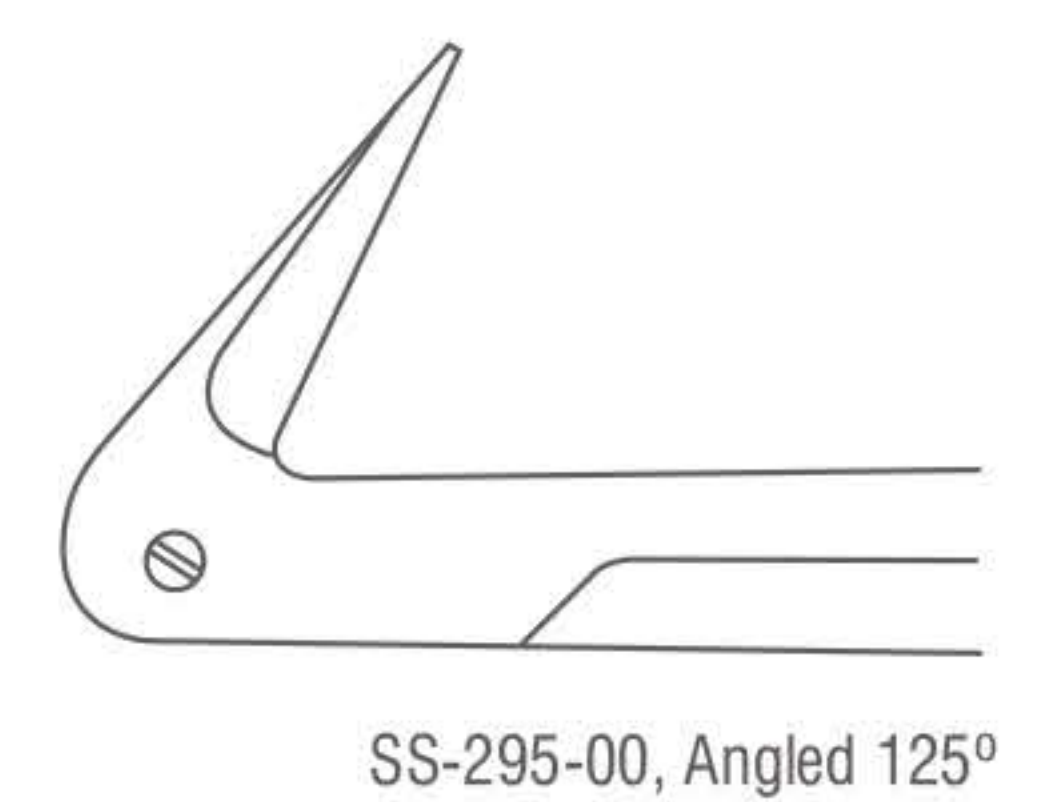
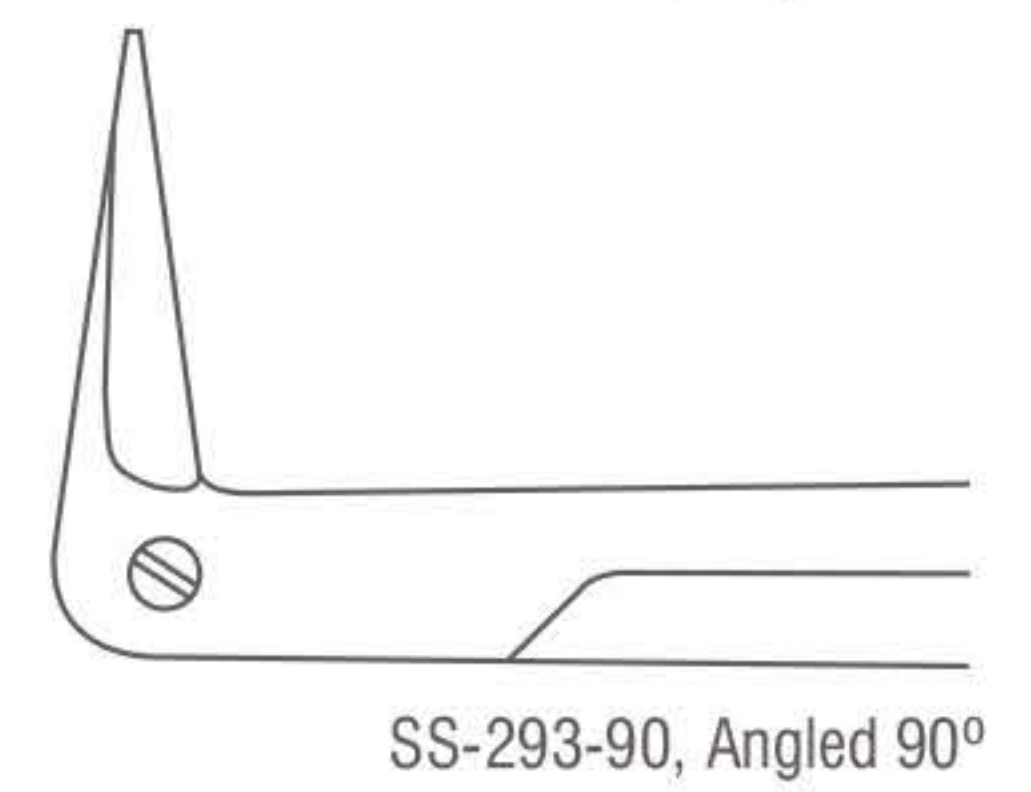
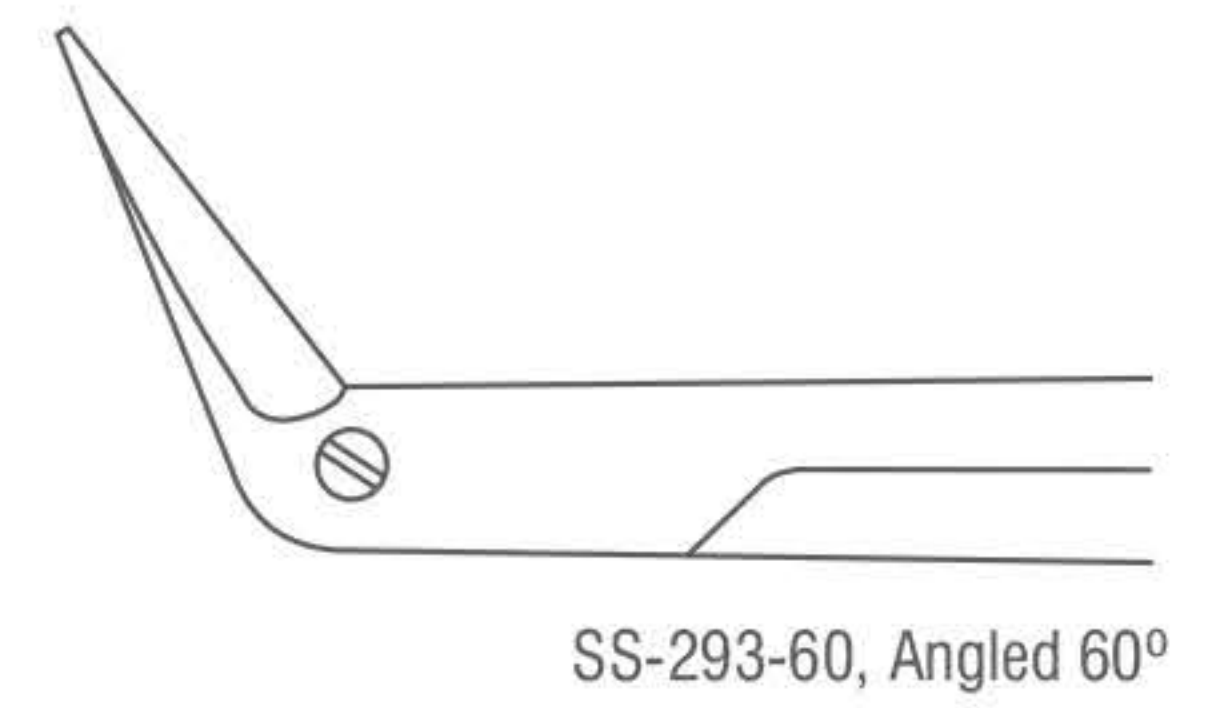
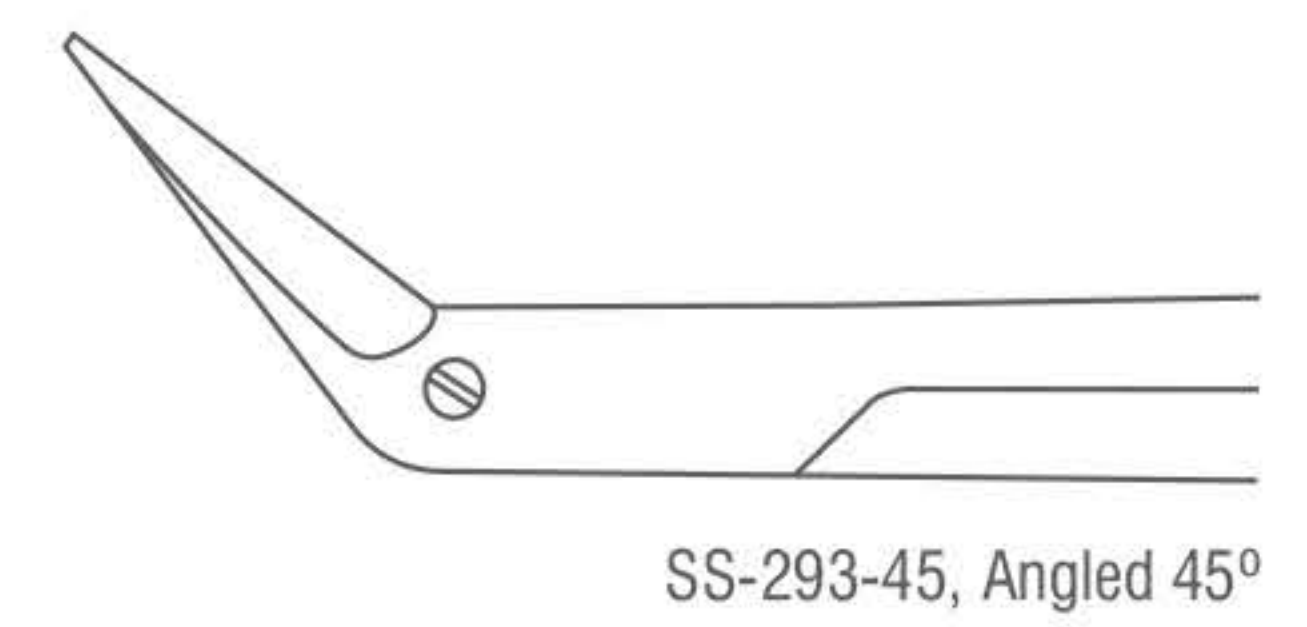
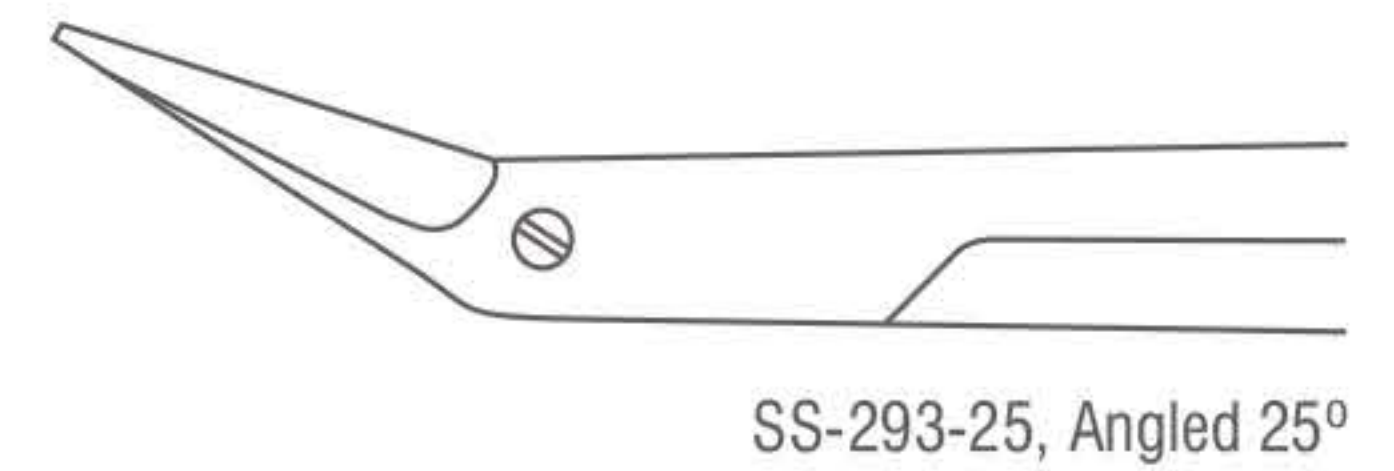

Vascular Scissors  
 Gefäßscheren  
 Tijeras vasculares  
 Ciseaux vasculaires  
 Forbici vascolari

**Potts-De Martel Cardiovascular Scissor**  
 Angled 60°



Catalog #	Size
SS-299-22	22 cm (8 3/4")

**DeBakey Offset Scissor**  
 S Shaped



Catalog #	Size
SS-301-16	15.5 cm (6")

**Favaloro Offset Scissor**  
 Angled



Catalog #	Size
SS-303-15	15 cm (6")

**Vascular Scissor**  
 One Blade Probe

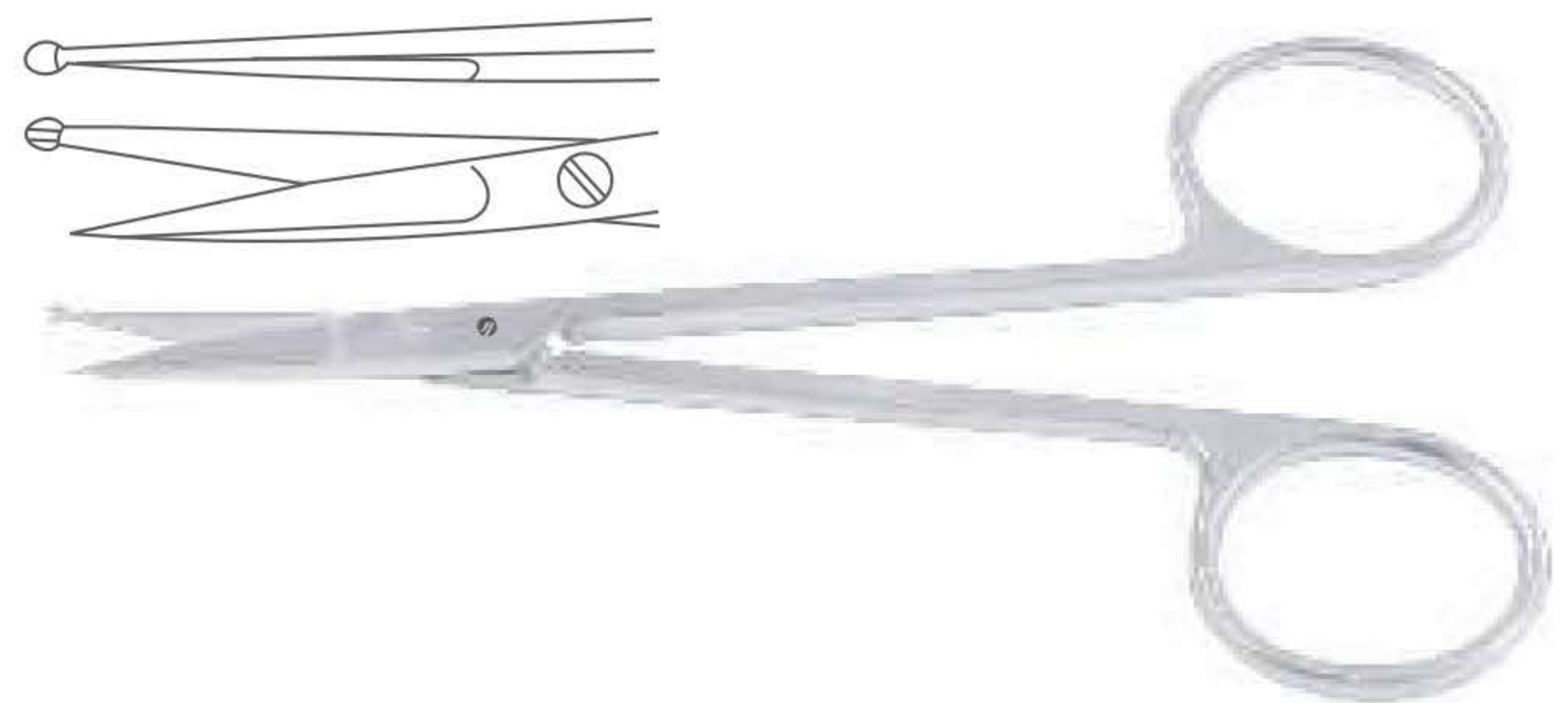

Catalog #	Size
SS-306-12	12 cm (4 3/4")

**Vascular Scissor**  
 One Blade Probe

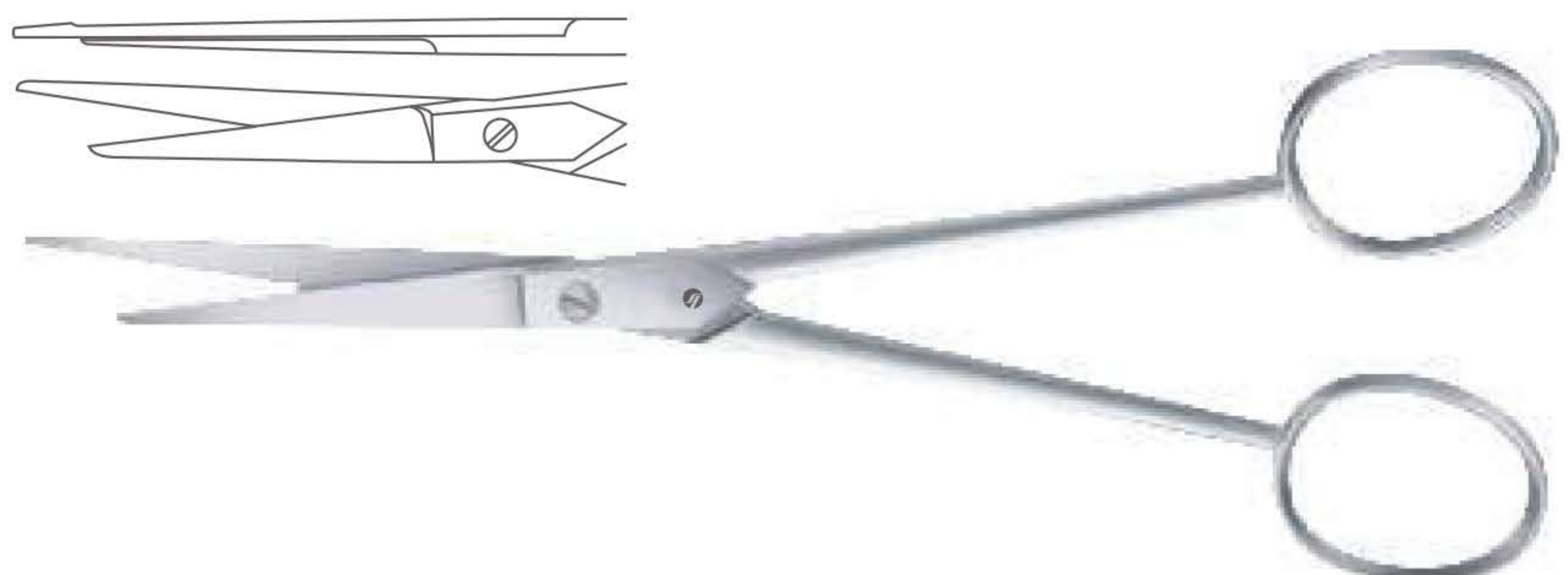

Catalog #	Size
SS-308-14	14.5 cm (5 3/4")

Vascular Scissors  
 Gefäßscheren  
 Tijeras vasculares  
 Ciseaux vasculaires  
 Forbici vascolari

**Strully Vascular Scissor**  
 Curved

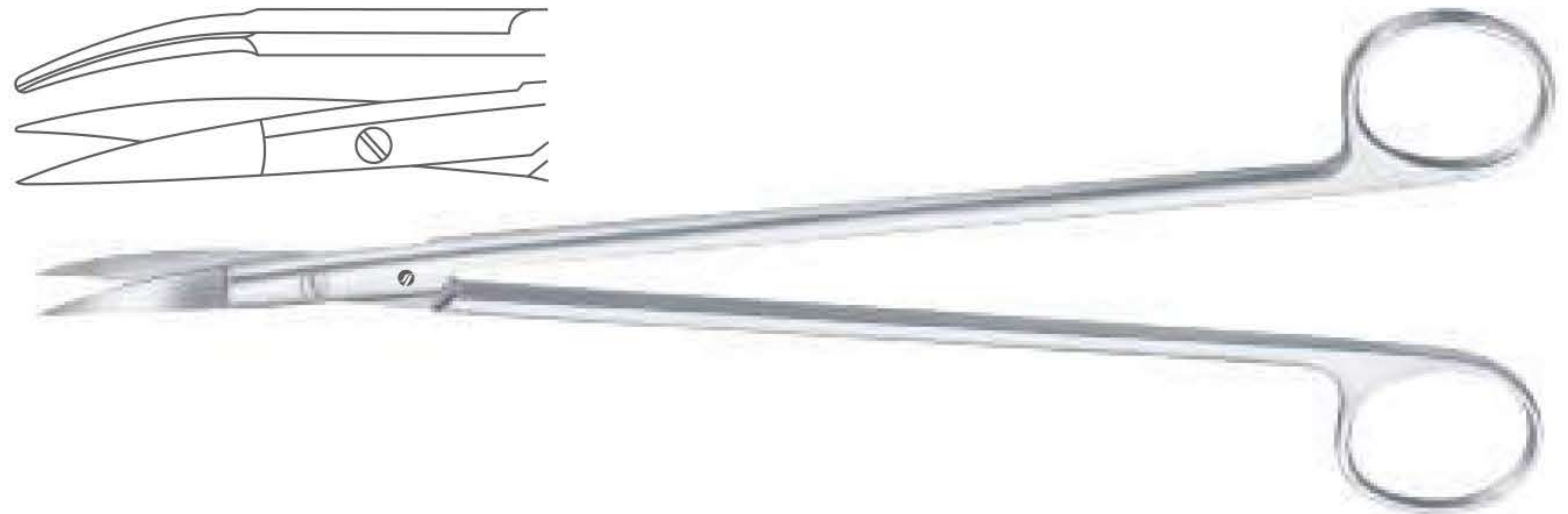

Catalog #	Size
SS-311-22	22 cm (8 3/4")

**Vascular Scissor**  
 Straight



Catalog #	Size
SS-312-22	22.5 cm (8 3/4")

**Barre Vascular Scissor**  
 Straight



Catalog #	Size
SS-314-28	28 cm (11")

**Potts-Smith Vascular Scissor**  
 Curved

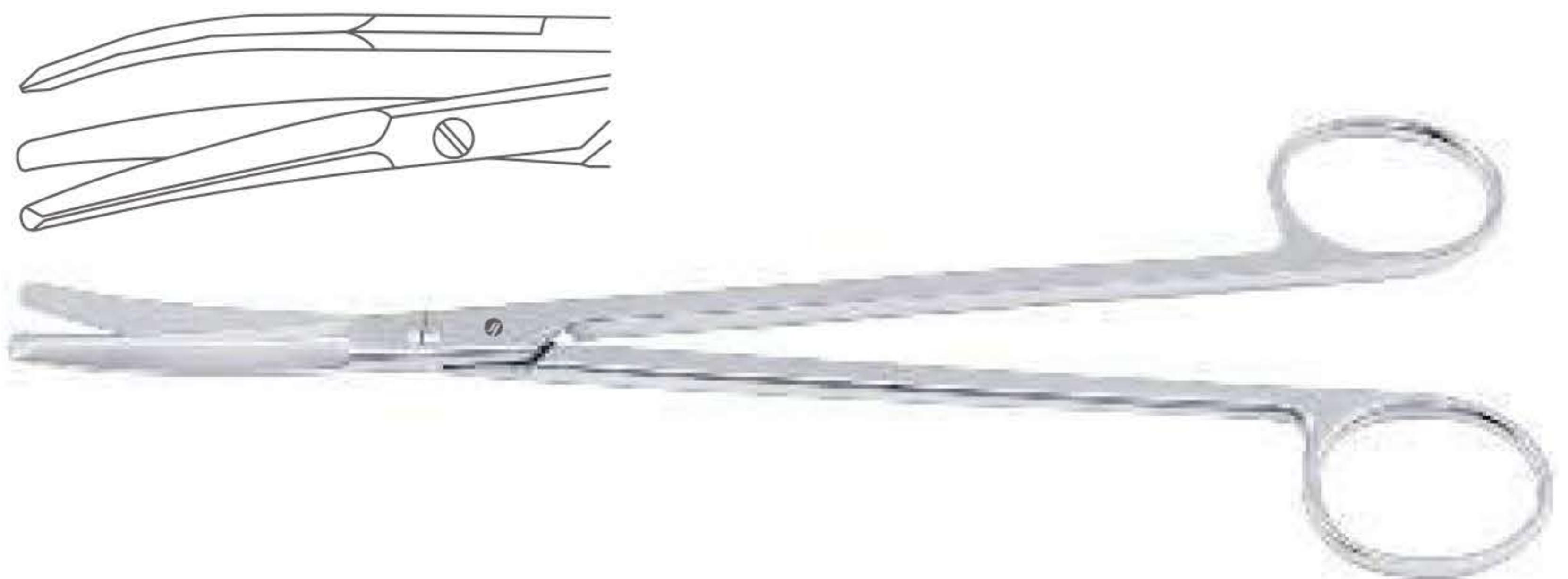

Catalog #	Size
SS-315-19	19 cm (7 1/2")

**Cooley Vascular Scissor**  
 Curved

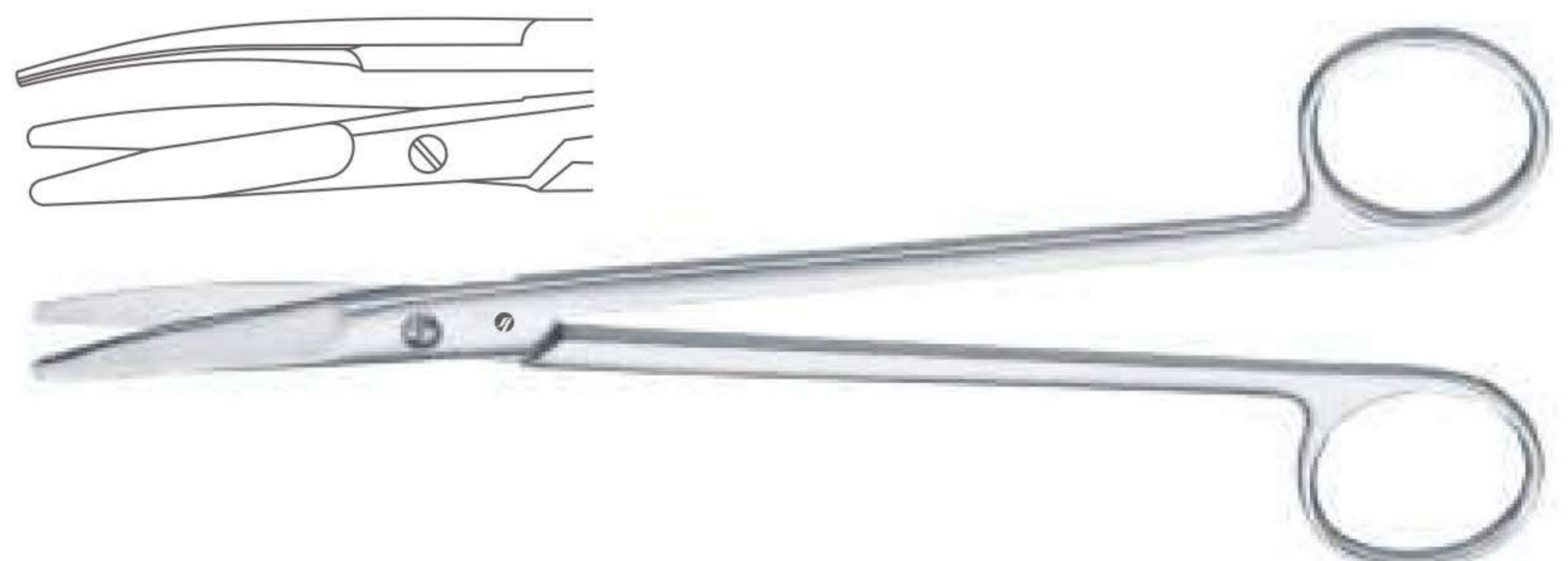

Catalog #	Size
SS-317-19	19 cm (7 1/2")

Vascular Scissors, Dissecting Scissors  
 Gefäßscheren  
 Tijeras vasculares, Tijeras de disección  
 Ciseaux vasculaires, Ciseaux à dissection  
 Forbici vascolari, Forbici per dissezione

**Klinkenberg-Loth Vascular Scissor**  
 S Shaped

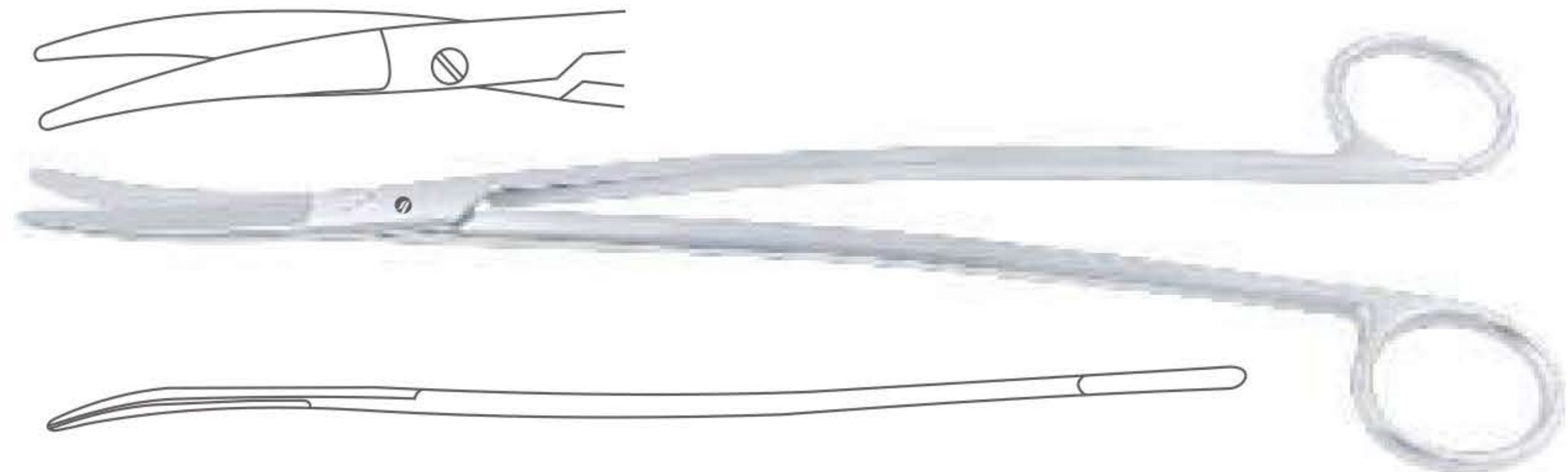

Catalog #	Size
SS-319-23	23 cm (9")

**Olivecrona Trigeminal Scissor**  
 Toothed



Catalog #	Size, Working Le
SS-323-23	23 cm (9"), 120

**Strully Neurological Scissor**  
 Curved

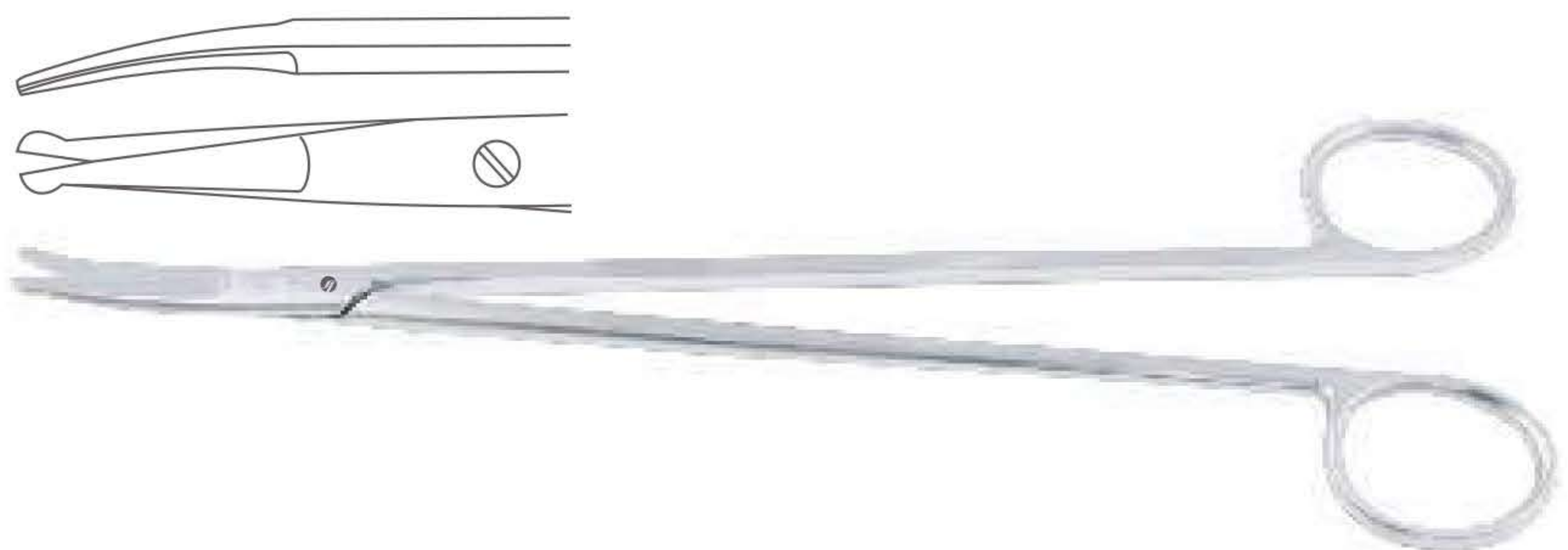

Catalog #	Size
SS-325-23	22.5 cm (8 3/4")

**Schmieden-Taylor Dissecting Scissor**  
 One Blade Probed

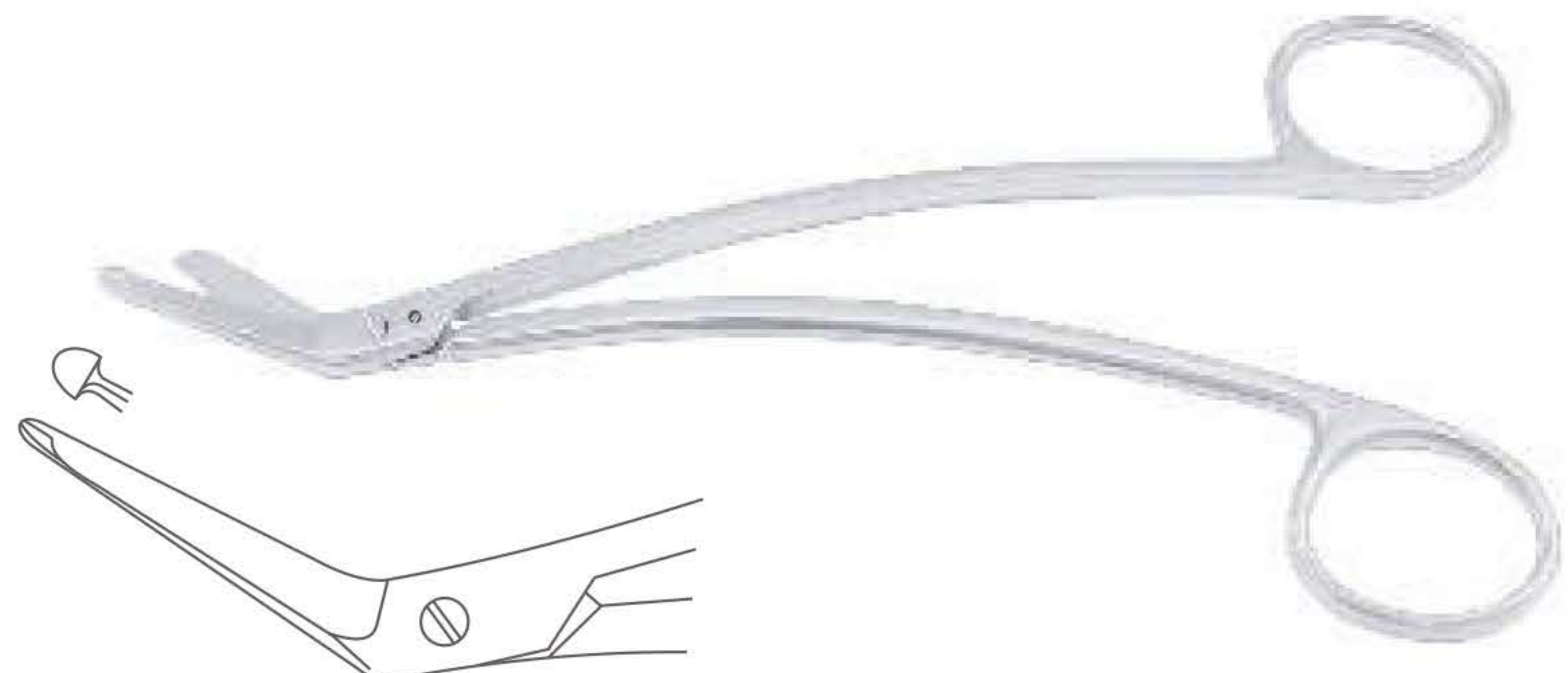

Catalog #	Size
SS-327-17	16.5 cm (6 1/2")

Dissecting Scissors  
 Präparierscheren  
 Tijeras de disección  
 Ciseaux à dissection  
 Forbici per dissezione

**Toennis-Adson Dissecting Scissor**  
 Curved

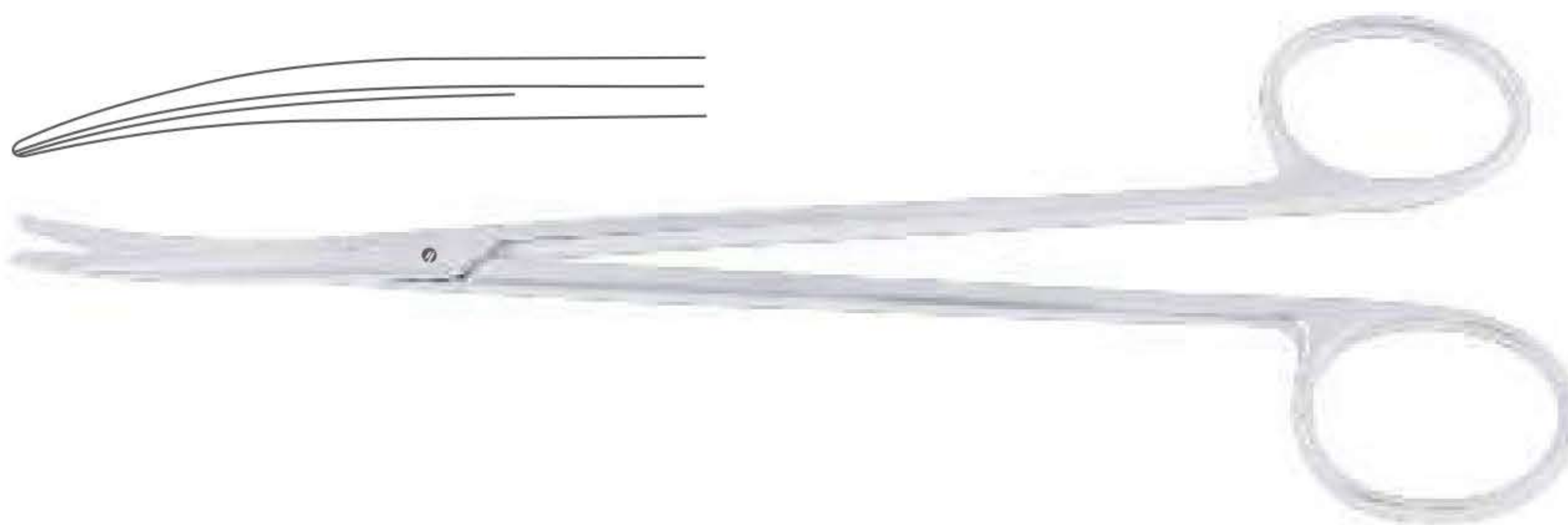

Catalog #	Size
SS-329-17	17.5 cm (7")

**Toennis Dissecting Scissor**  
 Straight, Very Delicate

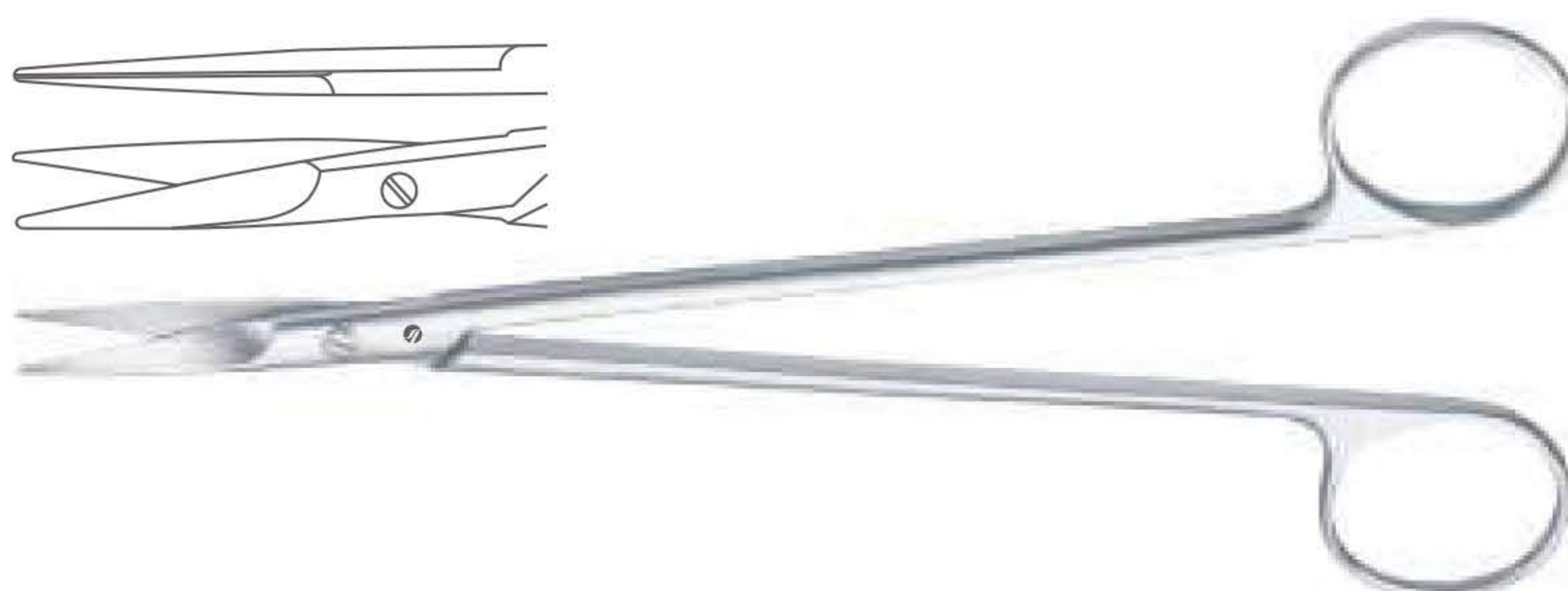

Catalog #	Size
SS-332-18	18 cm (7")

**Toennis Dissecting Scissor**  
 Straight, Delicate



Catalog #	Size
SS-334-18	18 cm (7")

**Toennis Dissecting Scissor**  
 Curved, Delicate

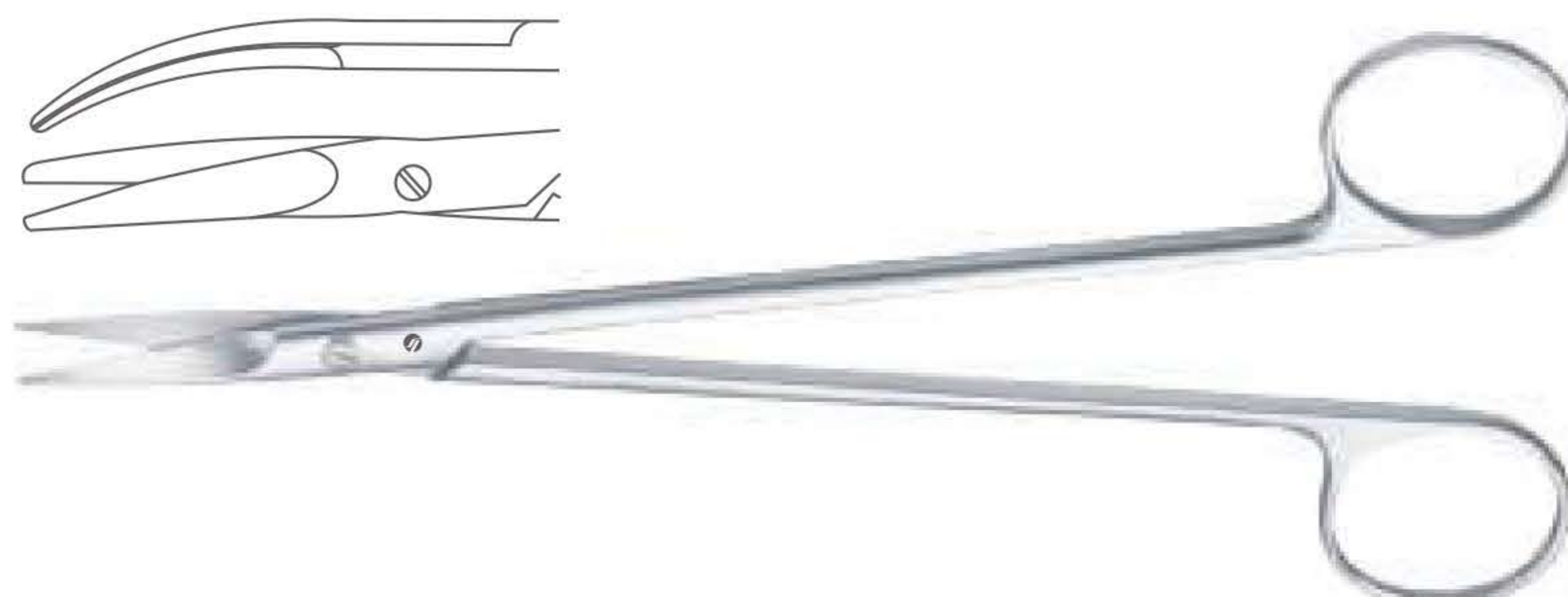

Catalog #	Size
SS-335-18	18 cm (7")

**Killian Bone Shear**

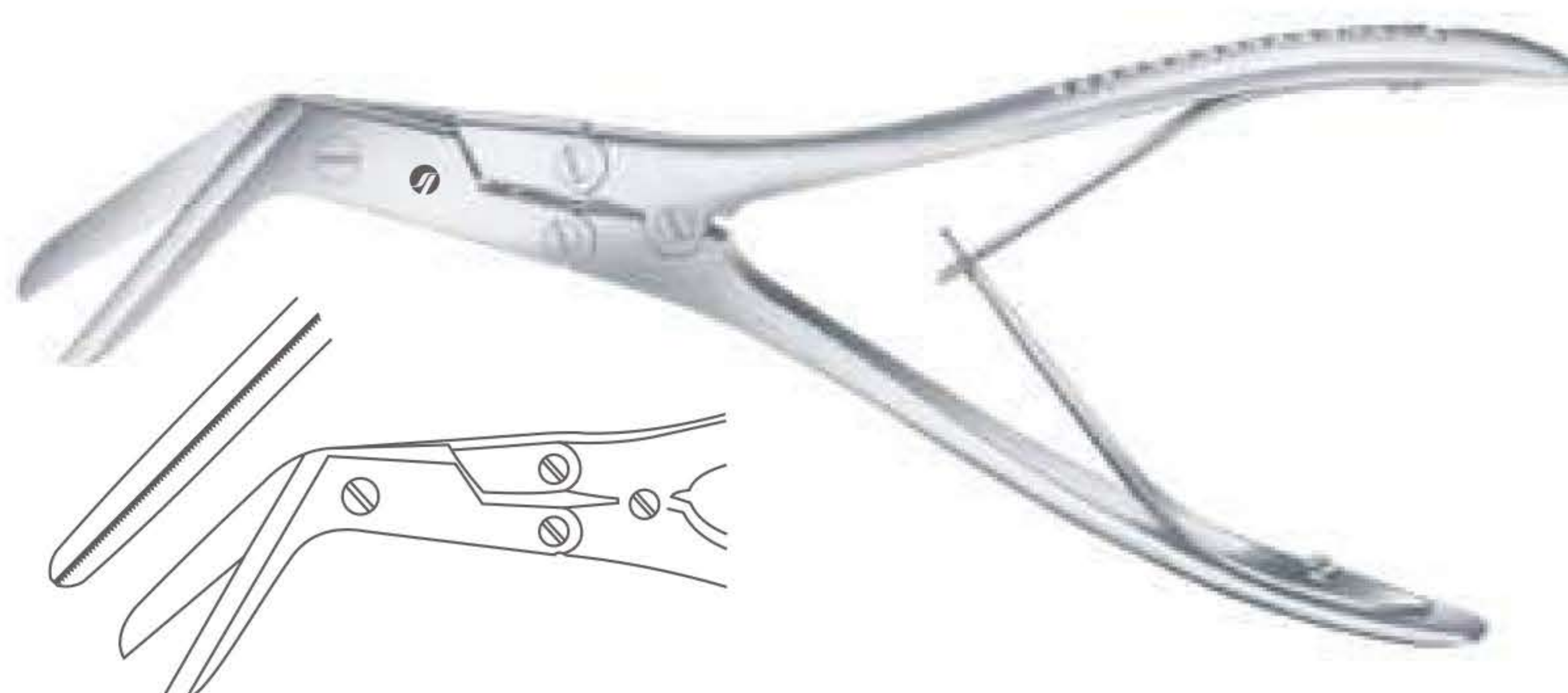

Catalog #	Size
SS-341-21	21 cm (8 1/4")

Tonsil and Nasal Scissors  
 Tonsillen und Nasenscheren  
 Tijeras para amígdalas, Tijeras nasales  
 Ciseaux pour les amygdales, Ciseaux nasaux  
 Forbici per tonsille, Forbici nasali

**Muehling Bone Shear**

Catalog #	Size
SS-343-21	21 cm (8 1/4")

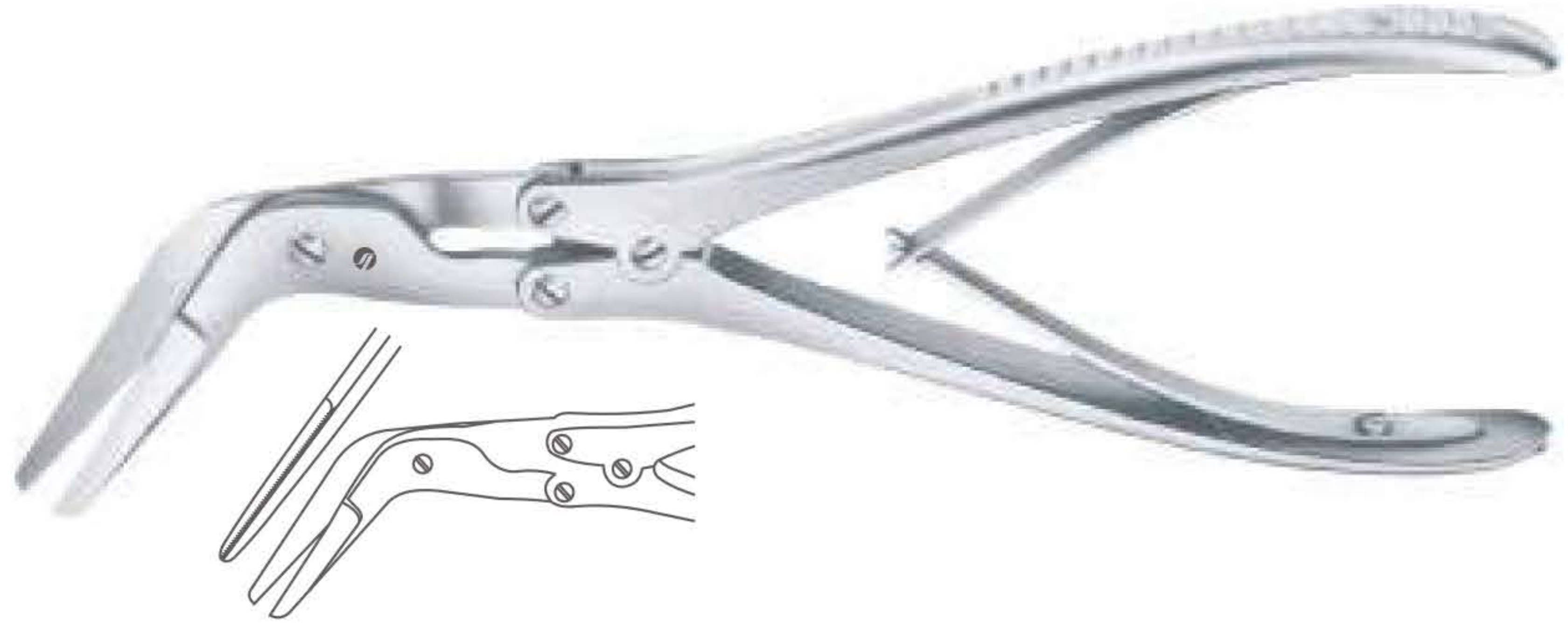

**Caplan Septum Scissor**  
 One Toothed Cutting Edge

Catalog #	Size
SS-345-20	20 cm (8")



**Prince Tonsil Scissor**

Catalog #	Size
SS-347-18	18 cm (7")



**Dean Tonsil Scissor**  
 Angled Upwards

Catalog #	Size
SS-351-17	17.5 cm (7")



**Dean Tonsil Scissor**  
 Toothed, Angled Upwards

Catalog #	Size
SS-353-17	17.5 cm (7")



Tonsil and Nasal Scissors  
 Tonsillen und Nasenscheren  
 Tijeras para amígdalas, Tijeras nasales  
 Ciseaux pour les amygdales, Ciseaux nasaux  
 Forbici per tonsille, Forbici nasali

**Good Tonsil Scissor**



Catalog #	Size
SS-355-19	19.5 cm (7 ¾")

**Fomon Nasal Scissor**



Catalog #	Size
SS-357-15	15 cm (6")

**Fomon Nasal Scissor**



**SUPER Edge™**

Catalog #	Size
SS-357-15 SC	15 cm (6")

**Cottle Nasal Scissor**

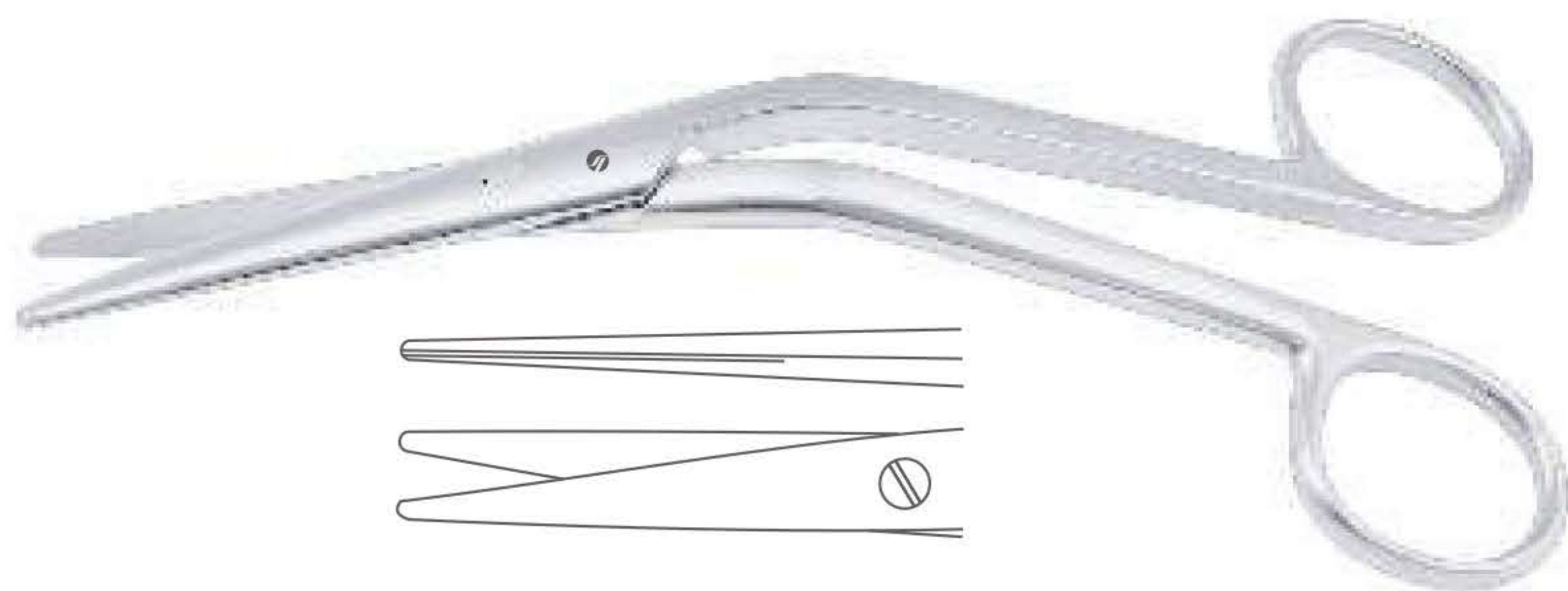

Catalog #	Size
SS-359-16	16 cm (6 ¼")

**Cottle Nasal Scissor**

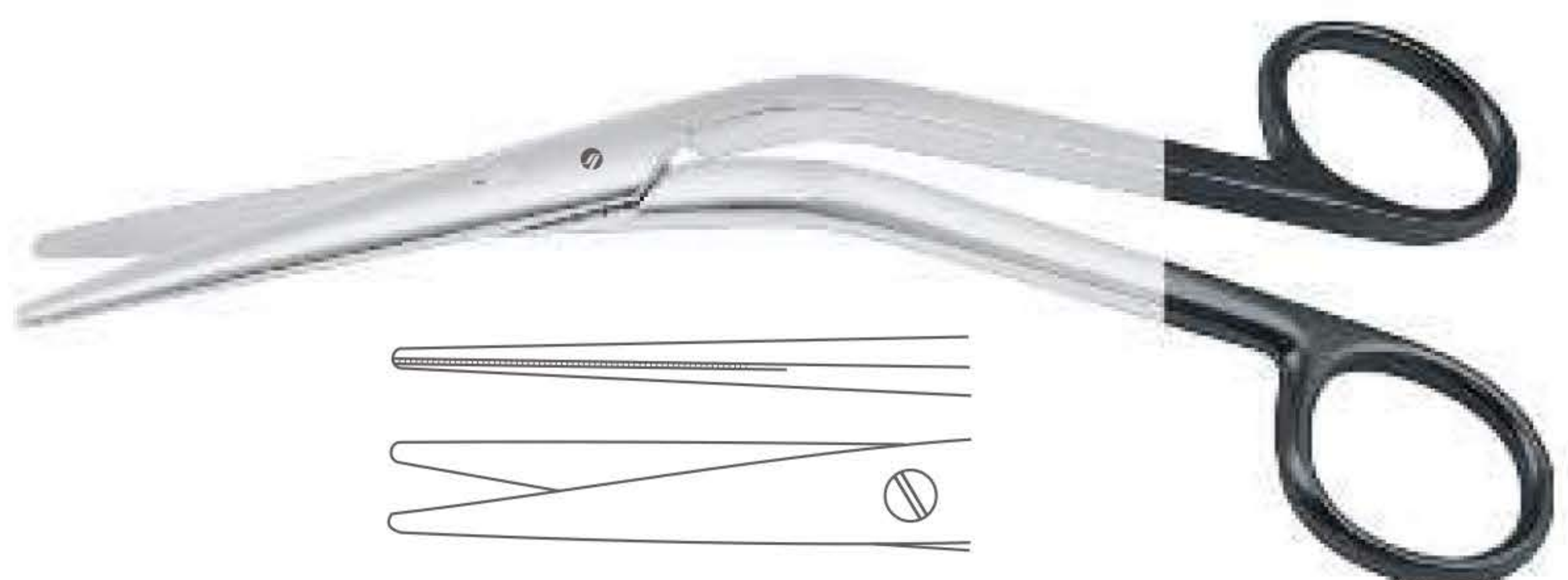

**SUPER Edge™**

Catalog #	Size
SS-359-16 SC	16 cm (6 ¼")

Nasal Scissors, Episiotomy Scissors  
 Nasenscheren, Episiotomiescheren  
 Tijeras nasals, Tijeras para episiotomía  
 Ciseaux nasaux, Ciseaux à épisiotomie  
 Forbici nasali, Forbici per episiotomia

**Heymann Nasal Scissor**

Catalog #	Size
SS-361-18	18.5 cm (7 ¼")



**Heymann Nasal Scissor**

Catalog #	Size
SS-361-18 SC	18.5 cm (7 ¼")



**Heymann Nasal Scissor**  
 One Toothed Cutting Edge

Catalog #	Size
SS-363-18	18.5 cm (7 ¼")



**Converse (Graefe) Nasal Scissor**  
 Angled, Blunt/Blunt

Catalog #	Size
SS-367-11	10.5 cm (4 ¼")



**Converse Nasal Scissor**  
 Angled, Sharp/Sharp

Catalog #	Size
SS-369-11	10.5 cm (4 ¼")



Nasal Scissors, Episiotomy Scissors, Umbilical Scissors  
 Nasenscheren, Episiotomiescheren, Nabelschnurscheren  
 Tijeras nasals, Tijeras para episiotomía, Tijeras umbilicales  
 Ciseaux nasaux, Ciseaux à épisiotomie, Ciseaux pour le cordon ombilical  
 Forbici nasali, Forbici per episiotomia, Forbici ombelicali

**Waldmann Nasal Scissor**  
 One Toothed Cutting Edge

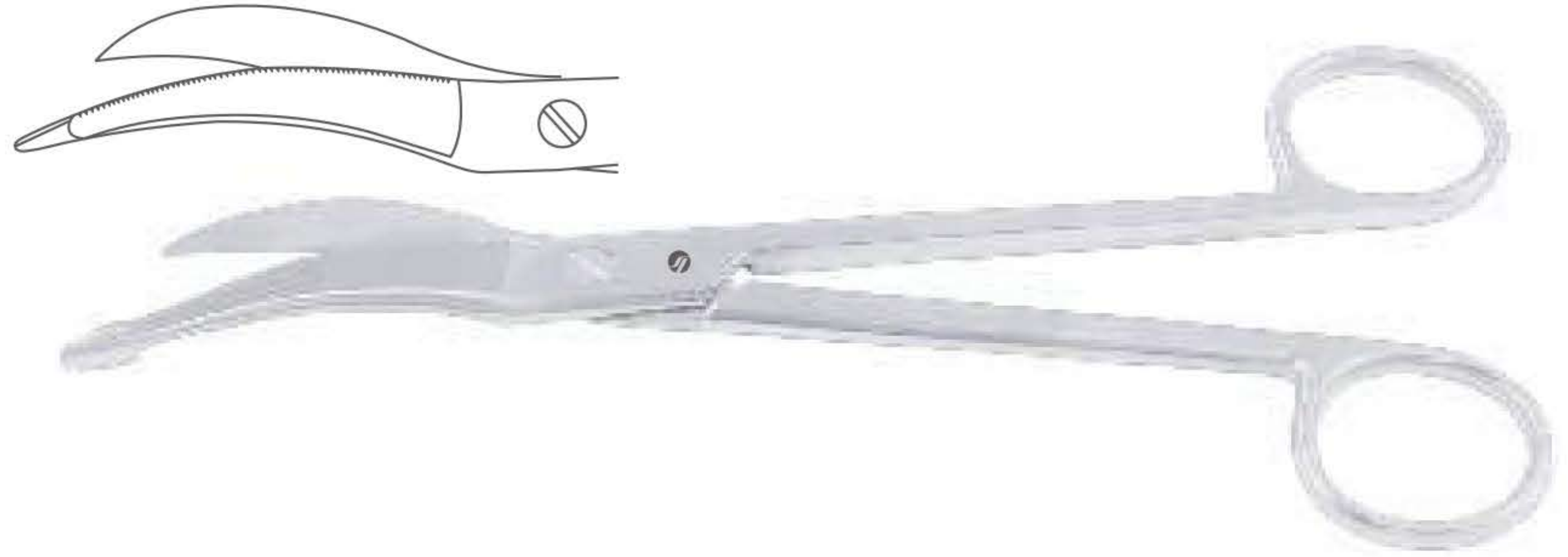

Catalog #	Size
SS-373-18	18 cm (7")

**Braun-Stadler Episiotomy Scissor**



Catalog #	Size
SS-381-14	14.5 cm (5 3/4")

**Braun-Stadler Episiotomy Scissor**



Catalog #	Size
SS-383-20	20 cm (8")
SS-383-22	22 cm (8 3/4")

**Modell USA Umbilical Cord Scissor**



Catalog #	Size
SS-385-10	10.5 cm (4 1/4")

**Schumacher Umbilical Cord Scissor**

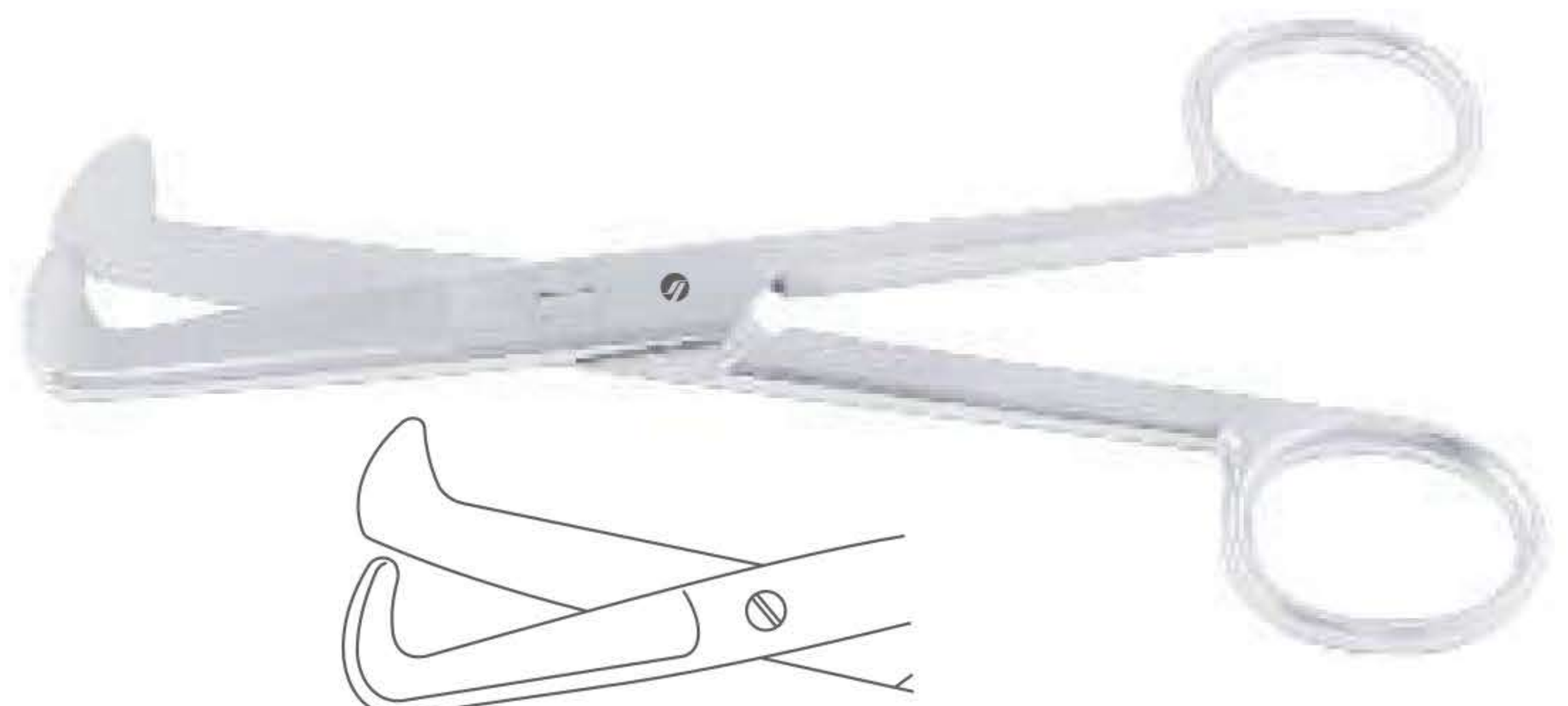

Catalog #	Size
SS-387-16	16 cm (6 1/4")

Umbilical Scissors, Gum Scissors  
 Nabelschnurscheren, Zahnfleischscheren  
 Tijeras umbilicales, Tijeras para encías  
 Ciseaux pour le cordon ombilical, Ciseaux à gencives  
 Forbici ombelicali, Forbici per gengiva

**Busch Umbilical Cord Scissor**



Catalog #	Size
SS-389-16	16 cm (6 1/4")

**Busch Umbilical Cord Scissor**  
 One Toothed Cutting Edge

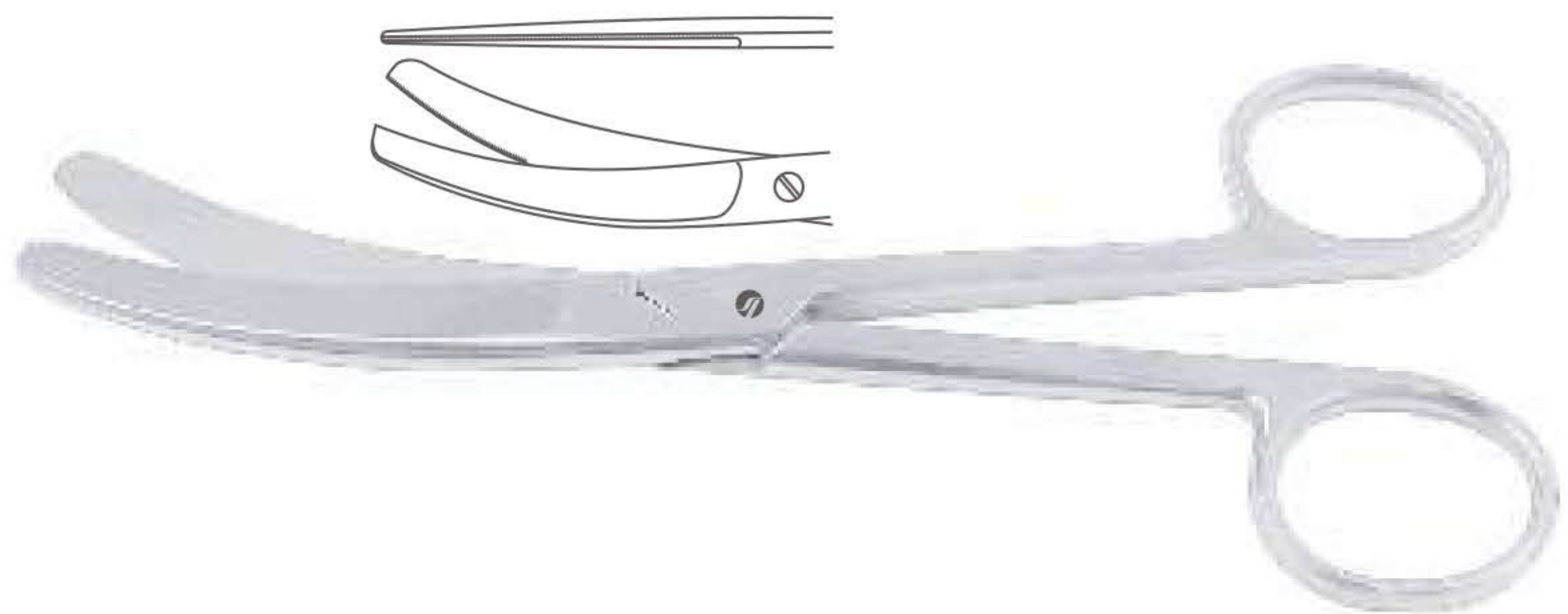

Catalog #	Size
SS-391-16	16 cm (6 1/4")

**Goldman-Fox Gum Scissor**  
 Straight



Catalog #	Size
SS-400-13	13 cm (5")

**Goldman-Fox Gum Scissor**  
 Straight

**SUPER Edge™**

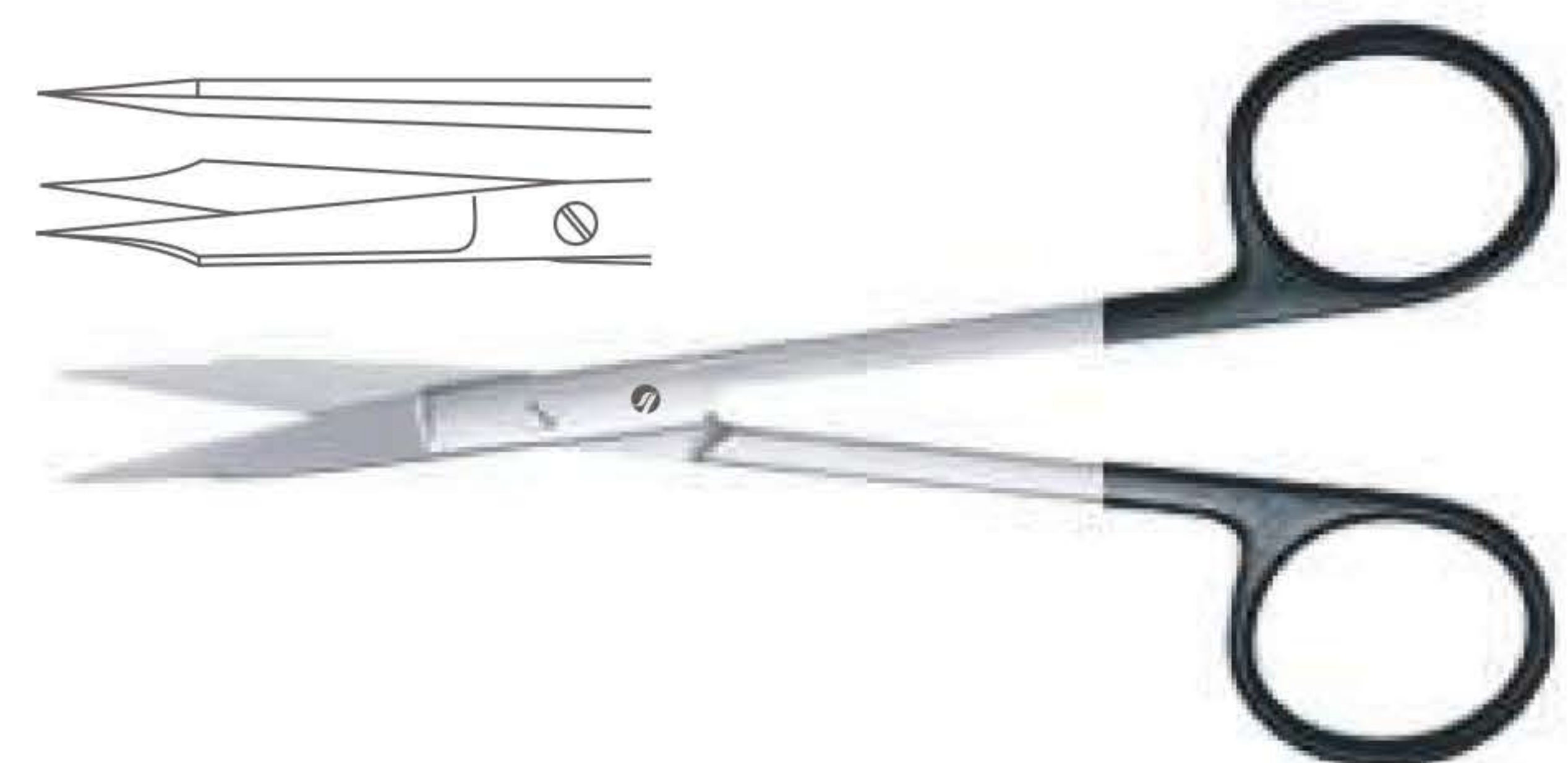

Catalog #	Size
SS-400-13 SC	13 cm (5")

**Goldman-Fox Gum Scissor**  
 Curved



Catalog #	Size
SS-401-13	13 cm (5")

Gum Scissors, Operating Scissors  
 Zahnfleissscheren, Chirurgische Scheren  
 Tijeras para encías, Tijeras quirúrgicas  
 Ciseaux à gencives, Ciseaux chirurgicaux  
 Forbici per gengiva, Forbici per chirurgia

**Goldman-Fox Gum Scissor**  
 Curved

**SUPER Edge™**

Catalog #	Size
SS-401-13 SC	13 cm (5")



**Wagner Operating Scissor**  
 Straight

Catalog #	Size
SS-402-12	12 cm (4 3/4")



**Wagner Operating Scissor**  
 Straight

**SUPER Edge™**

Catalog #	Size
SS-402-12 SC	12 cm (4 3/4")



**Wagner Operating Scissor**  
 Curved

Catalog #	Size
SS-403-12	12 cm (4 3/4")



**Wagner Operating Scissor**  
 Curved

**SUPER Edge™**

Catalog #	Size
SS-403-12 SC	12 cm (4 3/4")



Operating Scissors, Gum Scissors  
 Chirurgische Scheren, Zahnfleischscheren  
 Tijeras quirúrgicas, Tijeras para encías  
 Ciseaux chirurgicaux, Ciseaux à gencives  
 Forbici per chirurgia, Forbici per gengiva

**Fine Pattern Operating Scissor**  
 Straight, Sharp/Blunt



Catalog #	Size
SS-406-12	12 cm (4 ¾")

**Fine Pattern Operating Scissor**  
 Curved, Sharp/Blunt



Catalog #	Size
SS-407-12	12 cm (4 ¾")

**Fine Pattern Operating Scissor**  
 Straight, Sharp/Sharp



Catalog #	Size
SS-408-12	12 cm (4 ¾")

**Fine Pattern Operating Scissor**  
 Curved, Sharp/Sharp



Catalog #	Size
SS-409-12	12 cm (4 ¾")

**La Grange Gum Scissor**  
 S Shaped

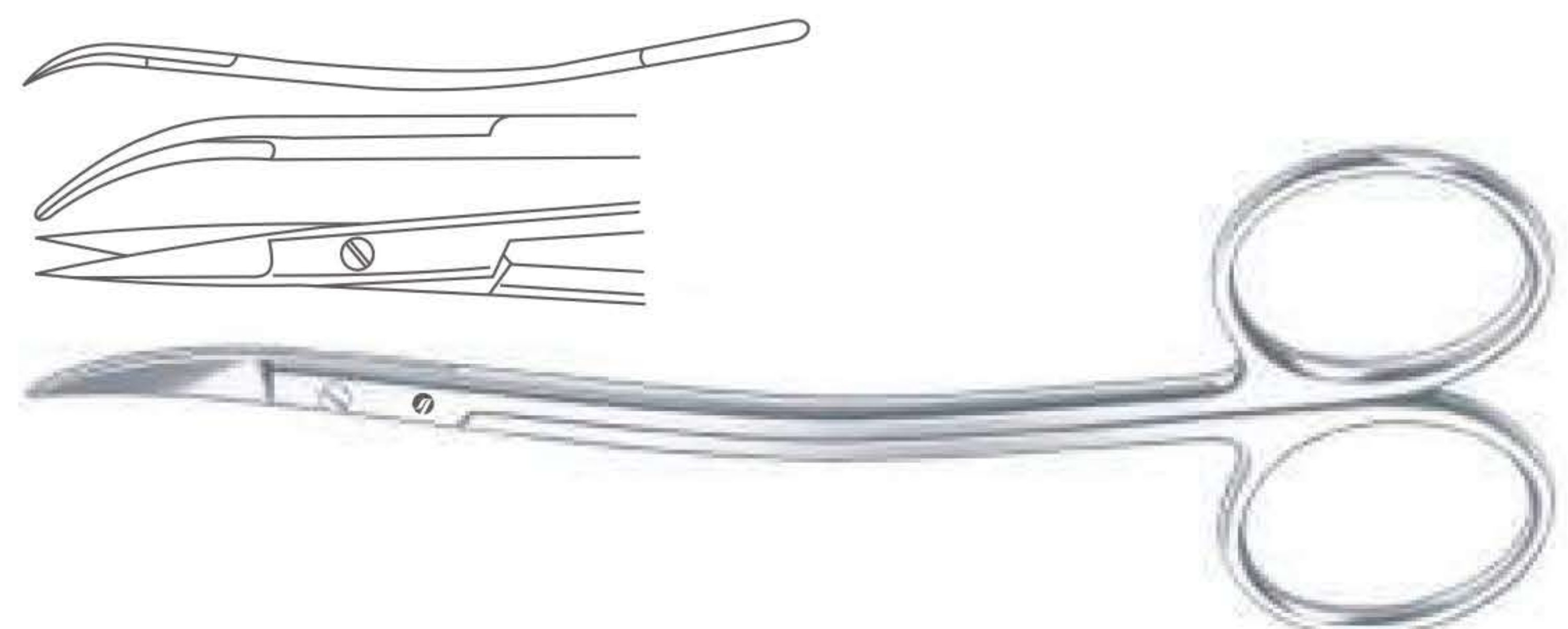

Catalog #	Size
SS-411-11	11.5 cm (4 ½")

Gum Scissors, Operating Scissors  
 Zahnfleissscheren, Chirurgische Scheren  
 Tijeras para encías, Tijeras quirúrgicas  
 Ciseaux à gencives, Ciseaux chirurgicaux  
 Forbici per gengiva, Forbici per chirurgia

**Delicate Gum Scissor**  
 Straight



Catalog #	Size
SS-414-11	11.5 cm (4 1/2")

**Delicate Gum Scissor**  
 Curved

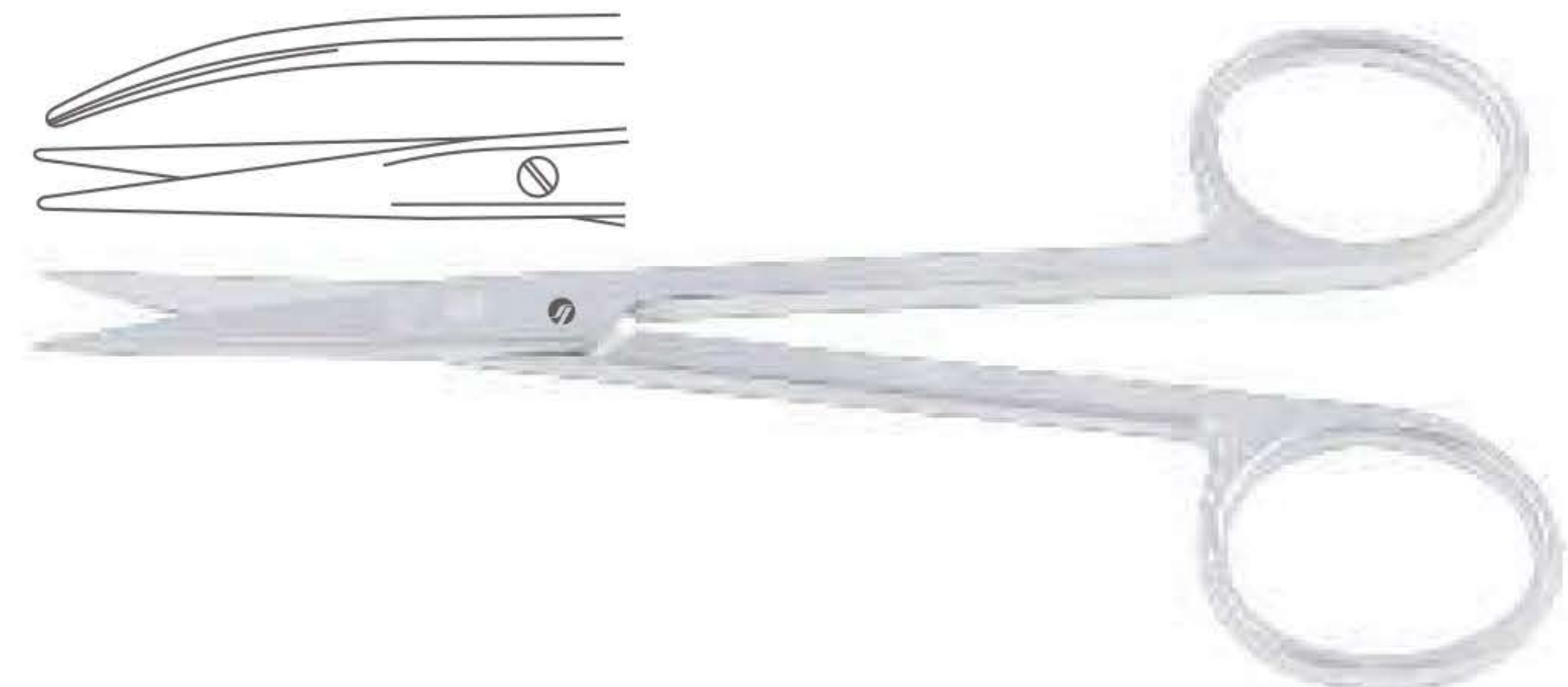

Catalog #	Size
SS-415-11	11.5 cm (4 1/2")

**Locklin Gum Scissor**  
 Angled, One Toothed Cutting Edge



Catalog #	Size
SS-417-16	16 cm (6 1/4")

**Locklin Gum Scissor**  
 Angled, S Shaped, One Toothed Cutting Edge

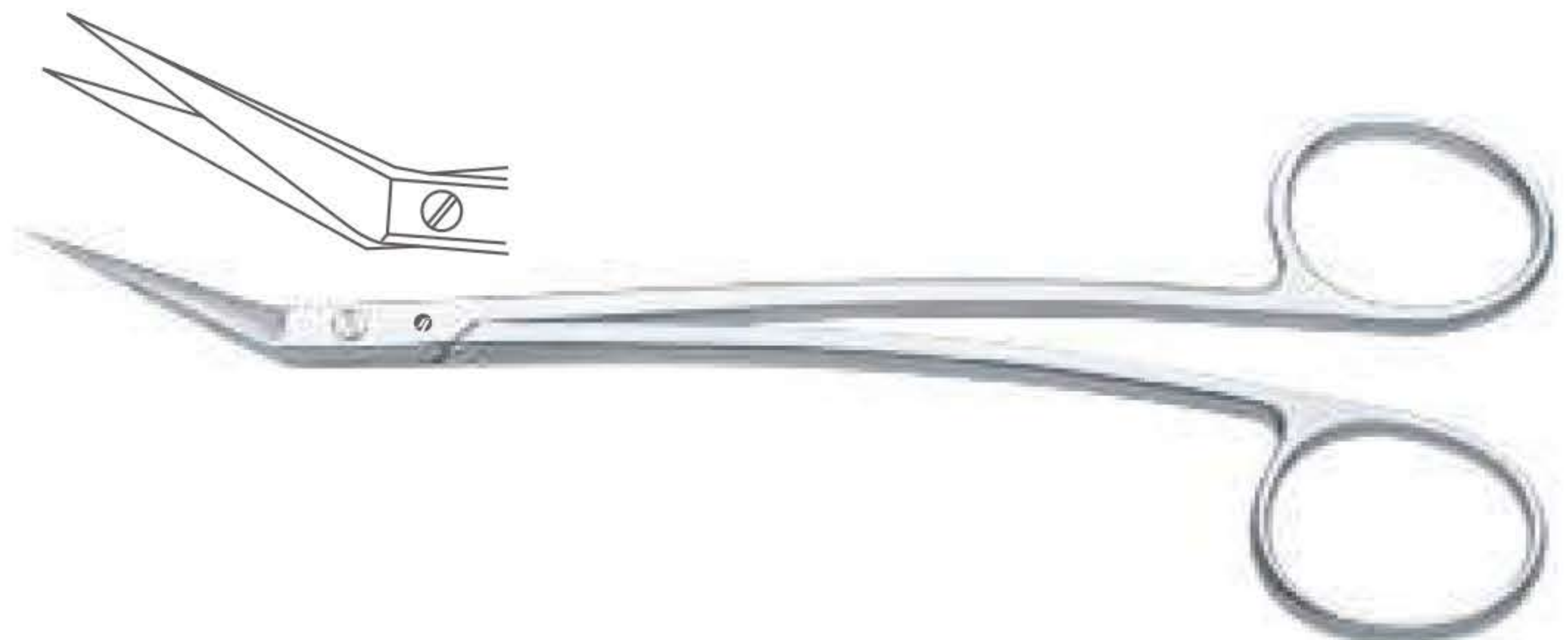

Catalog #	Size
SS-419-16	16 cm (6 1/4")

**Very Delicate Operating Scissor**  
 Straight



Catalog #	Size
SS-422-09	9 cm (3 1/2")

Operating Scissors, Iris Scissors  
 Chirurgische Scheren, Irisscheren  
 Tijeras quirúrgicas, Tijeras para iridectomía  
 Ciseaux chirurgicaux, Ciseaux à iridectomie  
 Forbici per chirurgia, Forbici per iridectomia

**Very Delicate Operating Scissor**  
 Curved

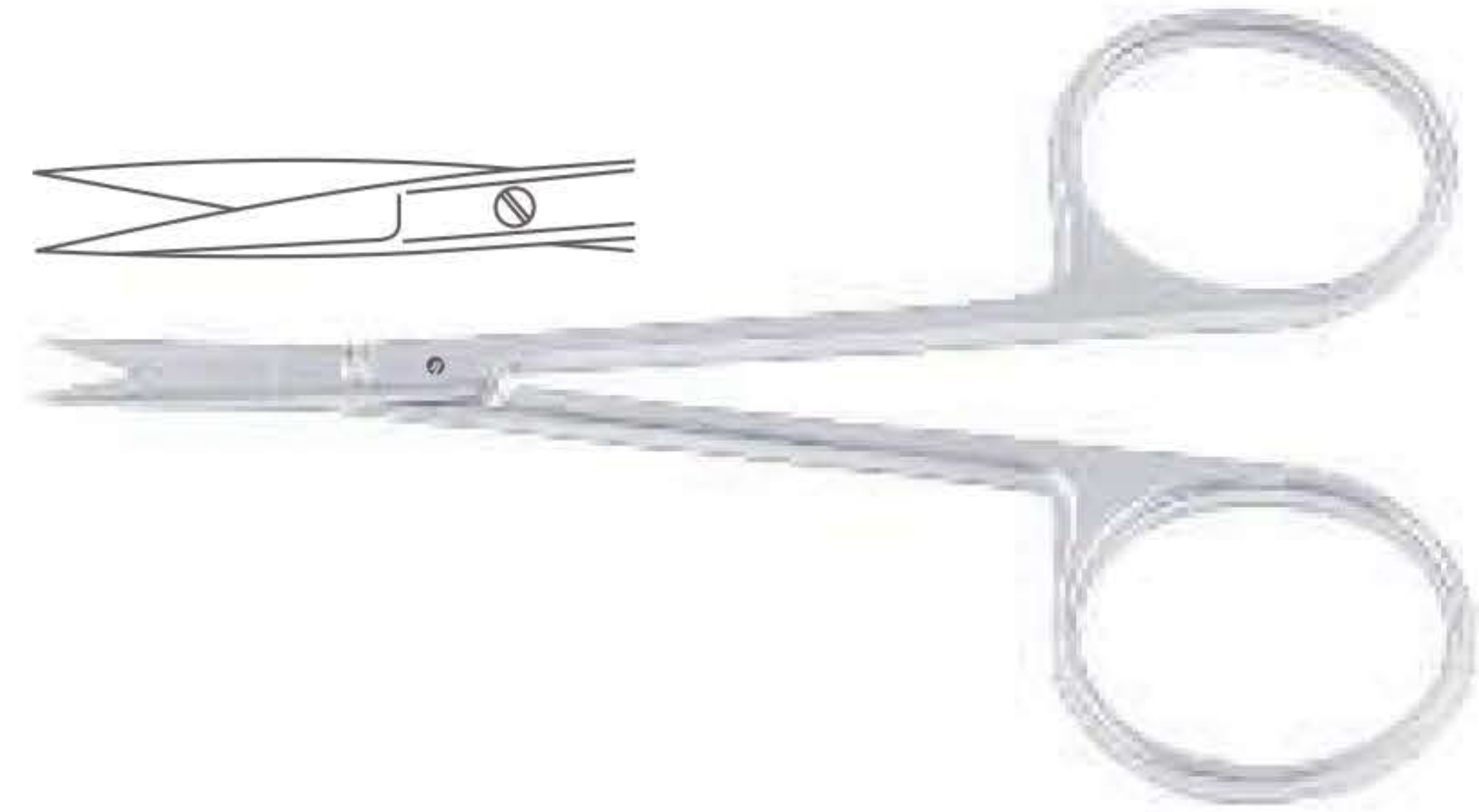

Catalog #	Size
SS-423-09	9 cm (3 1/2")

**Iris Scissor**  
 Straight



Catalog #	Size
SS-430-09	9 cm (3 1/2")
SS-430-10	10 cm (4")

**Iris Scissor**  
 Curved



Catalog #	Size
SS-431-09	9 cm (3 1/2")
SS-431-10	10 cm (4")

**Iris Scissor**  
 With Extra Flat Blades

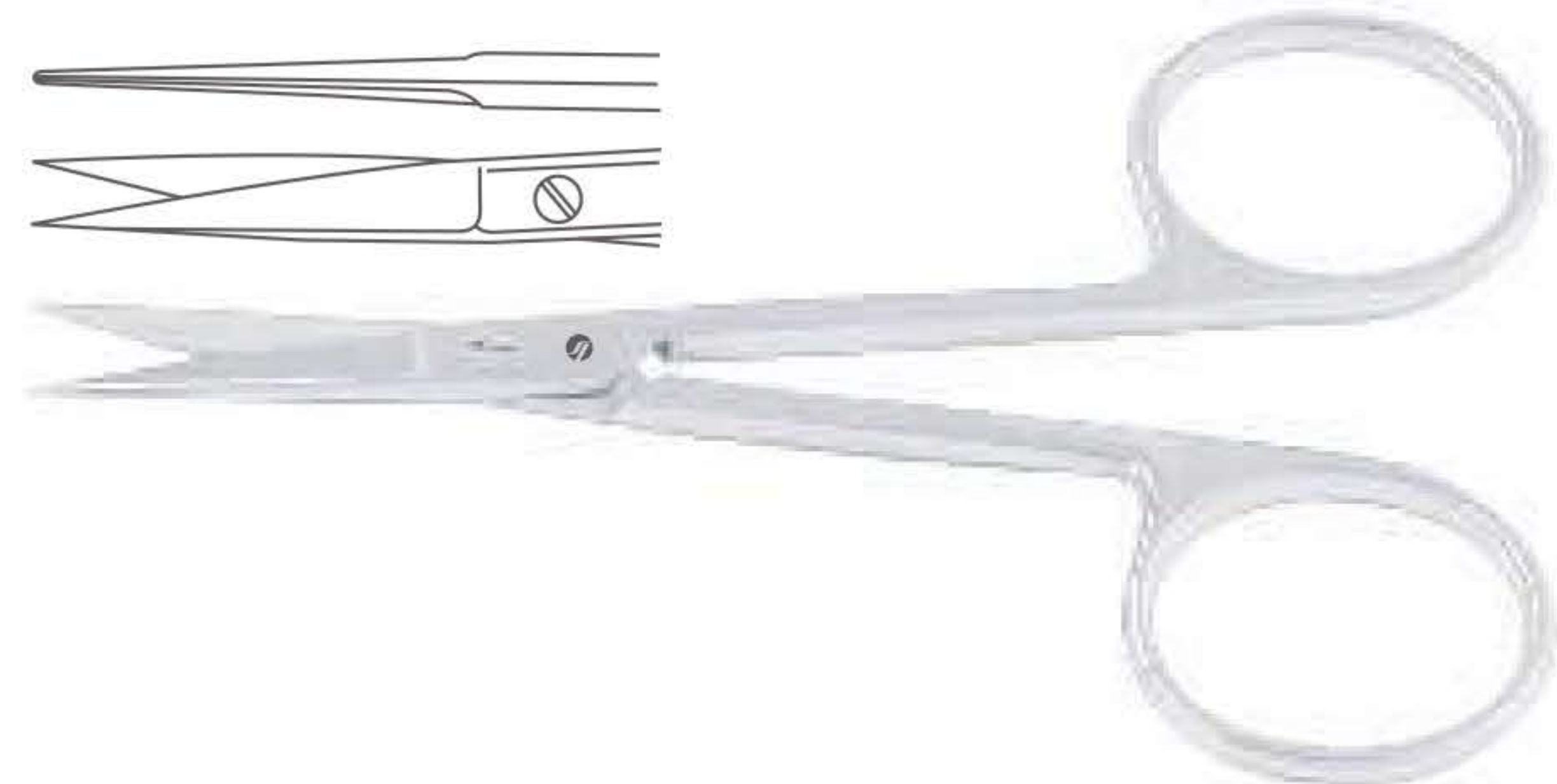

Catalog #	Size
SS-432-10	10 cm (4")

**Bonn Iris Scissor**  
 Straight



Catalog #	Size
SS-434-09	9 cm (3 1/2")

Iris Scissors  
 Irisscheren  
 Tijeras para iridectomía  
 Ciseaux à iridectomie  
 Forbici per iridectomia

**Bonn Iris Scissor**  
 Curved

Catalog #	Size
SS-435-09	9 cm (3 1/2")



**Iris Scissor**  
 Straight

Catalog #	Size
SS-440-11	11.5 cm (4 1/2")



**Iris Scissor**  
 Straight

**SUPER Edge™**

Catalog #	Size
SS-440-11 SC	11.5 cm (4 1/2")



**Iris Scissor**  
 Curved

Catalog #	Size
SS-441-11	11.5 cm (4 1/2")



**Iris Scissor**  
 Curved

Catalog #	Size
SS-441-11 SC	11.5 cm (4 1/2")



Iris Scissors  
 Irisscheren  
 Tijeras para iridectomía  
 Ciseaux à iridectomie  
 Forbici per iridectomia

**Iris Scissor**  
 Curved to Side

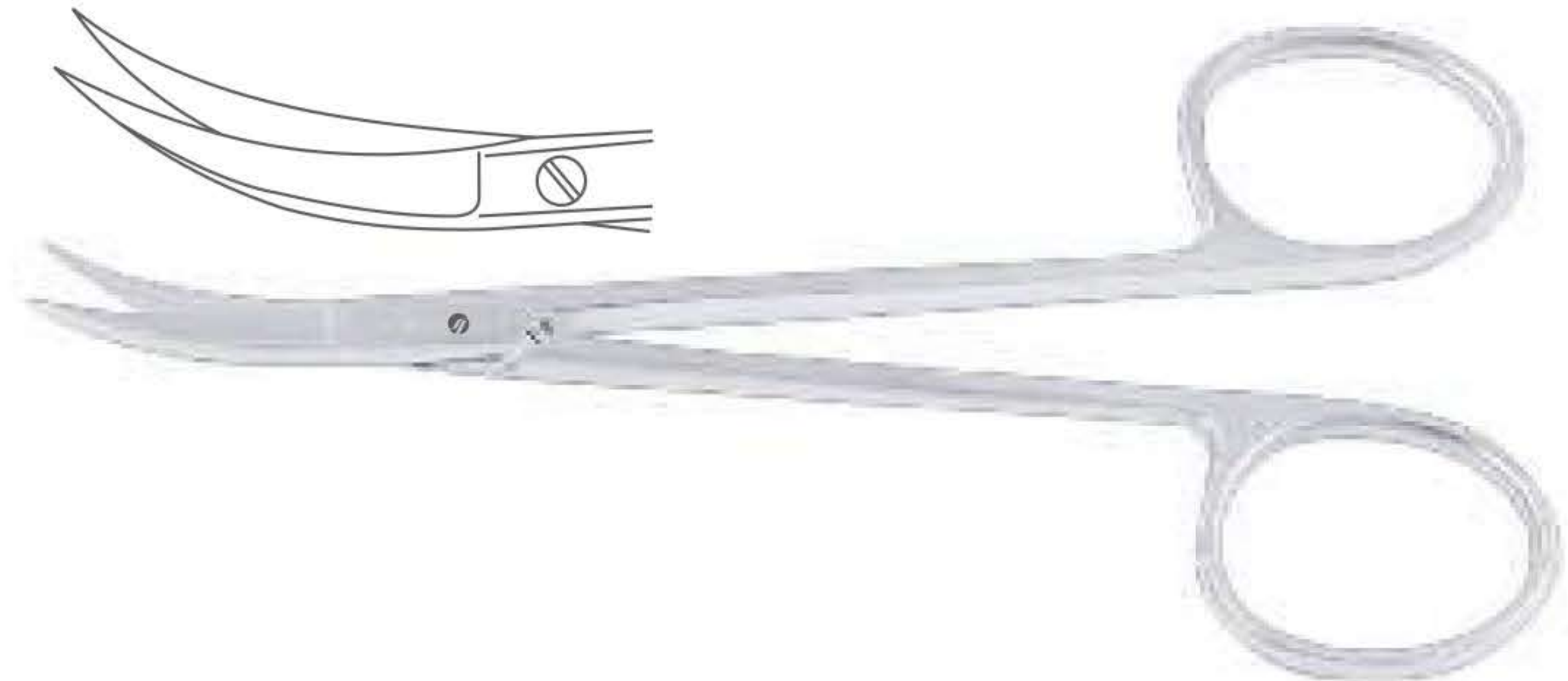

Catalog #	Size
SS-443-11	11.5 cm (4 1/2")

**Iris Scissor**  
 Angled

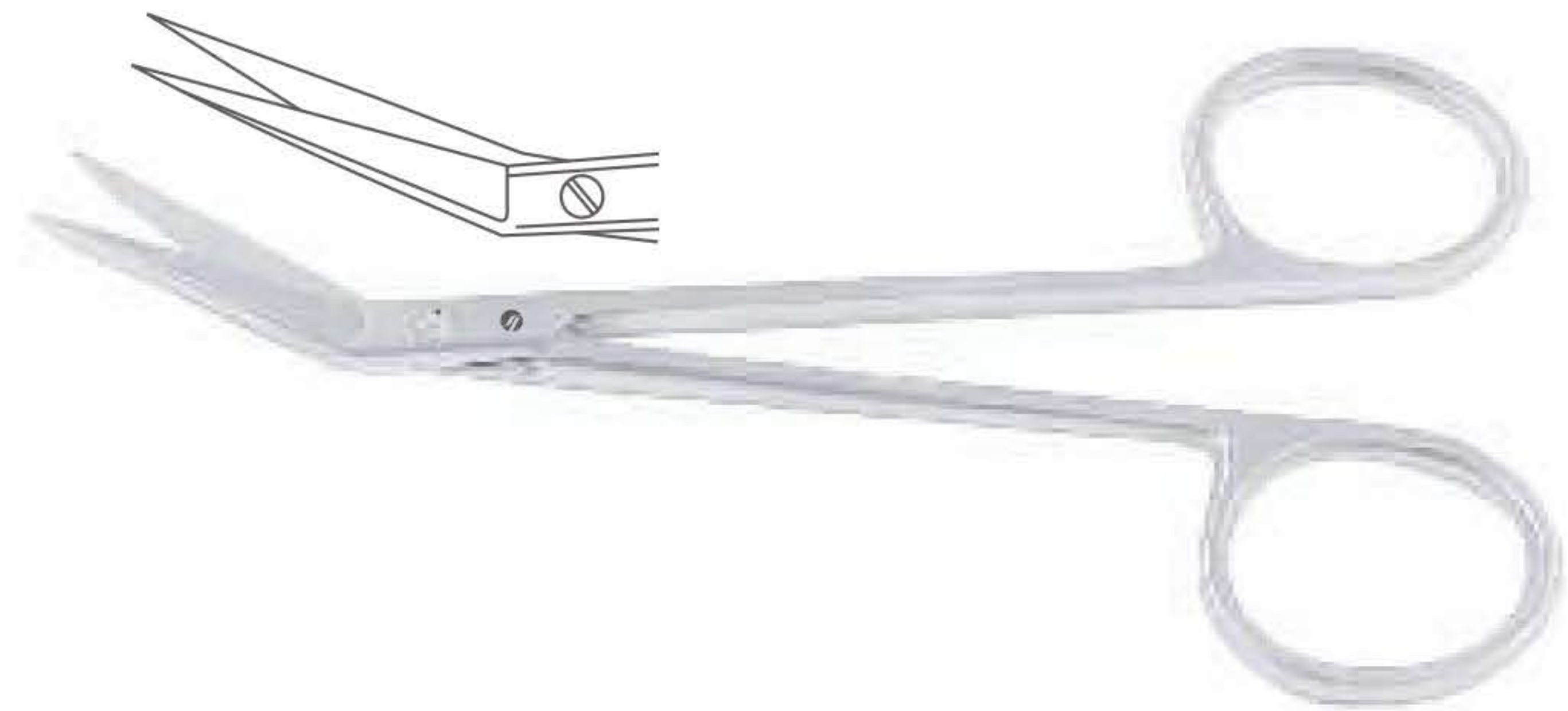

Catalog #	Size
SS-445-11	11.5 cm (4 1/2")

**Iris Scissor**  
 Straight

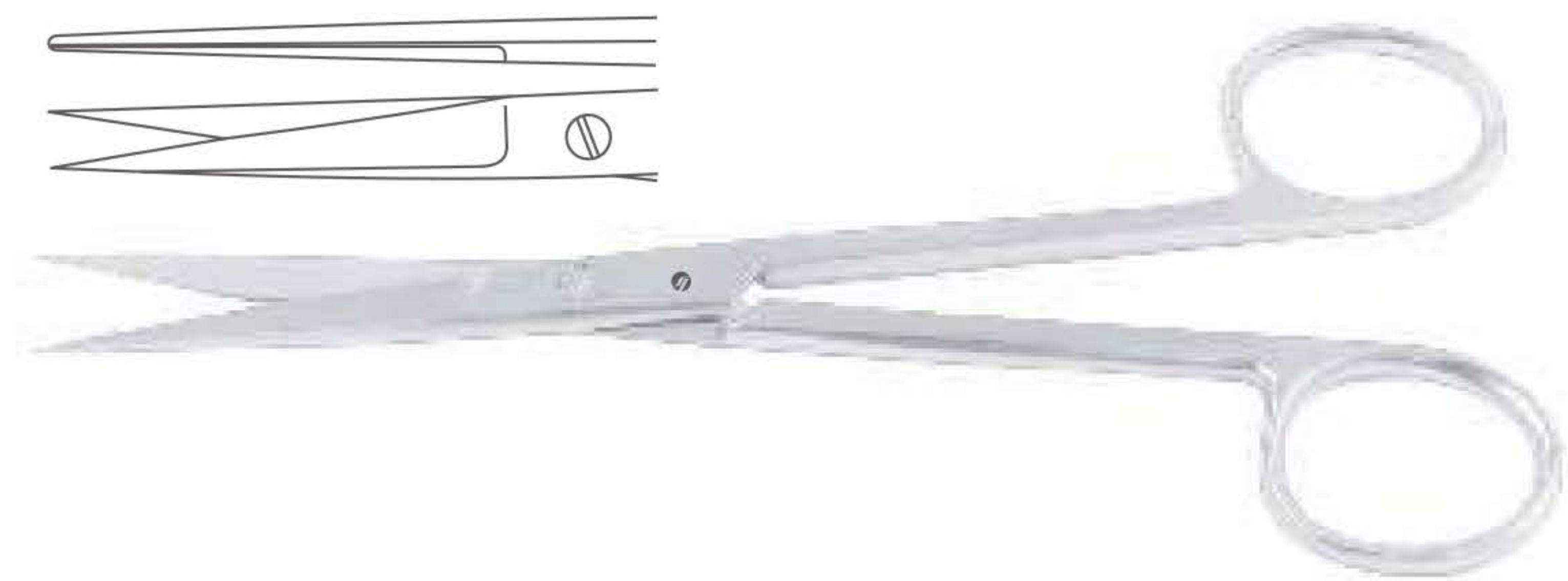

Catalog #	Size
SS-446-12	12.5 cm (5")

**Iris Scissor**  
 Curved

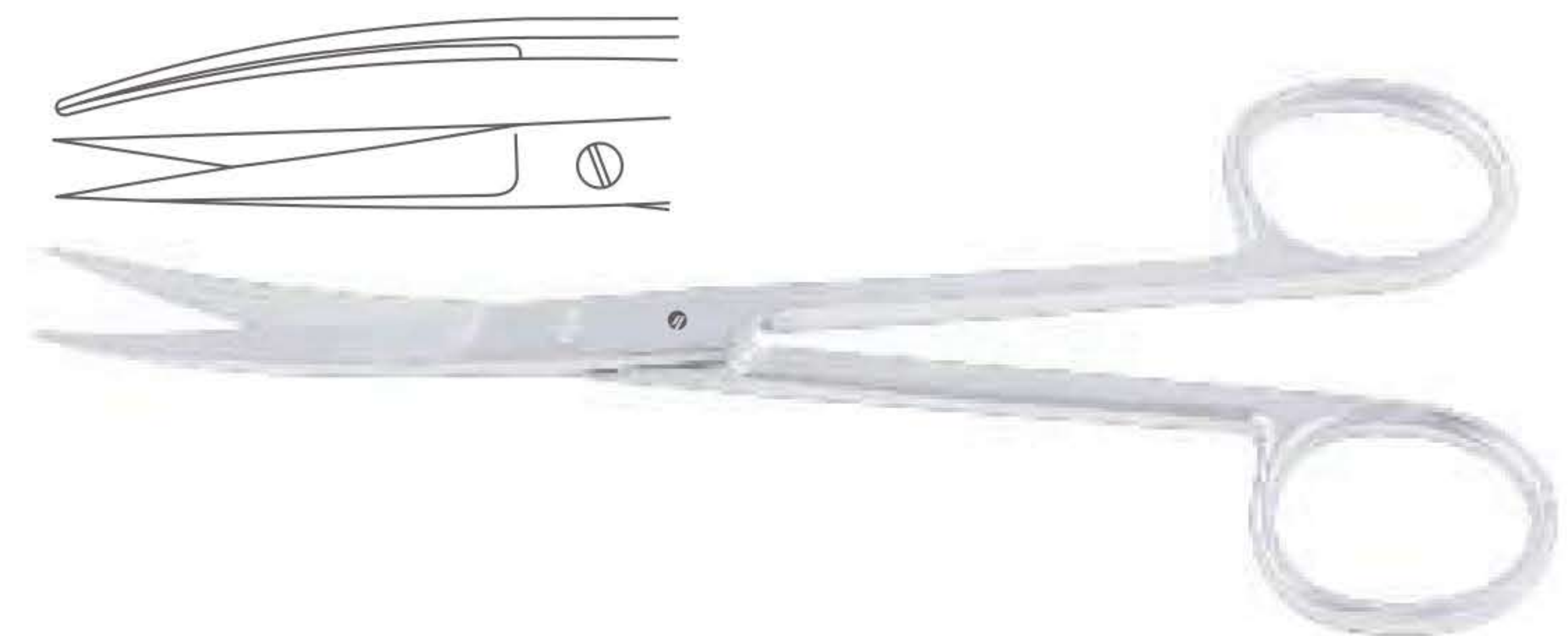

Catalog #	Size
SS-447-12	12.5 cm (5")

**Stevens Tenotomy Scissor**  
 Straight, Sharp/Sharp

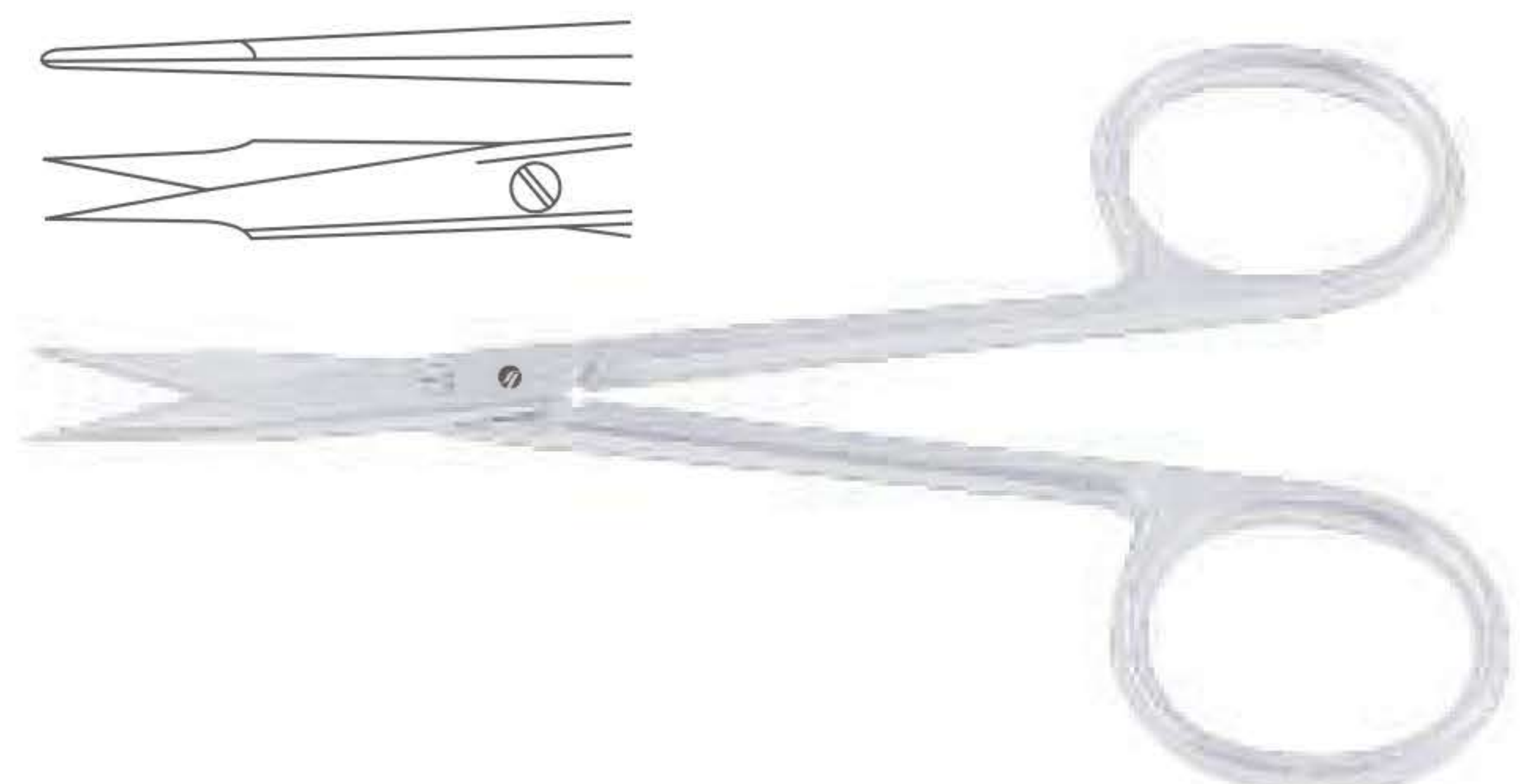

Catalog #	Size
SS-450-10	10 cm (4")
SS-450-11	11 cm (4 1/2")