

# **NJ** ENTERPRISES

Block # 4, Rashid Minhas Road, Small Industries Estate Sialkot - Pakistan.

Whatsapp: Mob: 0092 333 8733922  
Phone: 0092 52 3257502  
Fax: 0092 52 3257501

E-mail: [akif@nj-ent.co](mailto:akif@nj-ent.co)  
[njenterprisespk@yahoo.com](mailto:njenterprisespk@yahoo.com)  
Website: [www.nj-ent.com](http://www.nj-ent.com)



# Gynecology

Instruments

Vaginal Specula  
 Vaginalspekula  
 Espéculos vaginales  
 Spéculums vaginaux  
 Specoli vaginali

**Cusco Vaginal Speculum**

Catalog #	Blade Size
GY-011-01	75 x 32 mm
GY-011-02	85 x 35 mm
GY-011-03	100 x 35 mm



**Cusco(Virgin) Vaginal Speculum**

Catalog #	Blade Size
GY-013-01	75 x 18 mm



**Cusco Vaginal Speculum**

Catalog #	Blade Size
GY-015-01	80 x 22 mm
GY-015-02	100 x 25 mm
GY-015-03	105 x 27 mm



**Cusco Vaginal Speculum**

Catalog #	Blade Size
GY-017-01	75 x 34 mm
GY-017-02	85 x 37 mm
GY-017-03	100 x 37 mm



Vaginal Specula  
 Vaginalspekula  
 Espéculos vaginales  
 Spéculums vaginaux  
 Specoli vaginali

**Collin Vaginal Speculum**

Catalog #	Blade Size
GY-021-01	85 x 30 mm
GY-021-02	100 x 35 mm
GY-021-03	110 x 40 mm



**Pederson Vaginal Speculum**

Catalog #	Blade Size
GY-031-01	75 x 13 mm
GY-031-02	100 x 22 mm
GY-031-03	120 x 25 mm



**Grave Vaginal Speculum**

Catalog #	Blade Size
GY-041-01	75 x 20 mm
GY-041-02	95 x 35 mm
GY-041-03	115 x 35 mm



**Semm Vaginal Speculum**

Catalog #	Blade Size
GY-051-01	100 x 20 - 25 mm
GY-051-02	105 x 27 - 35 mm



Vaginal Specula  
 Vaginalsepekula  
 Espéculos vaginales  
 Spéculums vaginaux  
 Specoli vaginali

**Sims Vaginal Speculum**

Set of 3 Ref: GY-061-01 to GY-061-03

Catalog #	Size
GY-061-00	Standard



**Sims Vaginal Speculum**

Catalog #	Blade Size, Profile
GY-061-01	65 x 25 mm / 70 x 30 mm
GY-061-02	70 x 30 mm / 70 x 35 mm
GY-061-03	85 x 35 mm / 90 x 40 mm



**Jackson Vaginal Speculum**

Catalog #	Blade Size
GY-065-01	75 x 38 mm
GY-065-02	90 x 38 mm
GY-065-03	100 x 38 mm



**Kristeller Vaginal Speculum**

Catalog #	Blade Size
GY-071-01	70 x 27 mm
GY-071-02	80 x 30 mm
GY-071-03	90 x 36 mm



Vaginal Specula, Vaginal Retractors  
 Vaginalspekula, Scheidenhalter  
 Espéculos vaginales, Valvas vaginales  
 Spéculums vaginaux, Valves vaginales  
 Specoli vaginali, Valve vaginali

**Kristeller Vaginal Retractor**

Catalog #	Blade Size
GY-081-01	75 x 23 mm
GY-081-02	85 x 26 mm
GY-081-03	100 x 32 mm



**Kristeller Vaginal Specula**

Set of Ref:- GY-071-01 and GY-081-01

Catalog #	Size
GY-091-01	Standard



**Kristeller Vaginal Specula**

Set of Ref:- GY-071-02 and GY-081-02

Catalog #	Size
GY-091-02	Standard



**Kristeller Vaginal Specula**

Set of Ref:- GY-071-03 and GY-081-03

Catalog #	Size
GY-091-03	Standard



**Kristeller Vaginal Speculum**

Slender Pattern

Catalog #	Blade Size
GY-101-01	105 x 18 mm
GY-101-02	105 x 21 mm



Vaginal Specula, Vaginal Retractors  
 Vaginalsepekula, Scheidenhalter  
 Espéculos vaginales, Valvas vaginales  
 Spéculum vaginaux, Valves vaginales  
 Specoli vaginali, Valve vaginali

**Kristeller Vaginal Retractor**  
 Slender Pattern

Catalog #	Blade Size
GY-111-01	110 x 14 mm
GY-111-02	110 x 17 mm

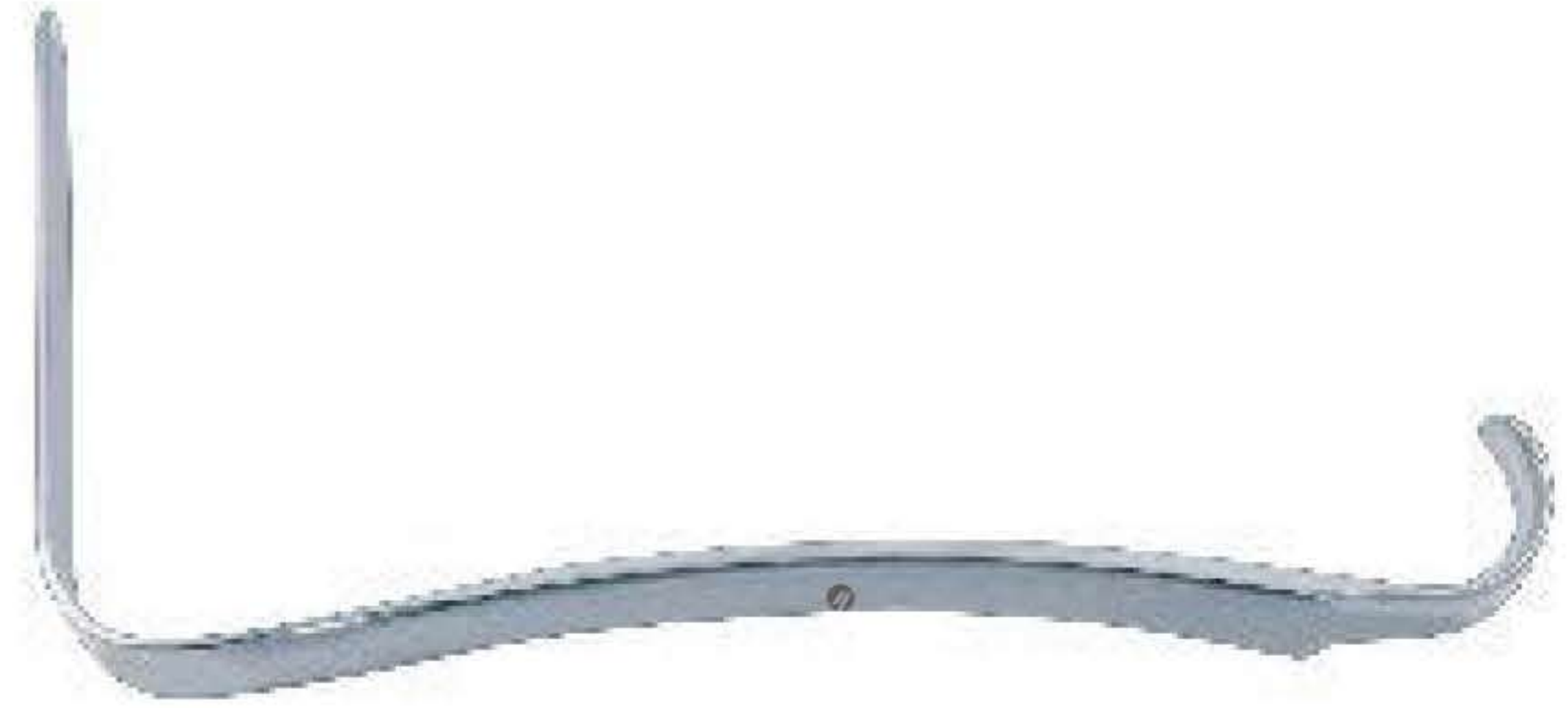

**Kristeller Vaginal Specula**  
 Set of 2 Ref:- GY-101-01 and GY-111-01

Catalog #	Size
GY-121-01	Standard



**Kristeller Vaginal Specula**  
 Set of 2 Ref:- GY-101-02 and GY-111-02

Catalog #	Size
GY-121-02	Standard



**Kristeller Vaginal Speculum**

Catalog #	Blade Size
GY-131-01	105 x 26 mm
GY-131-02	105 x 28 mm
GY-131-03	105 x 33 mm



**Kristeller Vaginal Retractor**

Catalog #	Blade Size
GY-141-01	115 x 22 mm
GY-141-02	115 x 24 mm
GY-141-03	115 x 29 mm



Vaginal Specula, Vaginal Retractors  
 Vaginalspekula, Scheidenhalter  
 Espéculos vaginales, Valvas vaginales  
 Spéculums vaginaux, Valves vaginales  
 Specoli vaginali, Valve vaginali

**Kristeller Vaginal Specula**

Set of 2 Ref:- GY-131-01 and GY-141-01

Catalog #	Size
GY-151-01	Standard



**Kristeller Vaginal Specula**

Set of 2 Ref:- GY-131-02 and GY-141-02

Catalog #	Size
GY-151-02	Standard



**Kristeller Vaginal Specula**

Set of 2 Ref:- GY-131-03 and GY-0141-03

Catalog #	Size
GY-151-03	Standard



**Kristeller Vaginal Speculum**

Catalog #	Blade Size
GY-161-01	110 x 27 mm
GY-161-02	110 x 30 mm
GY-161-03	110 x 36 mm

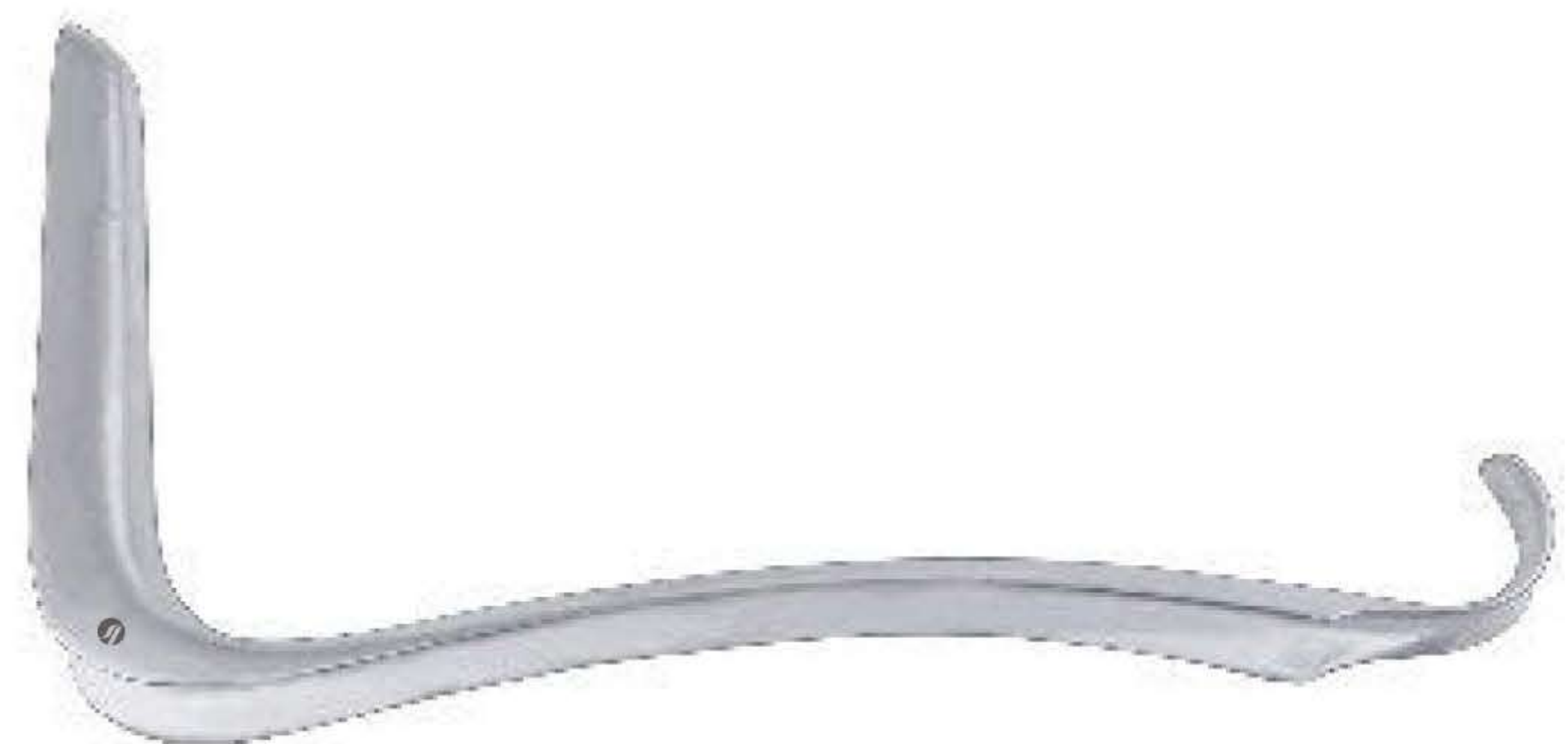

**Kristeller Vaginal Retractor**

Catalog #	Blade Size
GY-171-01	115 x 23 mm
GY-171-02	115 x 26 mm
GY-171-03	115 x 32 mm

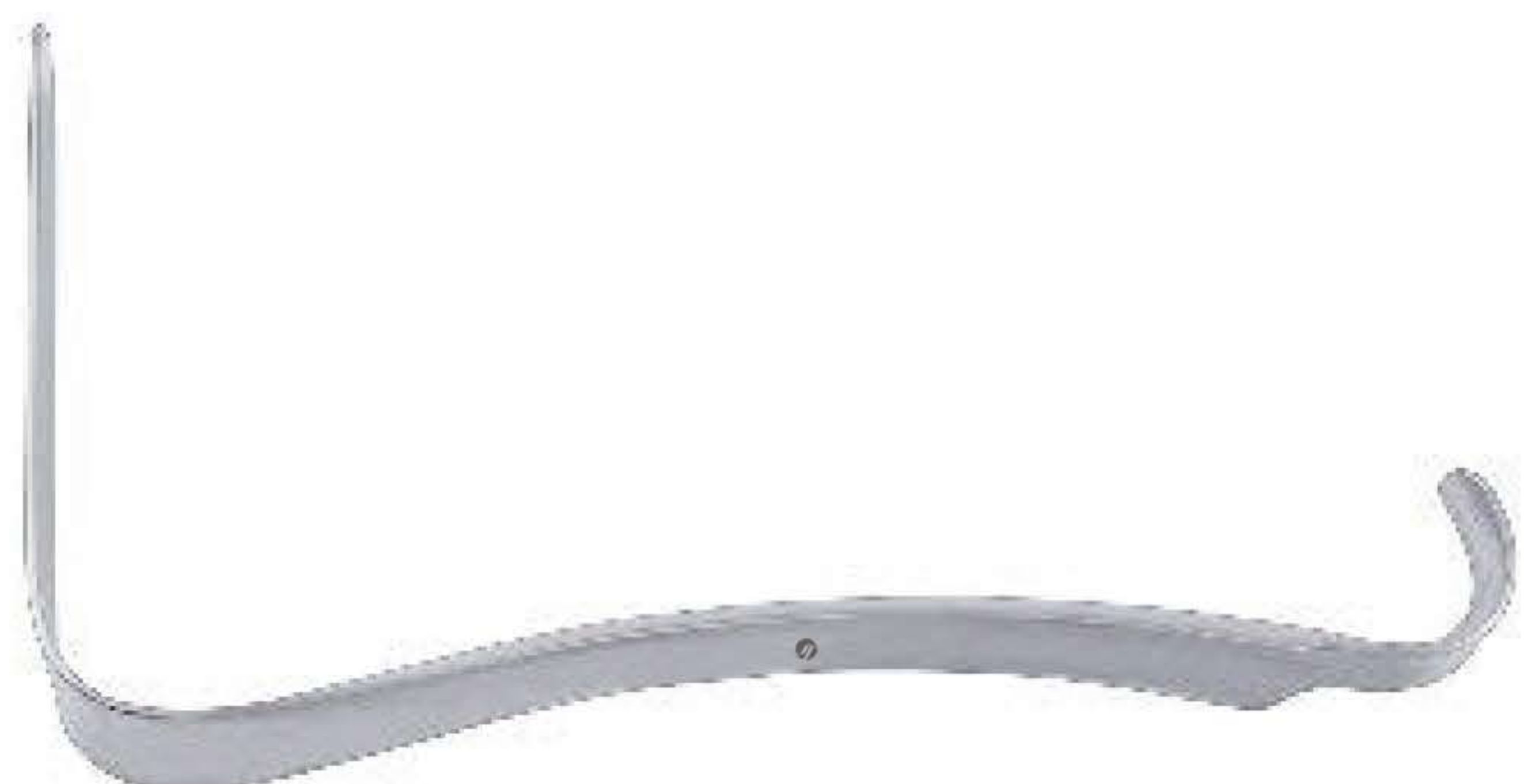

Vaginal Specula, Vaginal Retractors  
 Vaginalsepekula, Scheidenhalter  
 Espéculos vaginales, Valvas vaginales  
 Spéculums vaginaux, Valves vaginales  
 Specoli vaginali, Valve vaginali

**Kristeller Vaginal Specula**

Set of 2 Ref:- GY-161-01 and GY-171-01

Catalog #	Size
GY-181-01	Standard



**Kristeller Vaginal Specula**

Set of 2 Ref:- GY-161-02 and GY-171-02

Catalog #	Size
GY-181-02	Standard



**Kristeller Vaginal Specula**

Set of 2 Ref:- GY-161-03 and GY-171-03

Catalog #	Size
GY-181-03	Standard



**Kallmorgen Vaginal Specula**

Catalog #	Blade Size
GY-201-01	70 x 40 mm
GY-201-02	90 x 40 mm

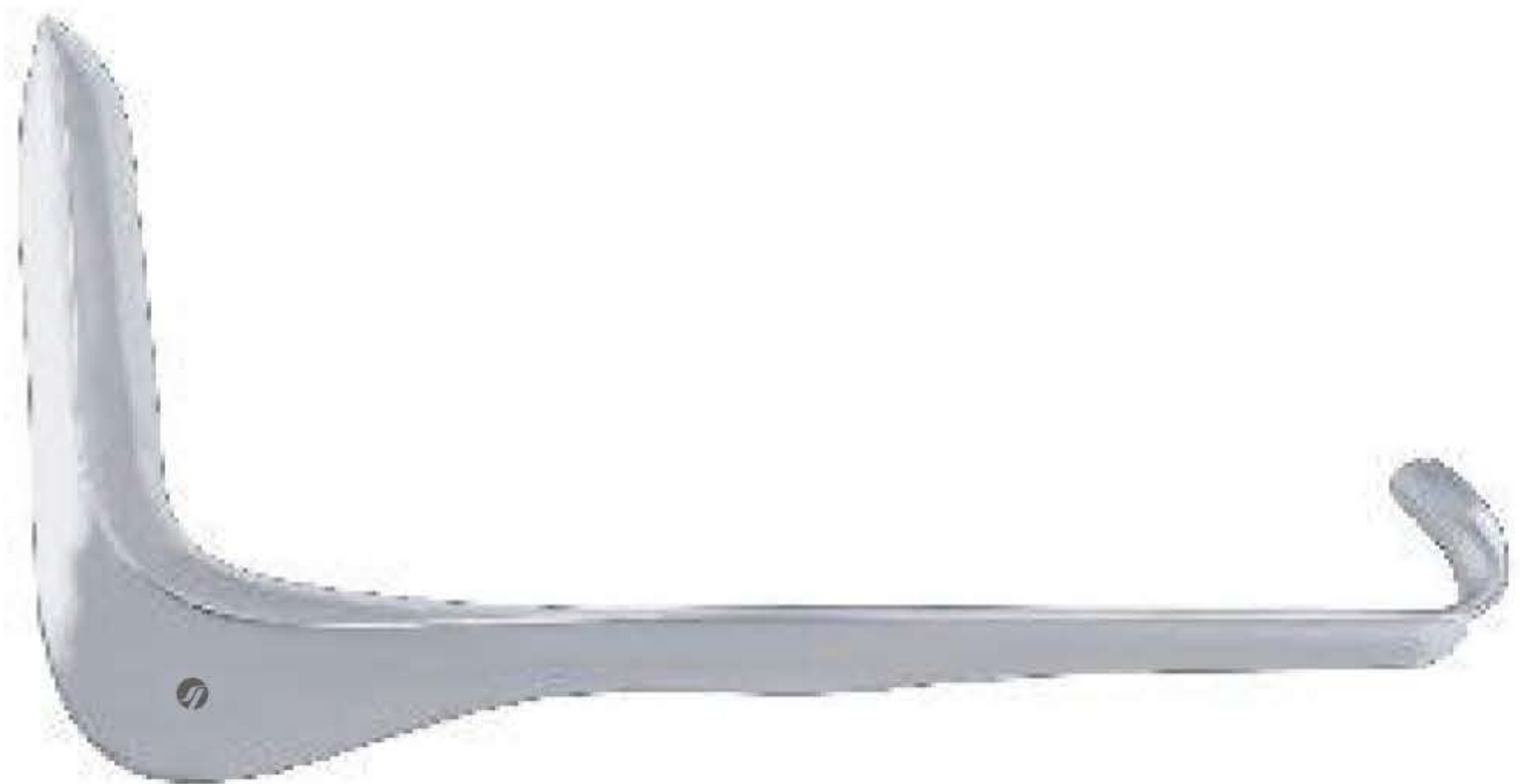

**Kallmorgen Vaginal Retractor**

Catalog #	Blade Size
GY-211-01	70 x 33 mm
GY-211-02	90 x 33 mm

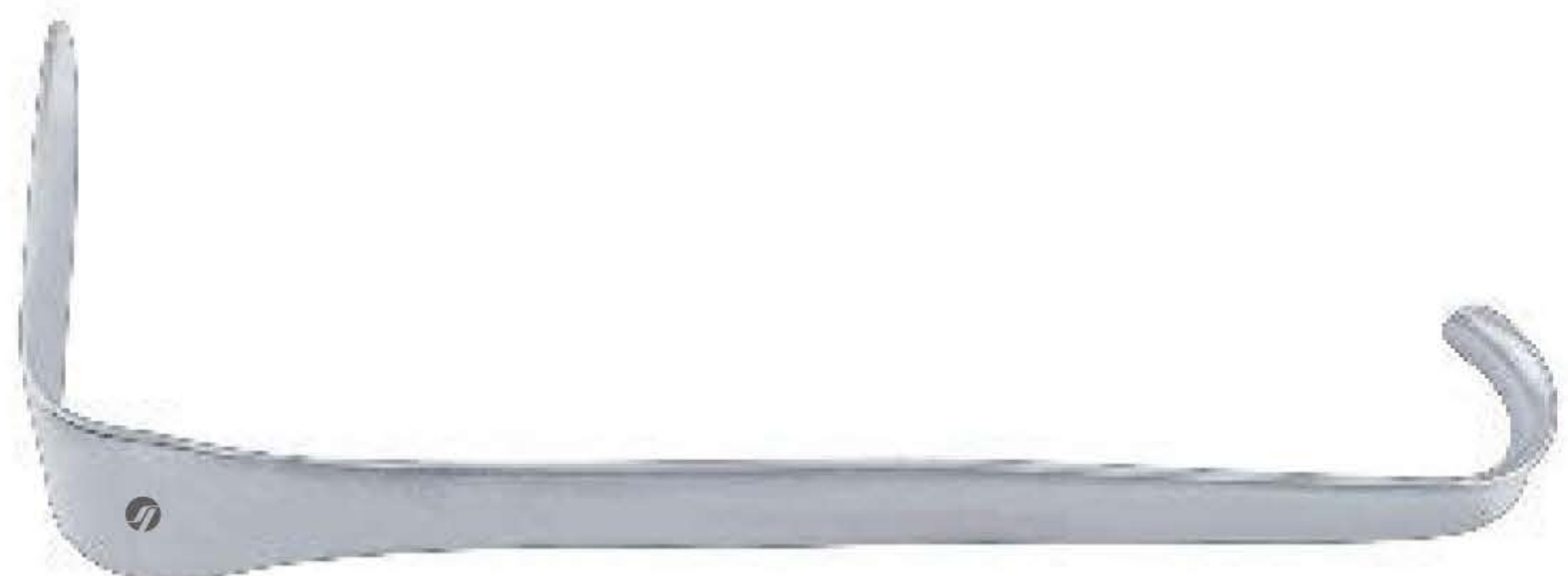

Vaginal Specula, Vaginal Retractors  
 Vaginalspekula, Scheidenhalter  
 Espéculos vaginales, Valvas vaginales  
 Spéculums vaginaux, Valves vaginales  
 Specoli vaginali, Valve vaginali

**Kallmorgen Vaginal Specula**

Set of 2 Ref:- GY-201-01 and GY-211-01

Catalog #	Size
GY-221-01	Standard

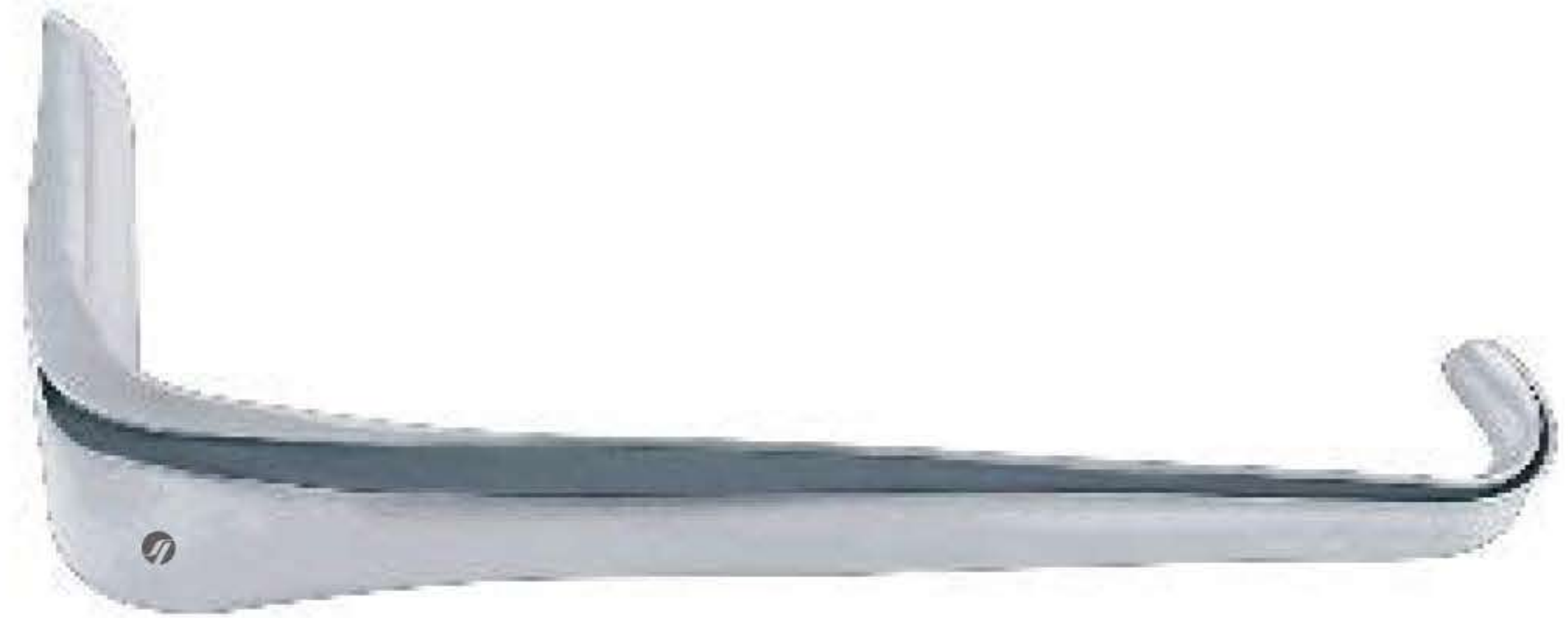

**Kallmorgen Vaginal Specula**

Set of 2 Ref:- GY-201-02 and GY-211-02

Catalog #	Size
GY-221-02	Standard

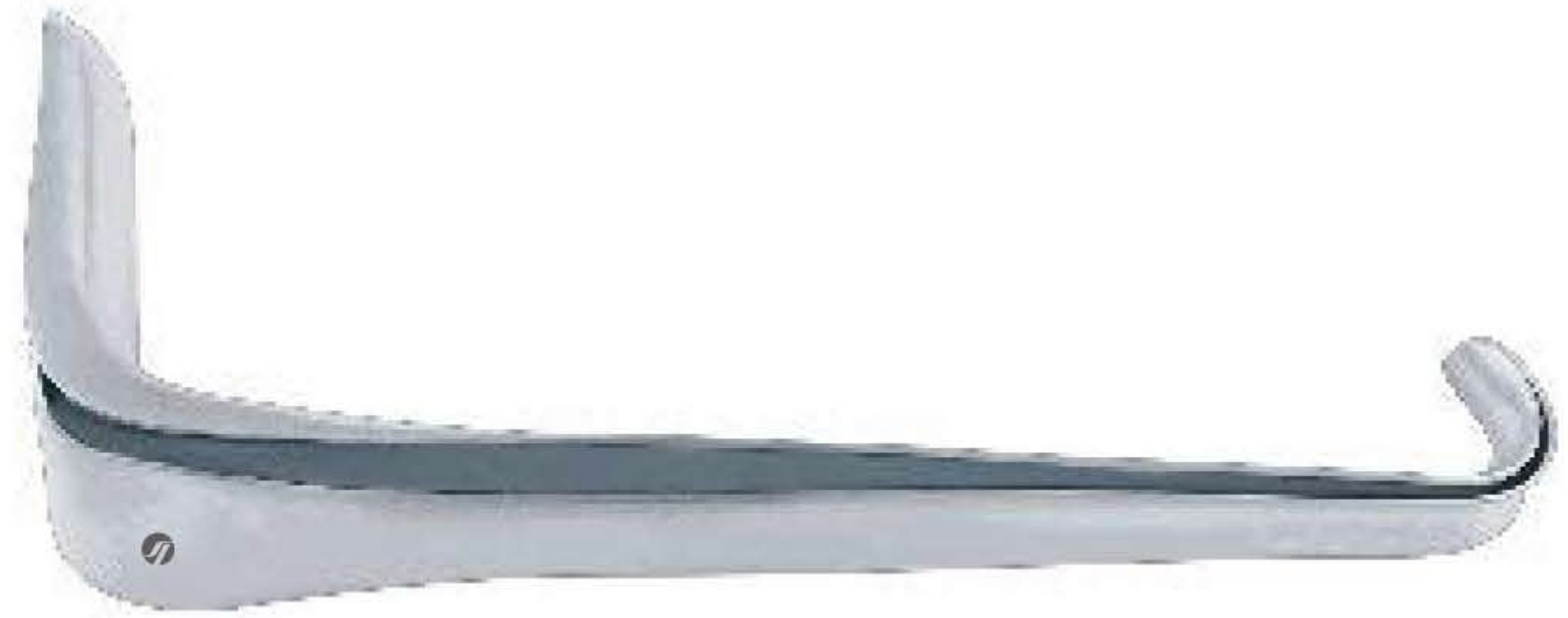

**Doyen Vaginal Speculum**

Slightly Concave

Catalog #	Blade Size
GY-231-01	63 x 35 mm
GY-231-02	94 x 35 mm
GY-231-03	124 x 35 mm



**Doyen Vaginal Speculum**

Slightly Concave

Catalog #	Blade Size
GY-233-01	66 x 47 mm
GY-233-02	95x 47 mm
GY-233-03	126 x 47 mm
GY-233-04	160 x 47 mm



Vaginal Specula, Vaginal Retractors  
 Vaginalspekula, Scheidenhalter  
 Espéculos vaginales, Valvas vaginales  
 Spéculums vaginaux, Valves vaginales  
 Specoli vaginali, Valve vaginali

**Doyen Vaginal Speculum**  
 Slightly Concave

Catalog #	Blade Size
GY-235-01	55 x 60 mm
GY-235-02	95 x 60 mm
GY-235-03?	130 x 60 mm
GY-235-04	175 x 60 mm



**Scherbak Vaginal Specula Complete**  
 With 5 Blades Blades Ref:- GY-251-01 to GY-251-05

Catalog #	Size
GY-251-00	N/A



**Scherbak Specula Blade**

Catalog #	Blade Size
GY-251-01	80 x 30 mm
GY-251-02	85 x 35 mm
GY-251-03	90 x 40 mm
GY-251-04	62 x 40 - 60 mm
GY-251-05	81 x 45 - 70 mm



GY-251-01  
 GY-251-02  
 GY-251-03



GY-251-04  
 GY-251-05

**Scherbak Weight**  
 Weight for Vaginal Speculum

Catalog #	Weight
GY-251-81	400 Grams
GY-251-82	800 Grams



Vaginal Specula, Vaginal Retractors  
 Vaginalspekula, Scheidenhalter  
 Espéculos vaginales, Valvas vaginales  
 Spéculums vaginaux, Valves vaginales  
 Specoli vaginali, Valve vaginali

**Scherbak Vaginal Speculum**  
 Handle Only



Catalog #	Size
GY-251-90	20 cm (8")

**Auvard Vaginal Specula Complete**  
 With Detachable Weight



Catalog #	Size, Blade Size
GY-261-23	23.5 cm (9 1/4"), 80 x 43 mm

**Breisky Vaginal Specula**



Catalog #	Size, Blade Size
GY-271-20	29.5 cm (11 1/2"), 100 x 20 mm
GY-271-25	29.5 cm (11 1/2"), 100 x 25 mm
GY-271-30	29.5 cm (11 1/2"), 100 x 30 mm
GY-271-35	29.5 cm (11 1/2"), 100 x 35 mm
GY-271-40	29.5 cm (11 1/2"), 100 x 40 mm

**Breisky Vaginal Specula**



Catalog #	Size, Blade Size
GY-273-20	32 cm (12 1/2"), 130 x 20 mm
GY-273-25	32 cm (12 1/2"), 130 x 25 mm
GY-273-30	32 cm (12 1/2"), 130 x 30 mm
GY-273-35	32 cm (12 1/2"), 130 x 35 mm
GY-273-40	32 cm (12 1/2"), 130 x 40 mm

Endocervical Specula, Uterine Dilators  
 Endospekula, Uterusdilatoren  
 Espéculos endocervicales, Dilatadores uterinos  
 Endospéculums, Dilatateurs du col de l'utérus  
 Endospecoli, Dilatatori uterini

**Breisky Vaginal Specula**



Catalog #	Size, Blade Size
GY-275-40	35 cm (13 3/4"), 160 x 40 mm

**Landau Vaginal Specula**



Catalog #	Size, Blade Size
GY-277-01	29 cm (11 1/2"), 100 x 28 mm
GY-277-02	29 cm (11 1/2"), 100 x 38 mm

**Doyen Vaginal Retractor**



Catalog #	Size, Blade Size
GY-281-24	25 cm (9 3/4"), 70 x 30 mm

**Kogan Endocervical Specula**



Catalog #	Size
GY-301-24	24.5 cm (9 3/4")

**Kogan Endocervical Specula**  
 With graduations and Fixing Screw



Catalog #	Size
GY-303-24	24.5 cm (9 3/4")

Uterine Dilators  
 Uterusdilatoren  
 Diladores uterinos  
 Dilateurs du col de l'utérus  
 Dilatori uterini

**Goodell Uterine Dilator**  
 With graduations and Fixing Screw



Catalog #	Size
GY-307-34	34 cm (13 1/2")

**Hegar Uterine Dilators**  
 Set of 14 Ref:- GY-405-04 to GY-405-17 With out Case



Catalog #	Size
GY-400-14	Standard

**Hegar Uterine Dilators**  
 Set of 26 Ref:- GY-405-01 to GY-405-26 With out Case



Catalog #	Size
GY-400-26	Standard

**Hegar Uterine Dilators**  
 Set of 14 Ref:- GY-405-04 to GY-405-17 With Metal Case

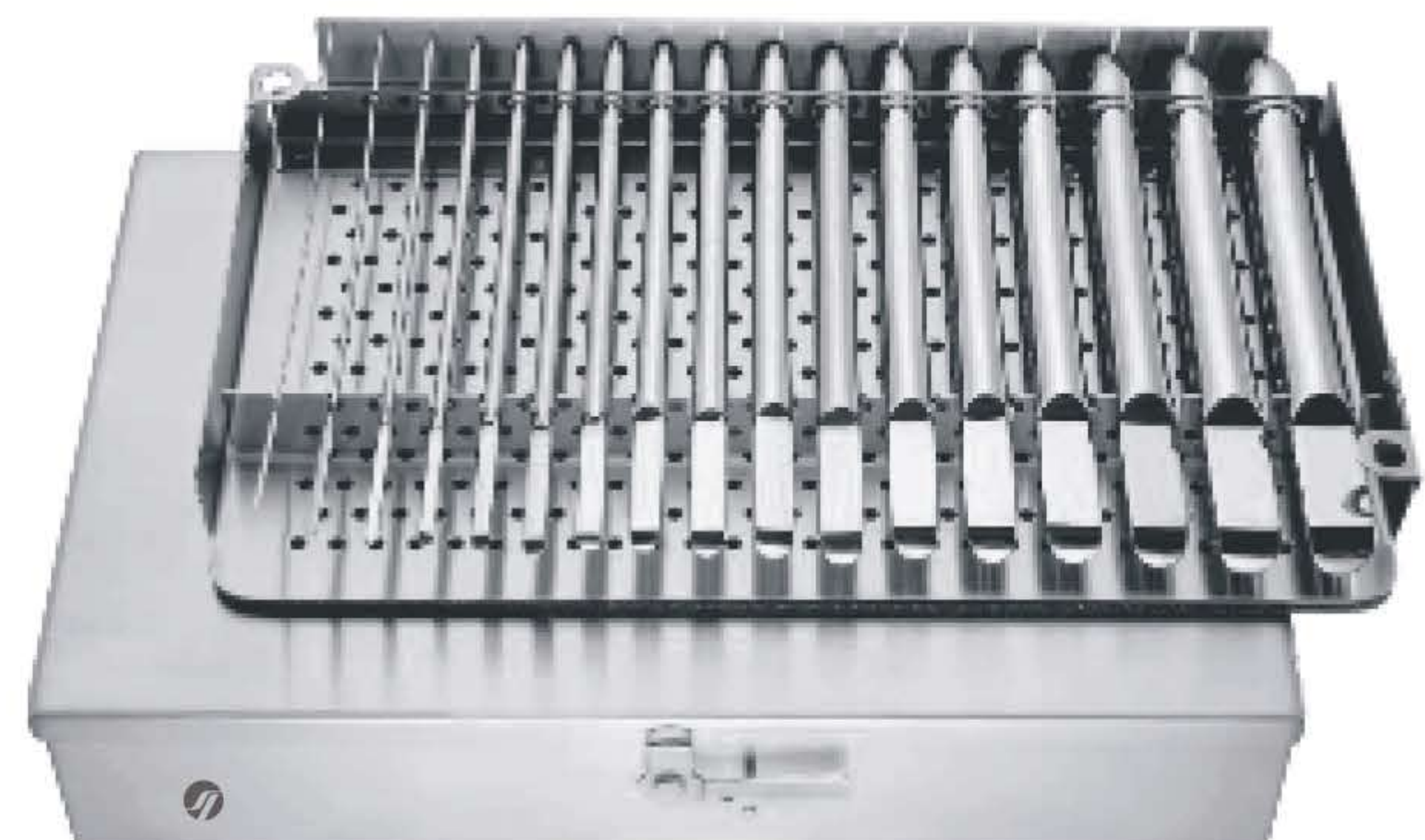

Catalog #	Size
GY-402-14	Standard

Uterine Dilators  
 Uterusdilatoren  
 Diladores uterinos  
 Dilateurs du col de l'utérus  
 Dilatori uterini

**Hegar Uterine Dilator**  
 Single Ended

Catalog #	Size, Diameter
GY-405-01	18.5cm (7 1/4"), Ø 1.0 mm
GY-405-02	18.5cm (7 1/4"), Ø 2.0 mm
GY-405-03	18.5cm (7 1/4"), Ø 3.0 mm
GY-405-04	18.5cm (7 1/4"), Ø 4.0 mm
GY-405-05	18.5cm (7 1/4"), Ø 5.0 mm
GY-405-06	18.5cm (7 1/4"), Ø 6.0 mm
GY-405-07	18.5cm (7 1/4"), Ø 7.0 mm
GY-405-08	18.5cm (7 1/4"), Ø 8.0 mm
GY-405-09	18.5cm (7 1/4"), Ø 9.0 mm
GY-405-10	18.5cm (7 1/4"), Ø 10.0 mm
GY-405-11	18.5cm (7 1/4"), Ø 11.0 mm
GY-405-12	18.5cm (7 1/4"), Ø 12.0 mm
GY-405-13	18.5cm (7 1/4"), Ø 13.0 mm
GY-405-14	18.5cm (7 1/4"), Ø 14.0 mm
GY-405-15	18.5cm (7 1/4"), Ø 15.0 mm
GY-405-16	18.5cm (7 1/4"), Ø 16.0 mm
GY-405-17	18.5cm (7 1/4"), Ø 17.0 mm
GY-405-18	18.5cm (7 1/4"), Ø 18.0 mm
GY-405-19	18.5cm (7 1/4"), Ø 19.0 mm
GY-405-20	18.5cm (7 1/4"), Ø 20.0 mm
GY-405-21	18.5cm (7 1/4"), Ø 21.0 mm
GY-405-22	18.5cm (7 1/4"), Ø 22.0 mm
GY-405-23	18.5cm (7 1/4"), Ø 23.0 mm
GY-405-24	18.5cm (7 1/4"), Ø 24.0 mm
GY-405-25	18.5cm (7 1/4"), Ø 25.0 mm
GY-405-26	18.5cm (7 1/4"), Ø 26.0 mm



Uterine Dilators  
 Uterusdilatoren  
 Dilatadores uterinos  
 Dilatateurs du col de l'utérus  
 Dilatatori uterini

**Hegar Uterine Dilator**  
 Single Ended

Catalog #	Size, Diameter
GY-407-01	18.5cm (7 1/4"), Ø 1.5 mm
GY-407-02	18.5cm (7 1/4"), Ø 2.5 mm
GY-407-03	18.5cm (7 1/4"), Ø 3.5 mm
GY-407-04	18.5cm (7 1/4"), Ø 4.5 mm
GY-407-05	18.5cm (7 1/4"), Ø 5.5 mm
GY-407-06	18.5cm (7 1/4"), Ø 6.5 mm
GY-407-07	18.5cm (7 1/4"), Ø 7.5 mm
GY-407-08	18.5cm (7 1/4"), Ø 8.5 mm
GY-407-09	18.5cm (7 1/4"), Ø 9.5 mm
GY-407-10	18.5cm (7 1/4"), Ø 10.5 mm
GY-407-11	18.5cm (7 1/4"), Ø 11.5 mm
GY-407-12	18.5cm (7 1/4"), Ø 12.5 mm
GY-407-13	18.5cm (7 1/4"), Ø 13.5 mm
GY-407-14	18.5cm (7 1/4"), Ø 14.5 mm
GY-407-15	18.5cm (7 1/4"), Ø 15.5 mm
GY-407-16	18.5cm (7 1/4"), Ø 16.5 mm
GY-407-17	18.5cm (7 1/4"), Ø 17.5 mm



**Hegar Uterine Dilators**  
 Set of 8 Ref:- GY-415-04 to GY-415-18 Without Case

Catalog #	Size
GY-410-08	Standard



**Hegar Uterine Dilators**  
 Set of 8 Ref:- GY-415-04 to GY-415-18 With Canvas Roll

Catalog #	Size
GY-412-08	Standard



Uterine Dilators  
 Uterusdilatoren  
 Diladores uterinos  
 Dilateurs du col de l'utérus  
 Dilatori uterini

**Hegar Uterine Dilators**

Set of 8 Ref:- GY-415-04 to GY-415-18 With Metal Case

Catalog #	Size
GY-414-08	Standard



**Hegar Uterine Dilator**

Catalog #	Size, Diameter, Profile
GY-415-02	20 cm (8"), Ø 1.0 - 2.0 mm, Fig. 1/2
GY-415-04	20 cm (8"), Ø 3.0 - 4.0 mm, Fig. 3/4
GY-415-06	20 cm (8"), Ø 5.0 - 6.0 mm, Fig. 5/6
GY-415-08	20 cm (8"), Ø 7.0 - 8.0 mm, Fig. 7/8
GY-415-10	20 cm (8"), Ø 9.0 - 10.0 mm, Fig. 9/10
GY-415-12	20 cm (8"), Ø 11.0 - 12.0 mm, Fig. 11/12
GY-415-14	20 cm (8"), Ø 13.0 - 14.0 mm, Fig. 13/14
GY-415-16	20 cm (8"), Ø 15.0 - 16.0 mm, Fig. 15/16
GY-415-18	20 cm (8"), Ø 17.0 - 18.0 mm, Fig. 17/18
GY-415-20	20 cm (8"), Ø 19.0 - 20.0 mm, Fig. 19/20
GY-415-22	20 cm (8"), Ø 21.0 - 22.0 mm, Fig. 21/22
GY-415-24	20 cm (8"), Ø 23.0 - 24.0 mm, Fig. 23/24
GY-415-26	20 cm (8"), Ø 25.0 - 26.0 mm, Fig. 25/26



**Hank Uterine Dilators**

Set of 6 Ref:- GY-425-10 to GY-425-20

Catalog #	Size
GY-420-06	Standard



Uterine Sounds, Uterine Depressor  
 Uterussonden, Uterusdepressor  
 Histerómetros, Depresor uterino  
 Hystéromètres, Dépresseur utérin  
 Isterometri, Depressore uterino

### Hank Uterine Dilator



Catalog #	Size, Diameter
GY-425-10	26.5 cm (10 1/2"), Ø 4.5 - 5.0 mm, Fig. 9/10
GY-425-12	26.5 cm (10 1/2"), Ø 5.5 - 6.0 mm, Fig. 11/12
GY-425-14	26.5 cm (10 1/2"), Ø 6.5 - 7.0 mm, Fig. 13/14
GY-425-16	26.5 cm (10 1/2"), Ø 7.5 - 8.0 mm, Fig. 15/16
GY-425-18	26.5 cm (10 1/2"), Ø 8.5 - 9.0 mm, Fig. 17/18
GY-425-20	26.5 cm (10 1/2"), Ø 9.5 - 10.0 mm, Fig. 19/20

### Sims Uterine Sound Rigid



Catalog #	Size
GY-501-32	33 cm (13")

### Sims Uterine Sound Malleable



Catalog #	Size
GY-503-32	33 cm (13")

### Valleix Uterine Sound



Catalog #	Size
GY-507-25	29.5 cm (11 1/2")

### Braun Uterine Depressor



Catalog #	Size
GY-521-27	27 cm (10 3/4")

Uterine Tenaculum Forceps  
 Hakenzangen  
 Pinza para cuello uterino  
 Pince pour le col de l'utérus  
 Pinza per il collo dell'utero

**Sims Uterine Depressor**

Catalog #	Size
GY-527-26	26 cm (10 1/4")

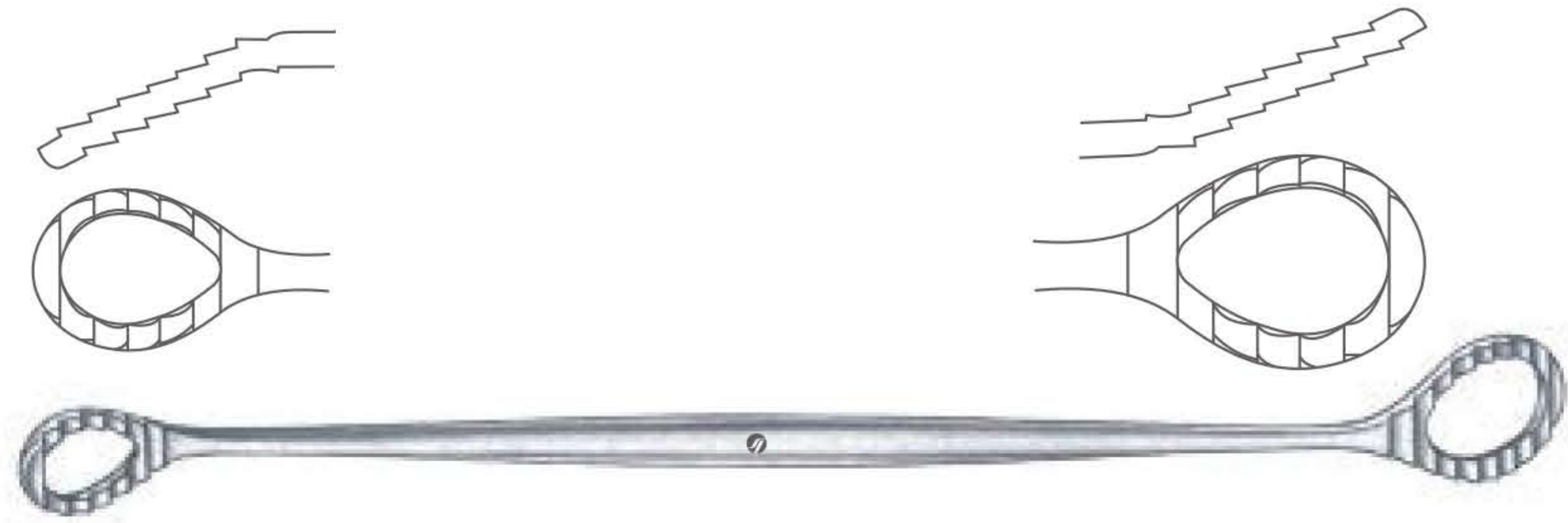

**Pozzi Tenaculum Forceps**

Catalog #	Size
GY-550-25	25.5 cm (10")



**Schroeder Tenaculum Forceps**

Catalog #	Size
GY-552-25	25.5 cm (10")



**Wilson Tenaculum Forceps**

Catalog #	Size
GY-556-24	24 cm (10 1/2")



**Braun Tenaculum Forceps**

Catalog #	Size
GY-560-26	26 cm (9 1/2")



Uterine Tenaculum Forceps  
 Hakenzangen  
 Pinza para cuello uterino  
 Pince pour le col de l'utérus  
 Pinza per il collo dell'utero

**Duplay Tenaculum Forceps**



Catalog #	Size
GY-564-28	25.5 cm (10")

**Beacham Amniotome**



Catalog #	Size
GY-571-26	26 cm (10 1/4")

**Skene Tenaculum Forcep**



Catalog #	Size
GY-581-24	24 cm (9 1/2")

**Schroeder Tenaculum Forcep**  
 Straight, 2 x 2 Teeth

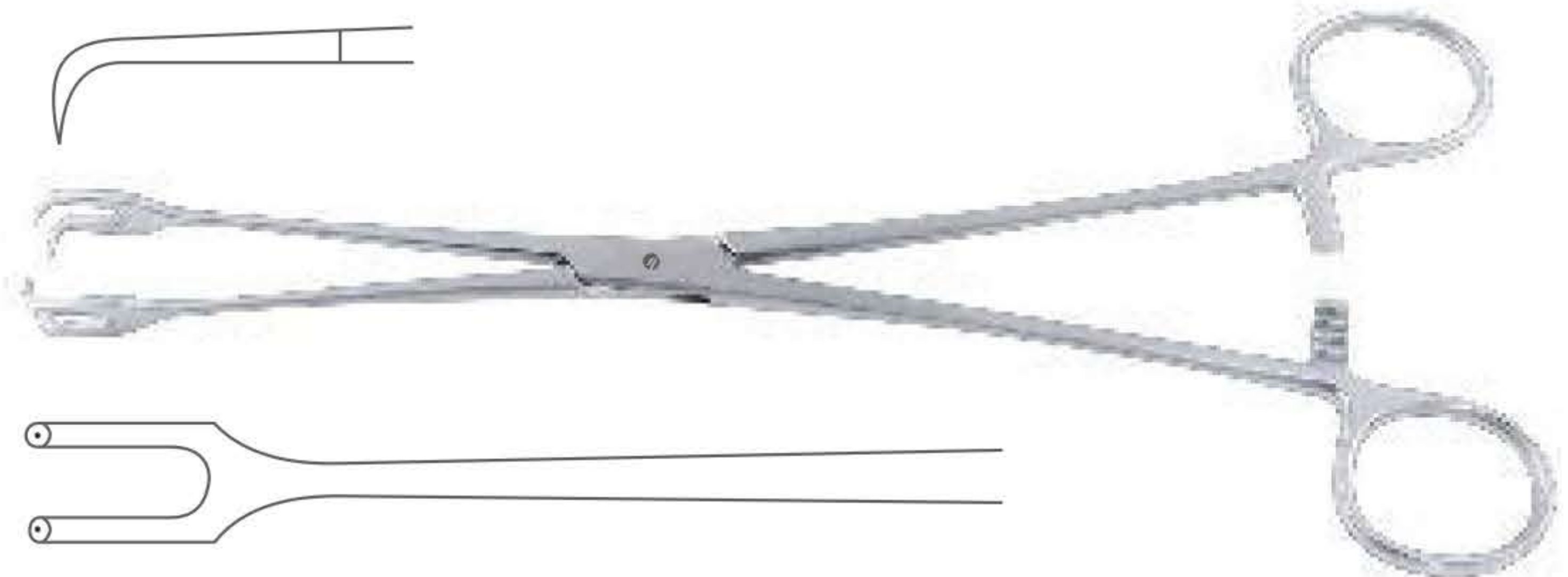

Catalog #	Size
GY-584-24	25 cm (9 3/4")

**Schroeder Tenaculum Forcep**  
 Curved, 2 x 2 Teeth



Catalog #	Size
GY-585-24	23.5 cm (9 1/4")

Uterine Tenaculum Forceps  
 Hakenzangen  
 Pinza para cuello uterino  
 Pince pour le col de l'utérus  
 Pinza per il collo dell'utero

**Schroeder Tenaculum Forcep**  
 Straight, 3 x 3 Teeth

Catalog #	Size
GY-588-27	27 cm (10 3/4")

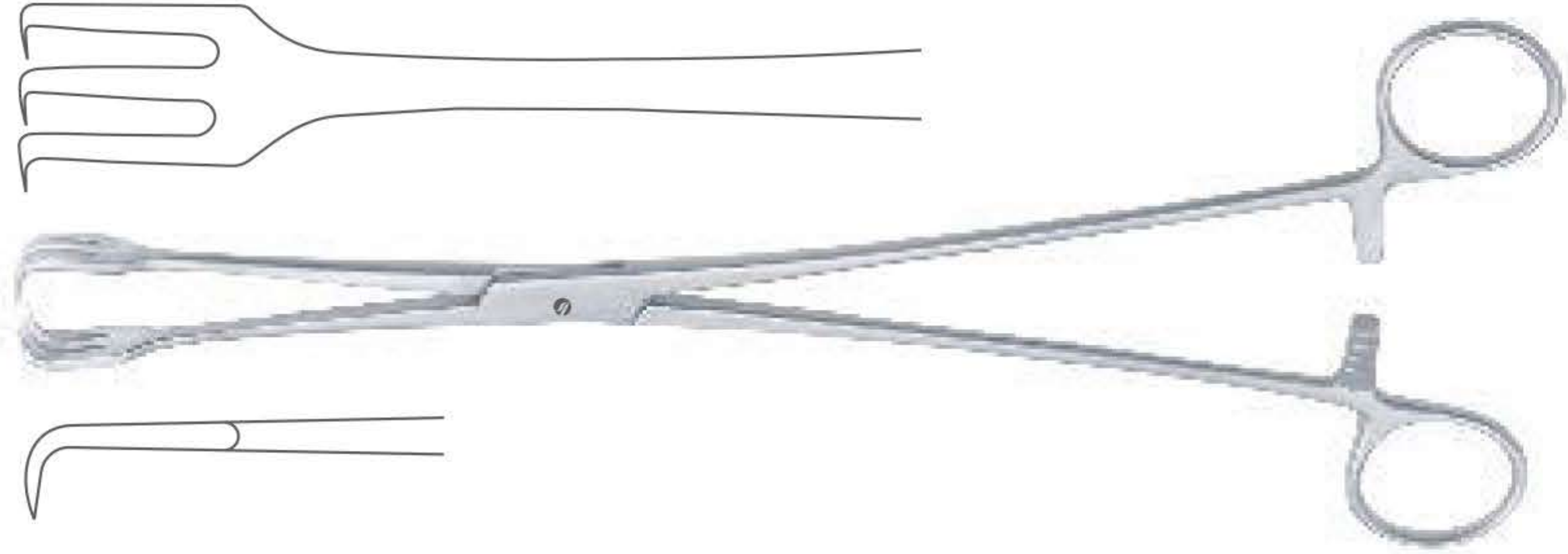

**Teale Tenaculum Forcep**  
 3 x 4 Teeth

Catalog #	Size
GY-591-23	23.5 cm (9 1/4")



**Iowa Tenaculum Forcep**

Catalog #	Size
GY-593-26	26 cm (10 1/4")

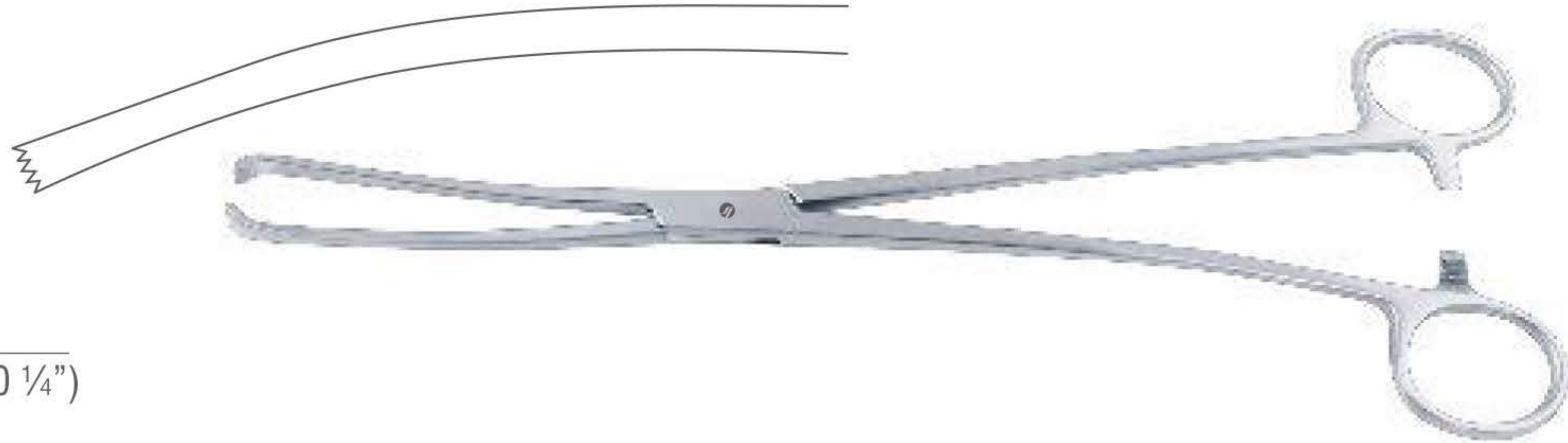

**Museux Tenaculum Forcep**  
 2 x 2 Teeth

Catalog #	Size, Jaw Size
GY-600-07	24 cm (9 1/2"), 7 mm
GY-600-08	24 cm (9 1/2"), 8 mm
GY-600-10	24 cm (9 1/2"), 10 mm



**Jacobs Tenaculum Forcep**  
 2 x 2 Teeth

Catalog #	Size
GY-606-21	21 cm (8 1/4")

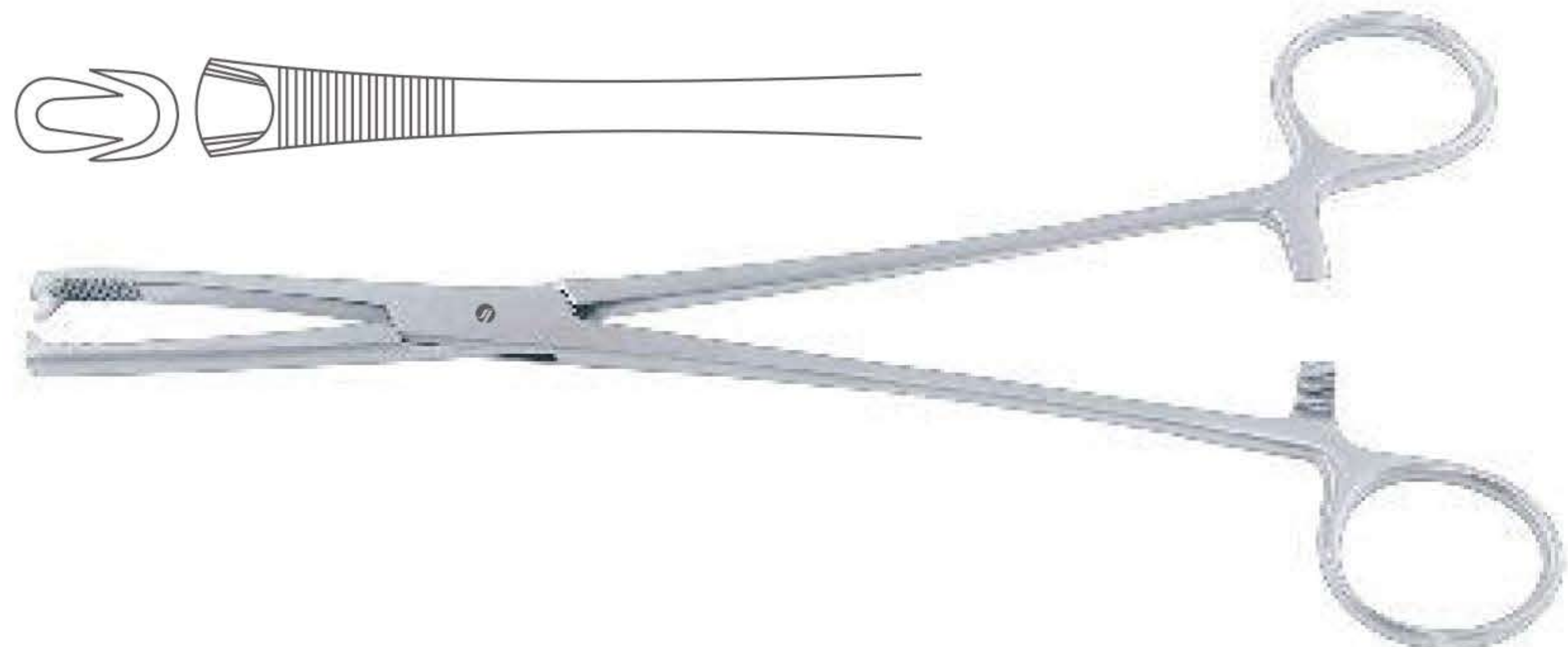
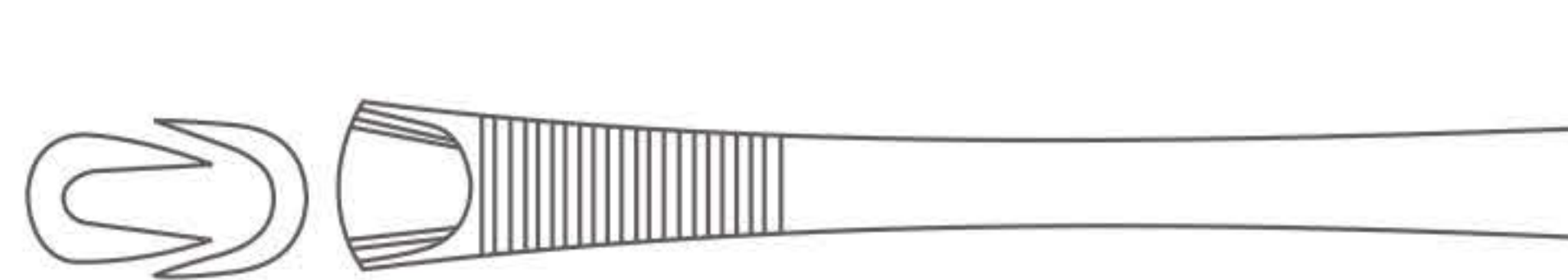

Uterine Tenaculum Forceps, Uterine Polypus Forceps  
 Hakenzangen, Uterus-Polypenzangen  
 Pinza para cuello uterino, Pinzas para pólipos uterinos  
 Pince pour le col de l'utérus, Pincés à polypes utérins  
 Pinza per il collo dell'utero, Pinze per polipi uterini

**Pratt Tenaculum Forcep**

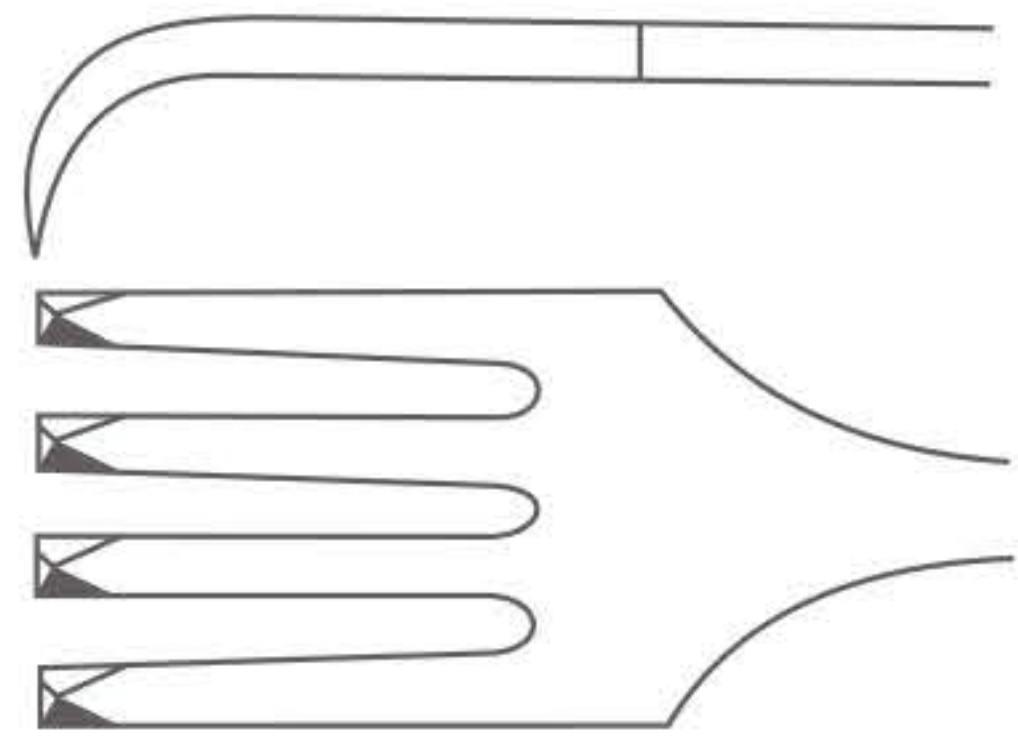

Catalog #	Size
GY-610-26	26.5 cm (10 1/2")

**Museux Tenaculum Forcep**

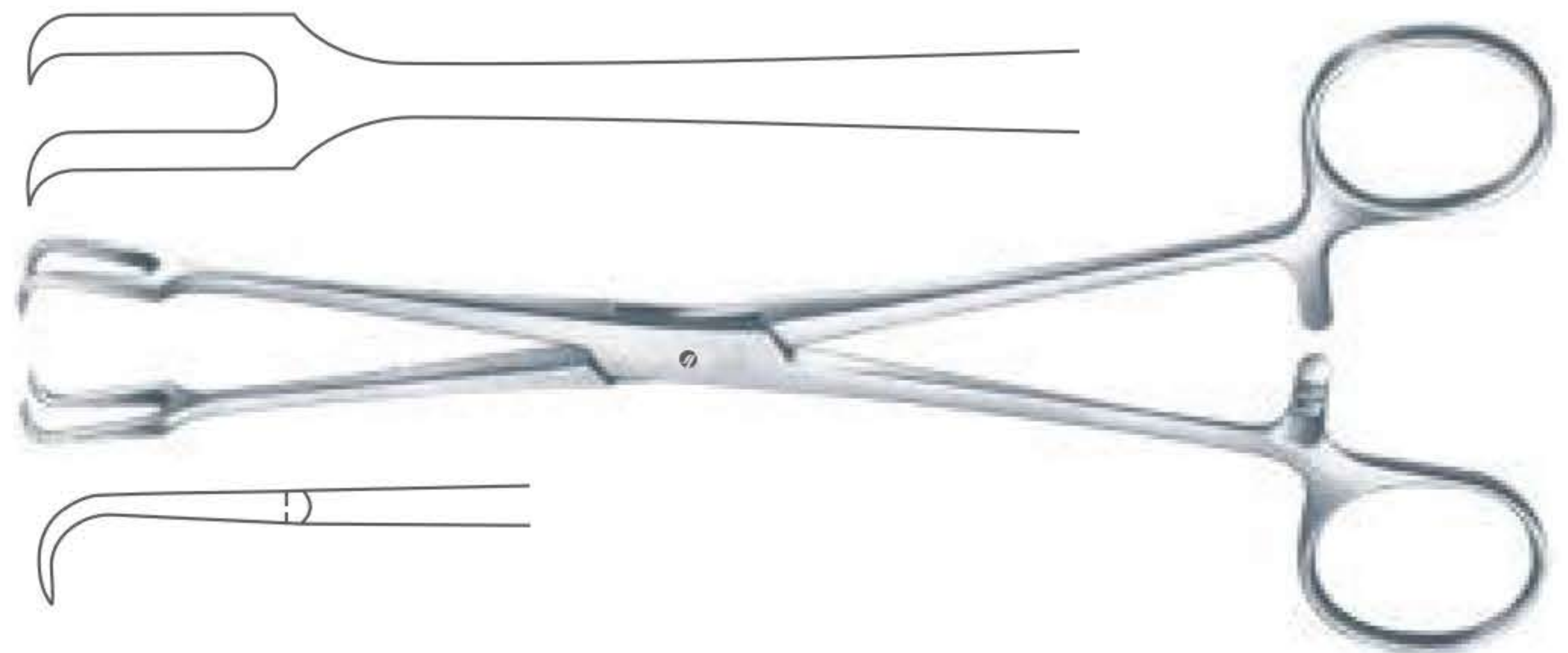
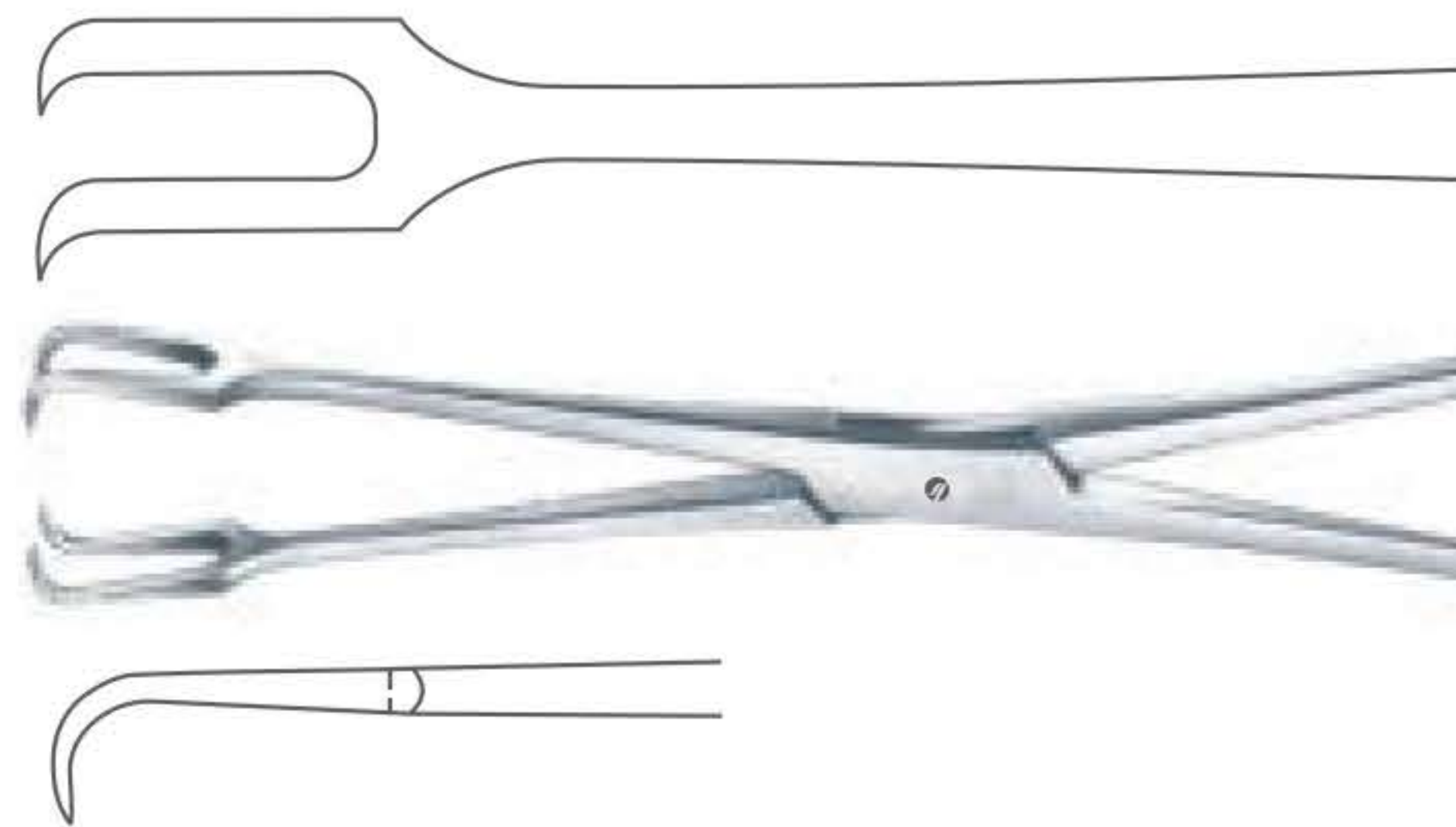

Catalog #	Size
GY-614-20	20 cm (8")

**Braun Tenaculum Forcep**

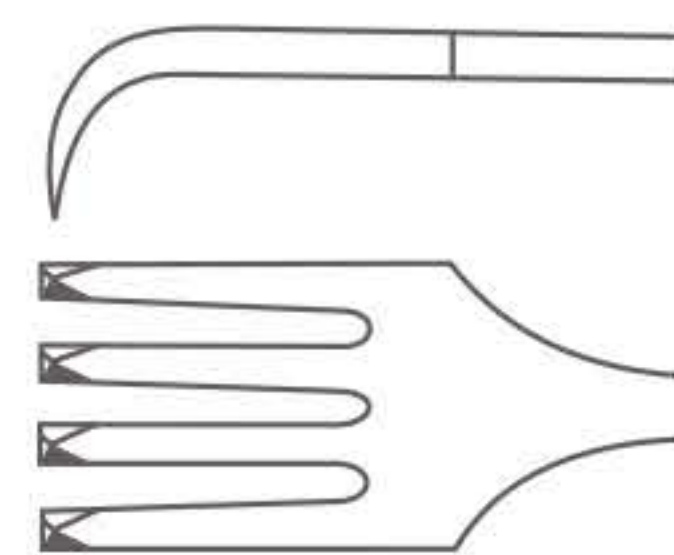

Catalog #	Size
GY-616-16	16 cm (6 1/4")

**Czerny Tenaculum Forcep**

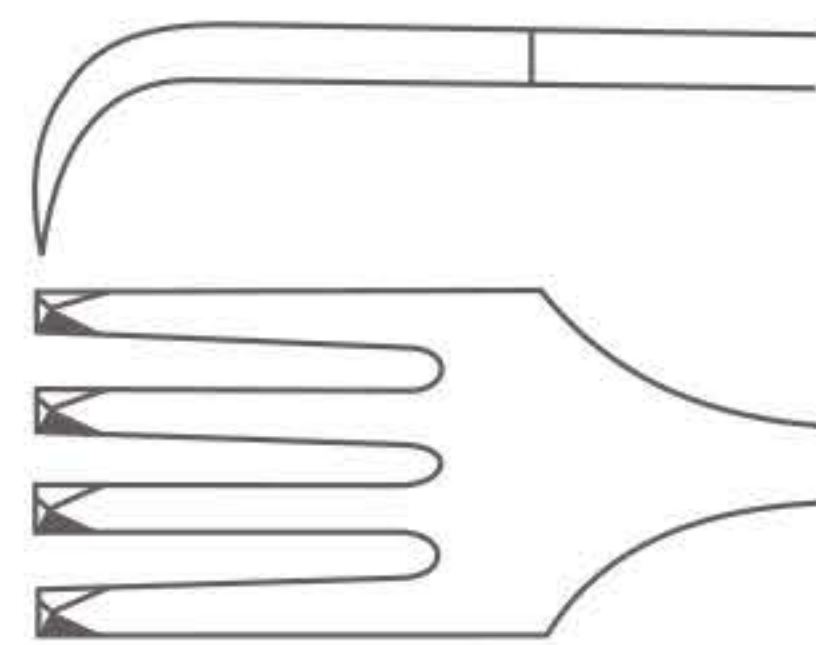

Catalog #	Size
GY-618-21	21 cm (8 1/4")

Uterine Polypus Forceps, Myoma Screws  
 Uterus-Polypenzangen, Myomheber  
 Pinzas para pólipos uterinos, Tirabuzones para fibroma  
 Pincers à polypes utérins, Tracteurs pour fibromes  
 Pinze per polipi uterini, Tiramioni

**Kelly Uterine Polypus Forcep**  
 Without Ratchet

Catalog #	Size
GY-630-32	32 cm (12 1/2")

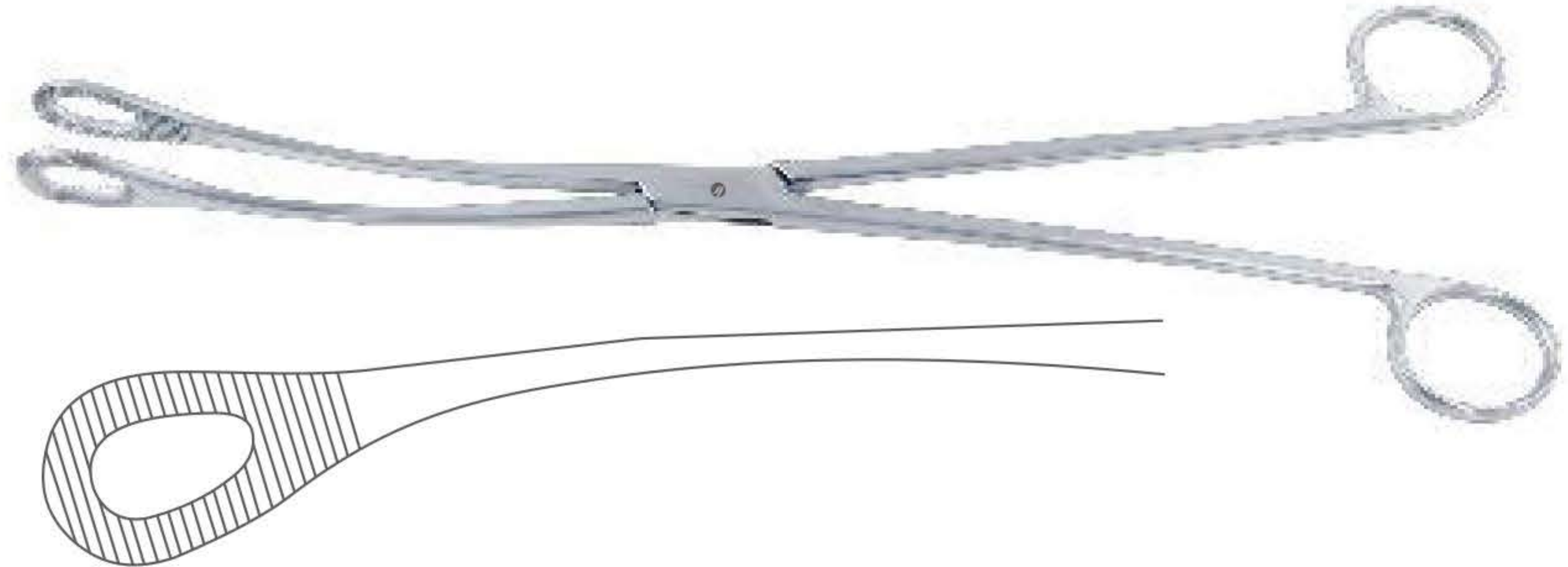

**Kelly Uterine Polypus Forcep**  
 With Ratchet

Catalog #	Size
GY-632-32	32 cm (12 1/2")

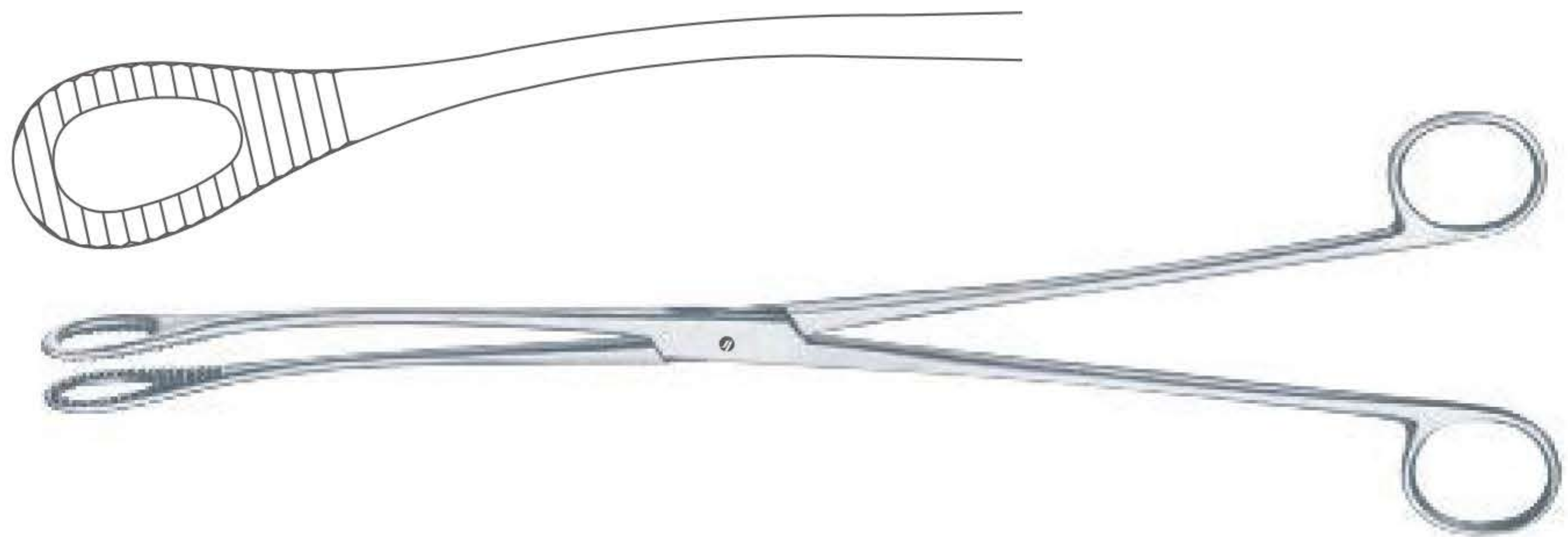

**Noto Uterine Polypus Forcep**

Catalog #	Size
GY-636-27	27 cm (10 3/4")

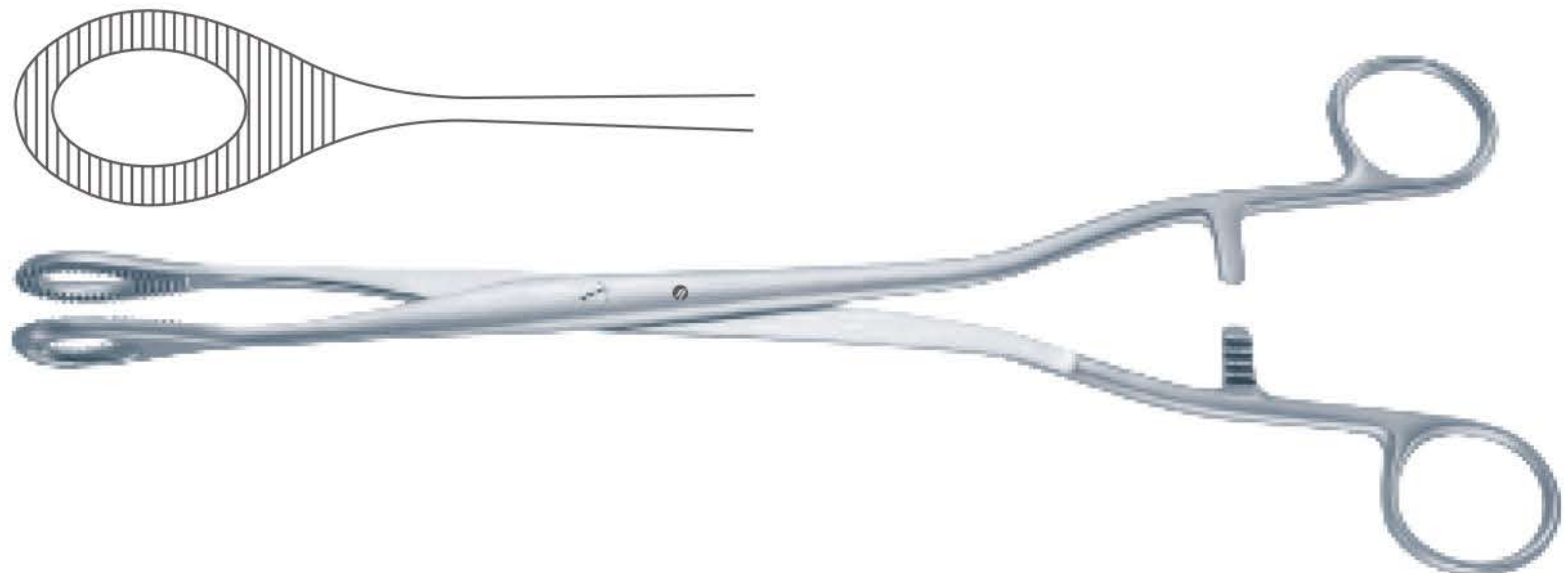

**Heywood-Smith Uterine Polypus Forcep**

Catalog #	Size
GY-640-20	20 cm (8")
GY-640-25	25 cm (9 3/4")

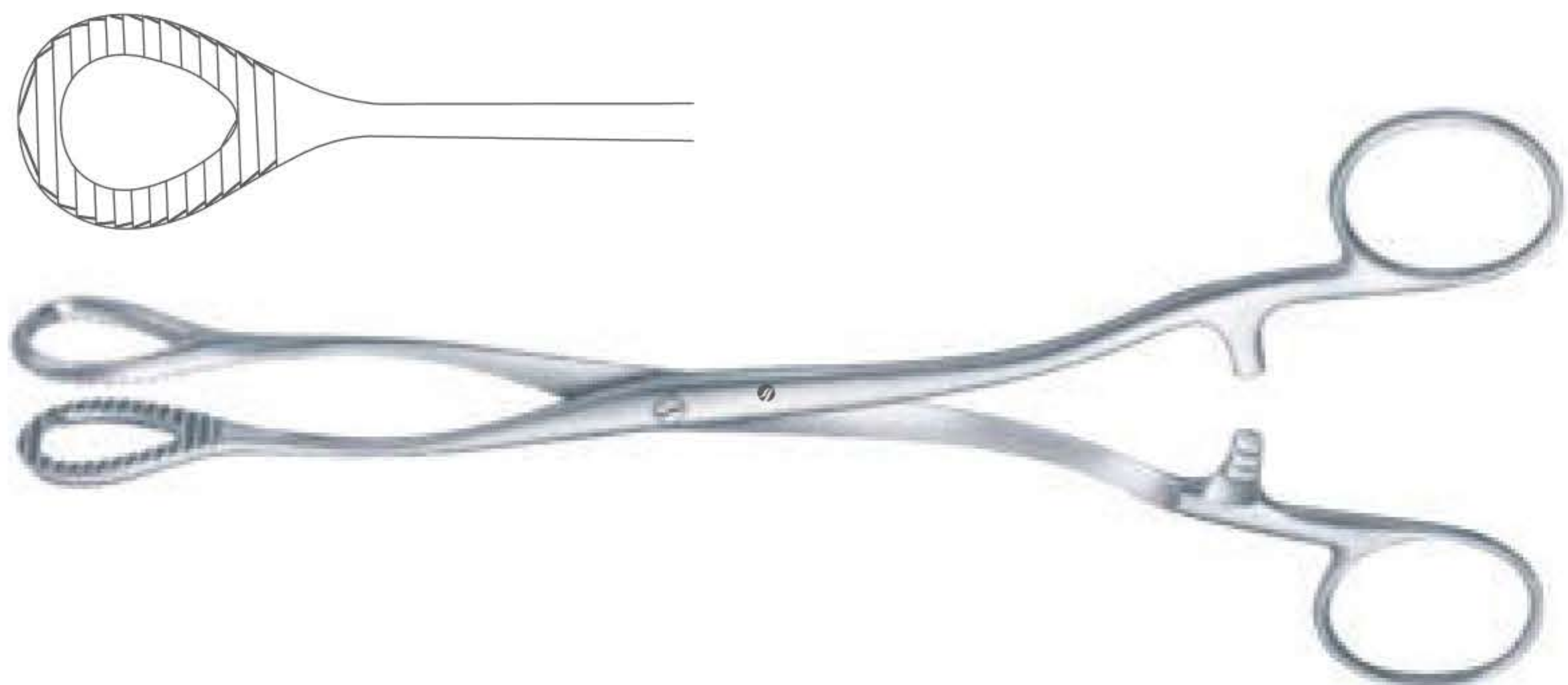

**Doyen Myoma Screw**

Catalog #	Size
GY-651-17	17 cm (6 3/4")



Uterine Seizing Forceps  
 Uterusfasszange  
 Histerólabos  
 Pincés hystérolabes  
 Pinze isterolabi

**Doyen Myoma Screw**



Catalog #	Size
GY-653-14	14.5 cm (5 3/4")

**Segond Myoma Knife**

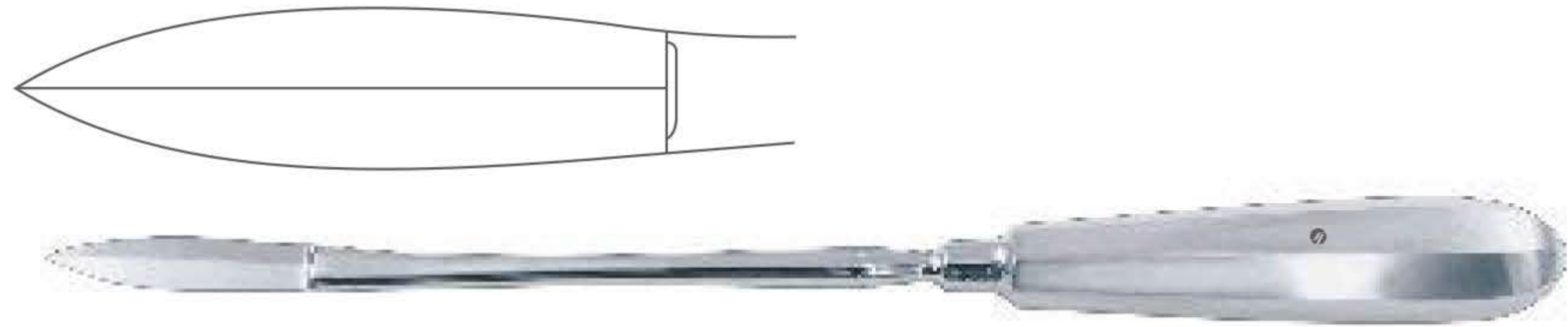

Catalog #	Size Cutting Edge
GY-655-27	28 cm (11"), 13 mm

**Dartigues Uterine Seizing Forcep**

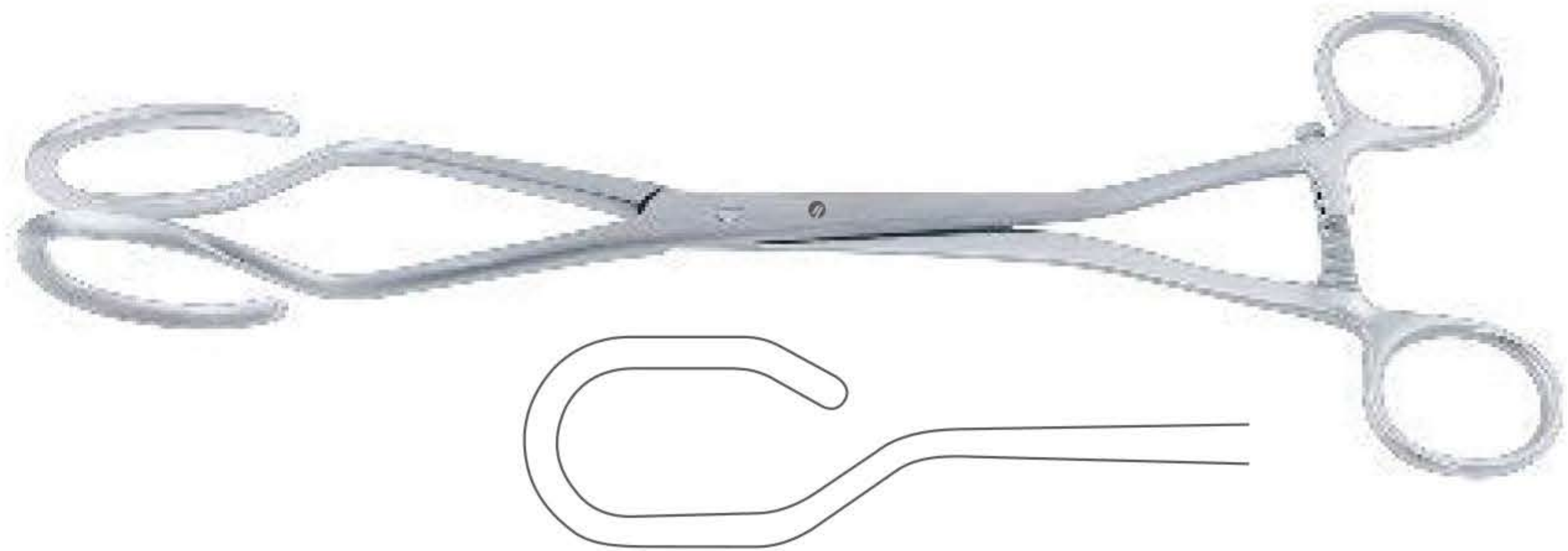

Catalog #	Size, Jaw Size
GY-661-27	28 cm (11"), 32 mm

**Somer Uterine Seizing Forcep**



Catalog #	Size, Jaw Size
GY-663-23	22.5 cm (8 3/4"), 32 mm

**Collin Uterine Seizing Forcep**



Catalog #	Size, Jaw Size
GY-665-26	26 cm (10 1/4"), 40 mm

Fistula Hooks, Suction Currettes  
 Fistelhaken, Saugküretten, Biopsieküretten  
 Ganchos para fistulas, Curetas aspiradoras  
 Crochets pour fistules, Curettes à aspiration  
 Uncini per fistole, Curette d'aspirazione

**Ayre Conization Knife**

Catalog #	Size, Working End
GY-671-23	23.5 cm (9 1/4"), 6.3 mm

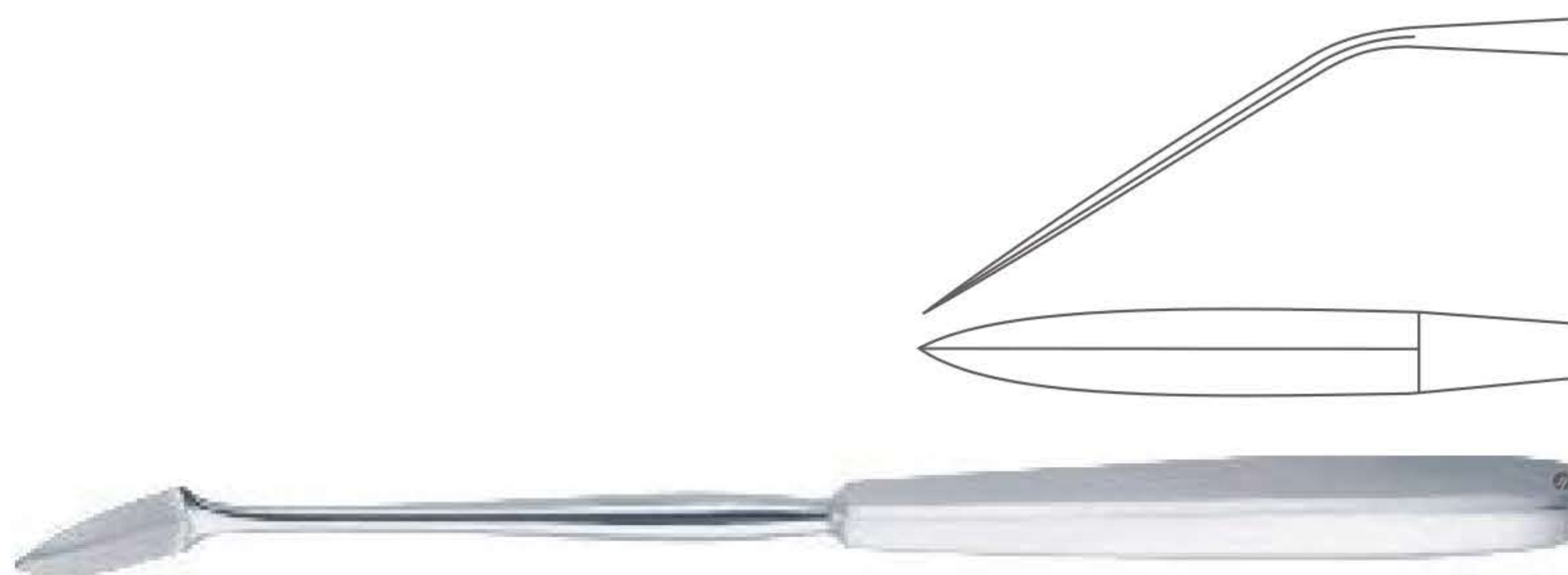

**Emmett Fistula Hook**  
 Fig. 3

Catalog #	Size
GY-681-03	22 cm (8 3/4")



**Simon Fistula Hook**

Catalog #	Size
GY-683-22	21.5 cm (8 1/2")



**Simon Fistula Hook**

Catalog #	Size
GY-685-22	21.5 cm (8 1/2")



**Rheinstaedter Uterine Flushing Curette**  
 Sharp

Catalog #	Cup Size
GY-687-08	8.0 mm
GY-687-11	11.0 mm
GY-687-14	14.0 mm

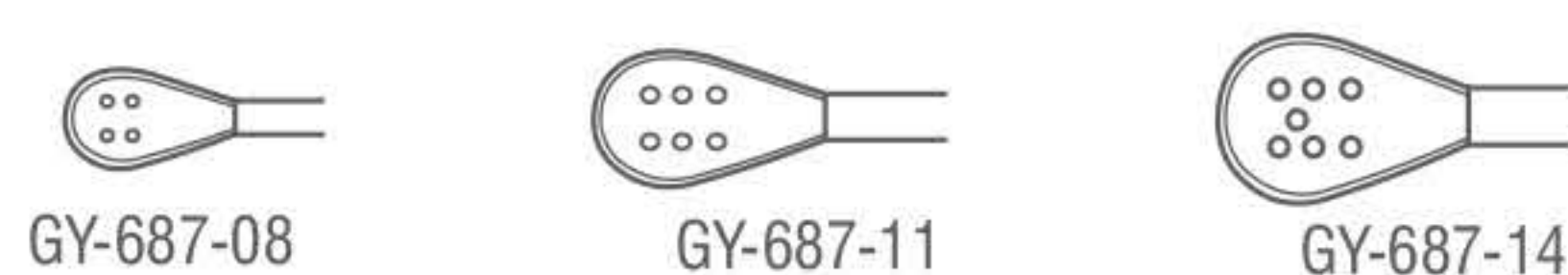

Suction Curettes, Uterine Scoops, Uterine Curettes  
 Saugküretten, Biopsieküretten, Uteruslöffel, Uterusküretten  
 Curetas aspiradoras, Cucharillas uterinas, Curetas uterinas  
 Curettes à aspiration, Curettes utérines, Curettes utérines  
 Curette d'aspirazione, Curette uterine, Curette uterine

**Novak Suction Curette**  
 With Luer-Lock Connection



Catalog #	Size, Diameter
GY-691-23	24.5cm (9 3/4"), Ø 4.0 mm

**Kevorkian Biopsy Curette**

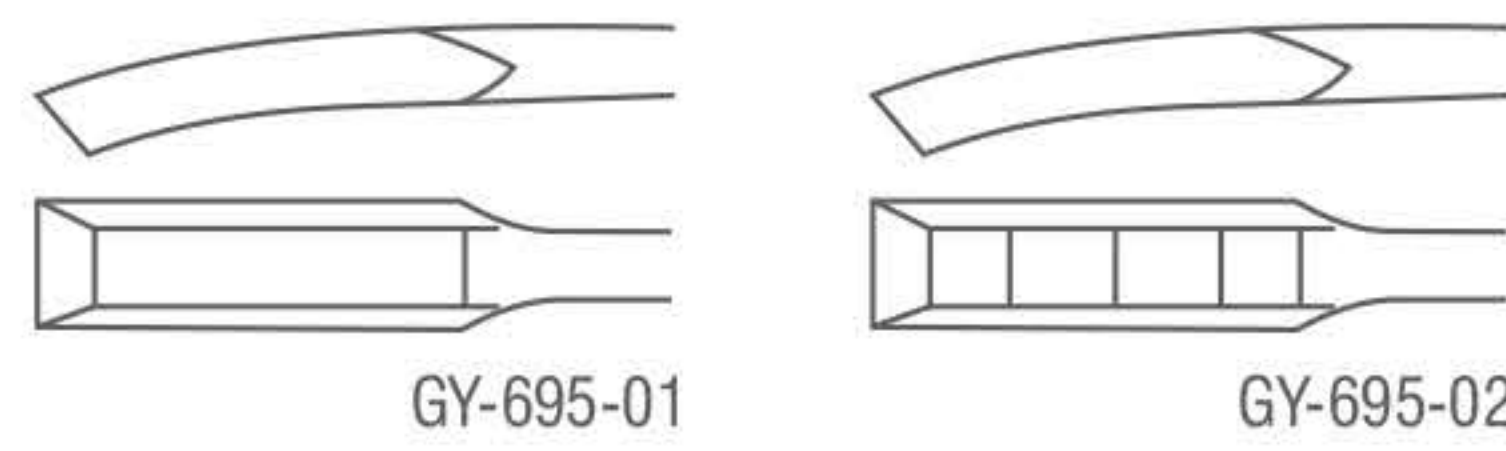

Catalog #	Size, Diameter, Profile
GY-695-01	30 cm (11 3/4"), Ø 6.0 mm, Without Basket
GY-695-02	30 cm (11 3/4"), Ø 6.0 mm, With Basket

**Randall Biopsy Curette**



Catalog #	Size, Diameter
GY-697-24	24 cm (9 1/2"), Ø 4.0 mm

**Munchen Biopsy Curette**

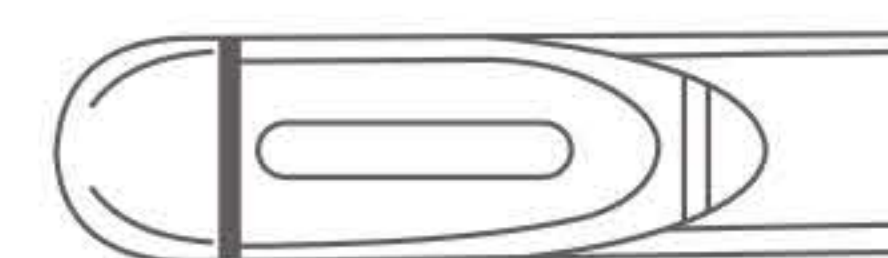
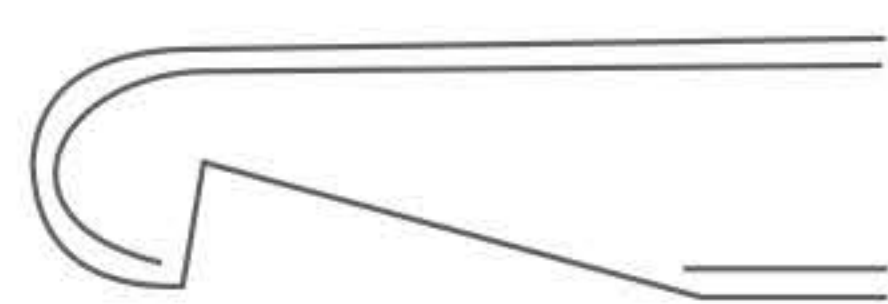

Catalog #	Size, Diameter
GY-699-27	27 cm (10 3/4"), Ø 4.8 mm

**Simon Uterine Curette**  
 Sharp - Rigid

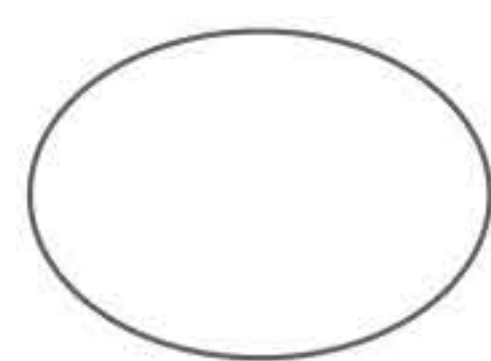

Catalog #	Size, Cup Size
GY-700-01	24.5 cm (9 3/4"), 9.8 x 6.8 mm
GY-700-02	24.5 cm (9 3/4"), 11.6 x 8.3mm
GY-700-03	24.5 cm (9 3/4"), 13.2 x 10.0 mm
GY-700-04	24.5 cm (9 3/4"), 16.0 x 11.6mm
GY-700-05	25 cm (9 3/4"), 18.0 x 12.6 mm
GY-700-06	25 cm (9 3/4"), 20.0 x 13.8 mm

Uterine Curettes  
 Uterusküretten  
 Curetas uterinas  
 Curettes utérines  
 Curette uterine

**Simon Uterine Curette**  
 Sharp - Rigid

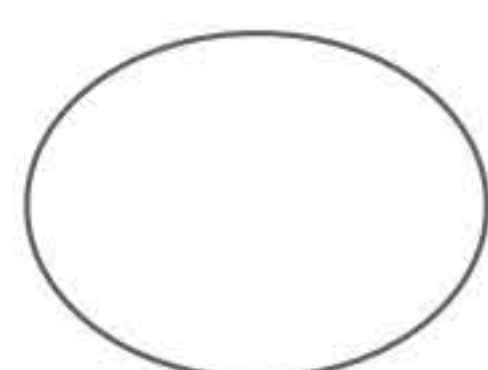

Catalog #	Size, Cup Size
GY-702-01	30 cm (11 3/4), 9.8 x 6.8 mm
GY-702-02	30 cm (11 3/4), 11.6 x 8.3mm
GY-702-03	31 cm (12 1/4), 13.2 x 10.0 mm
GY-702-04	31 cm (12 1/4), 16.0 x 11.6mm
GY-702-05	31 cm (12 1/4), 18.0 x 12.6 mm
GY-702-06	31 cm (12 1/4), 20.0 x 13.8 mm

**Blake Uterine Curette**  
 Sharp/Blunt



Catalog #	Size
GY-707-28	28 cm (11")

**Recamier Uterine Curette**  
 Sharp - Rigid

Catalog #	Size, Width , Profile
GY-710-05	31 cm (12 1/4"), 5 mm, Fig. 00
GY-710-06	31 cm (12 1/4"), 6 mm, Fig. 0
GY-710-07	31 cm (12 1/4"), 7 mm, Fig. 1
GY-710-08	31 cm (12 1/4"), 8 mm, Fig. 2
GY-710-09	31 cm (12 1/4"), 9 mm, Fig. 3
GY-710-11	31 cm (12 1/4"), 11 mm, Fig. 4
GY-710-12	31 cm (12 1/4"), 12 mm, Fig. 5
GY-710-14	31 cm (12 1/4"), 14 mm, Fig. 6
GY-710-15	31 cm (12 1/4"), 15 mm, Fig. 7
GY-710-16	31 cm (12 1/4"), 16 mm, Fig. 8
GY-710-19	31 cm (12 1/4"), 19 mm, Fig. 9
GY-710-20	31 cm (12 1/4"), 21 mm, Fig. 10
GY-710-21	31 cm (12 1/4"), 20 mm, Fig. 11
GY-710-23	31 cm (12 1/4"), 23 mm, Fig. 12
GY-710-25	34 cm (13 1/2"), 25 mm, Fig. 13
GY-710-30	35 cm (13 3/4"), 30 mm, Fig. 14
GY-710-35	35 cm (13 3/4"), 35 mm, Fig. 15
GY-710-40	35 cm (13 3/4"), 40 mm, Fig. 16



Uterine Currettes  
 Uterusküretten  
 Curetas uterinas  
 Curettes utérines  
 Curette uterine

**Recamier Uterine Curette**  
 Sharp - Malleable

Catalog #	Size, Width, Profile
GY-711-05	31 cm (12 ¼"), 5 mm, Fig. 00
GY-711-06	31 cm (12 ¼"), 6 mm, Fig. 0
GY-711-07	31 cm (12 ¼"), 7 mm, Fig. 1
GY-711-08	31 cm (12 ¼"), 8 mm, Fig. 2
GY-711-09	31 cm (12 ¼"), 9 mm, Fig. 3
GY-711-11	31 cm (12 ¼"), 11 mm, Fig. 4
GY-711-12	31 cm (12 ¼"), 12 mm, Fig. 5
GY-711-14	31 cm (12 ¼"), 14 mm, Fig. 6
GY-711-15	31 cm (12 ¼"), 15 mm, Fig. 7
GY-711-16	31 cm (12 ¼"), 16 mm, Fig. 8
GY-711-19	31 cm (12 ¼"), 19 mm, Fig. 9
GY-711-20	31 cm (12 ¼"), 20mm, Fig. 10
GY-711-21	31 cm (12 ¼"), 21 mm, Fig. 11
GY-711-23	31 cm (12 ¼"), 23 mm, Fig. 12
GY-711-25	34 cm (13 ½"), 25 mm, Fig. 13
GY-711-30	35 cm (13 ¾"), 30 mm, Fig. 14
GY-711-35	35 cm (13 ¾"), 35 mm, Fig. 15
GY-711-40	35 cm (13 ¾"), 40 mm, Fig. 16



Uterine Curettes  
 Uterusküretten  
 Curetas uterinas  
 Curettes utérines  
 Curette uterine

**Sims Uterine Curette**  
 Blunt - Rigid

Catalog #	Size, Width
GY-712-05?	31 cm (12 ¼"), 5 mm, Fig. 00
GY-712-06	31 cm (12 ¼"), 6 mm, Fig. 0
GY-712-07	31 cm (12 ¼"), 7 mm, Fig. 1
GY-712-08	31 cm (12 ¼"), 8 mm, Fig. 2
GY-712-09	31 cm (12 ¼"), 9 mm, Fig. 3
GY-712-11	31 cm (12 ¼"), 11 mm, Fig. 4
GY-712-12	31 cm (12 ¼"), 12 mm, Fig. 5
GY-712-14	31 cm (12 ¼"), 14 mm, Fig. 6
GY-712-15	31 cm (12 ¼"), 15 mm, Fig. 7
GY-712-16	31 cm (12 ¼"), 16 mm, Fig. 8
GY-712-19	31 cm (12 ¼"), 19 mm, Fig. 9
GY-712-20	31 cm (12 ¼"), 20 mm, Fig. 10
GY-712-21	31 cm (12 ¼"), 21 mm, Fig. 11
GY-712-23	31 cm (12 ¼"), 23 mm, Fig. 12
GY-712-25	34 cm (13 ½"), 25 mm, Fig. 13
GY-712-30	35 cm (13 ¾"), 30 mm, Fig. 14
GY-712-35	35 cm (13 ¾"), 35 mm, Fig. 15
GY-712-40	35 cm (13 ¾"), 40 mm, Fig. 16



Uterine Curettes  
 Uterusküretten  
 Curetas uterinas  
 Curettes utérines  
 Curette uterine

**Sims Uterine Curette**  
 Blunt - Malleable

Catalog #	Size, Width
GY-713-05	31 cm (12 ¼"), 5 mm, Fig. 00
GY-713-06	31 cm (12 ¼"), 6 mm, Fig. 0
GY-713-07	31 cm (12 ¼"), 7 mm, Fig. 1
GY-713-08	31 cm (12 ¼"), 8 mm, Fig. 2
GY-713-09	31 cm (12 ¼"), 9 mm, Fig. 3
GY-713-11	31 cm (12 ¼"), 11 mm, Fig. 4
GY-713-12	31 cm (12 ¼"), 12 mm, Fig. 5
GY-713-14	31 cm (12 ¼"), 14 mm, Fig. 6
GY-713-15	31 cm (12 ¼"), 15 mm, Fig. 7
GY-713-16	31 cm (12 ¼"), 16 mm, Fig. 8
GY-713-19	31 cm (12 ¼"), 19 mm, Fig. 9
GY-713-20	31 cm (12 ¼"), 20 mm, Fig. 10
GY-713-21	31 cm (12 ¼"), 21 mm, Fig. 11
GY-713-23	31 cm (12 ¼"), 23 mm, Fig. 12
GY-713-25	31 cm (12 ¼"), 25 mm, Fig. 13
GY-713-30	31 cm (12 ¼"), 30 mm, Fig. 14
GY-713-35	31 cm (12 ¼"), 35 mm, Fig. 15
GY-713-40	31 cm (12 ¼"), 40 mm, Fig. 16



**Greene Uterine Curette**

Catalog #	Size, Width
GY-721-10	28 cm (11"), 10 mm
GY-721-12	28 cm (11"), 12 mm
GY-721-14	28 cm (11"), 14 mm

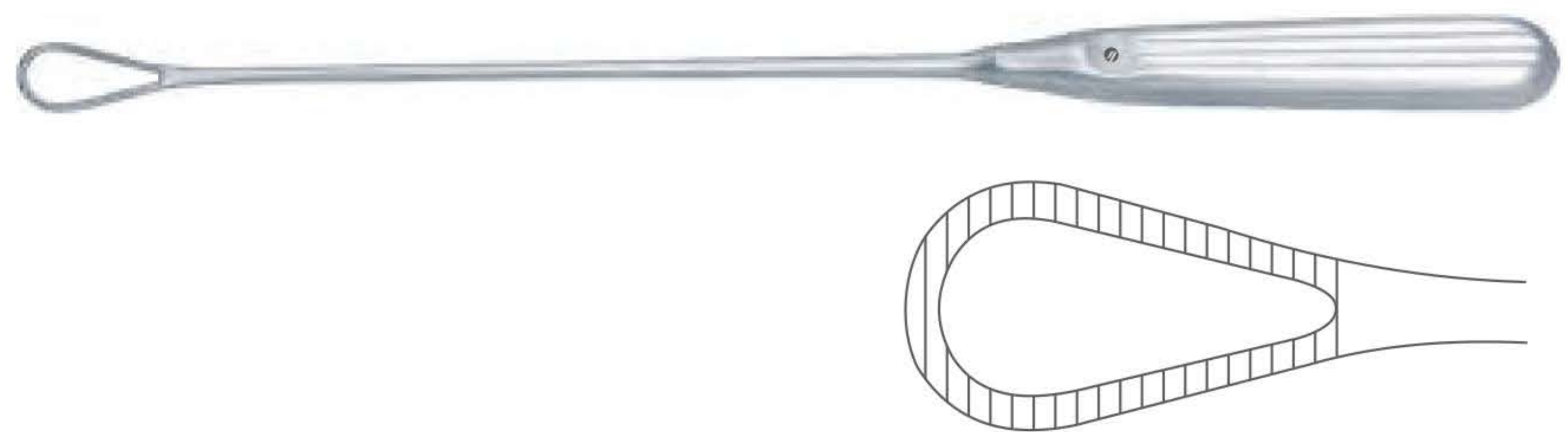

Suction Curettes, Uterine Biopsy Forceps  
 Absaugküretten, Probeexzisionszangen  
 Curetas aspiradoras, Pinzas para biopsia  
 Curettes d'aspiration, Pincas pour biopsie  
 Curette per aspirazione, Pinze per biopsia

**Aspirating Biopsy Curette**

Catalog #	Size, Diameter
GY-731-03	29 cm (11 1/2"), Ø 3.0 mm
GY-731-04	29 cm (11 1/2"), Ø 4.5 mm
GY-731-06	29 cm (11 1/2"), Ø 6.0 mm
GY-731-08	29 cm (11 1/2"), Ø 8.0 mm
GY-731-10	29 cm (11 1/2"), Ø 9.0 mm
GY-731-12	29 cm (11 1/2"), Ø 12.0 mm
GY-731-14	29 cm (11 1/2"), Ø 14.0 mm



**Coupling Piece**

Catalog #	Size
GY-735-12	12 cm (4 3/4")

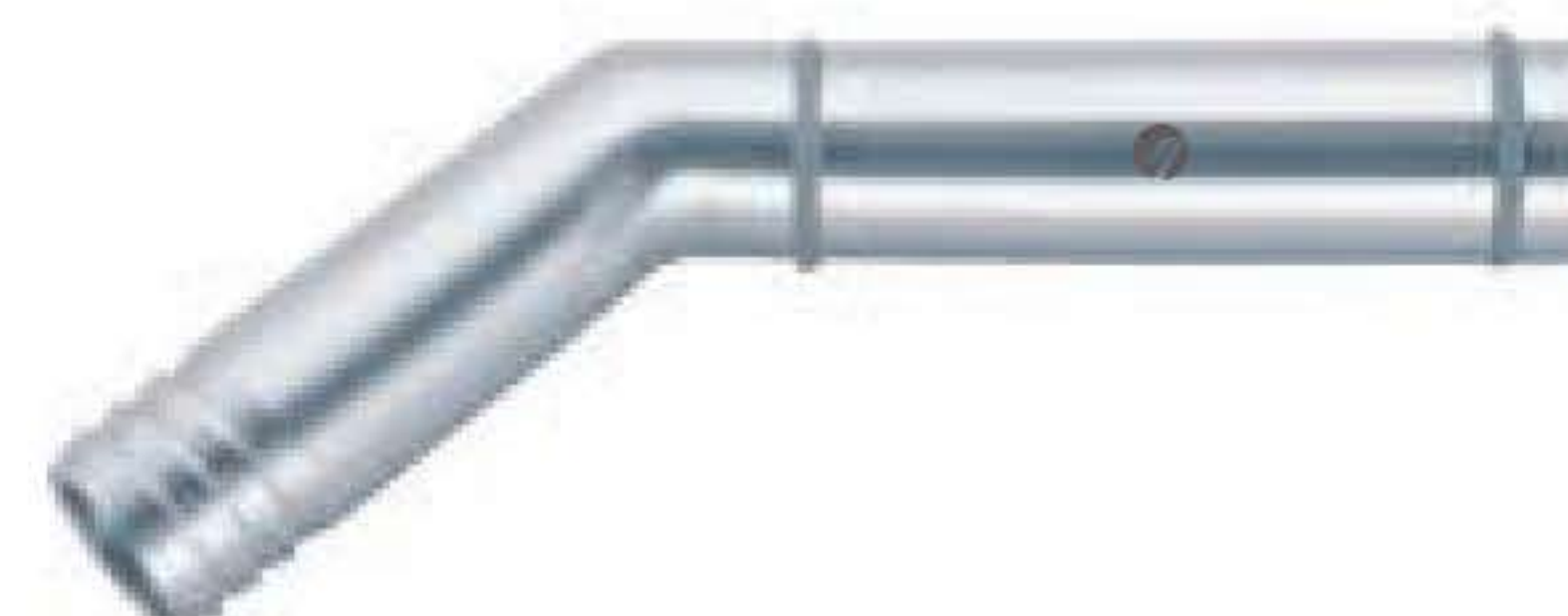

**Gellhorn Biopsy Forcep**

Catalog #	Size, Bite Size
GY-801-23	24 cm (9 1/2"), 8.6 mm



**Faure Biopsy Forcep**

Catalog #	Size, Bite Size
GY-805-21	21 cm (8 1/4"), 8.4 mm



Uterine Biopsy Forceps  
 Probeexzisionszangen  
 Pinzas para biopsia  
 Pinces pour biopsie  
 Pinze per biopsia

**Schubert Biopsy Forcep**



Catalog #	Size, Bite Size
GY-808-21	21.5 cm (8 1/2"), 4.8 mm
GY-808-28	28 cm (11"), 4.8 mm

**Thomas-Gaylor Biopsy Forcep**



Catalog #	Size, Bite Size
GY-812-21	21 cm (8 1/4"), 5.6 mm Ø
GY-812-24	24 cm (9 1/2"), 5.6 mm Ø

**Schubert Biopsy Forcep**

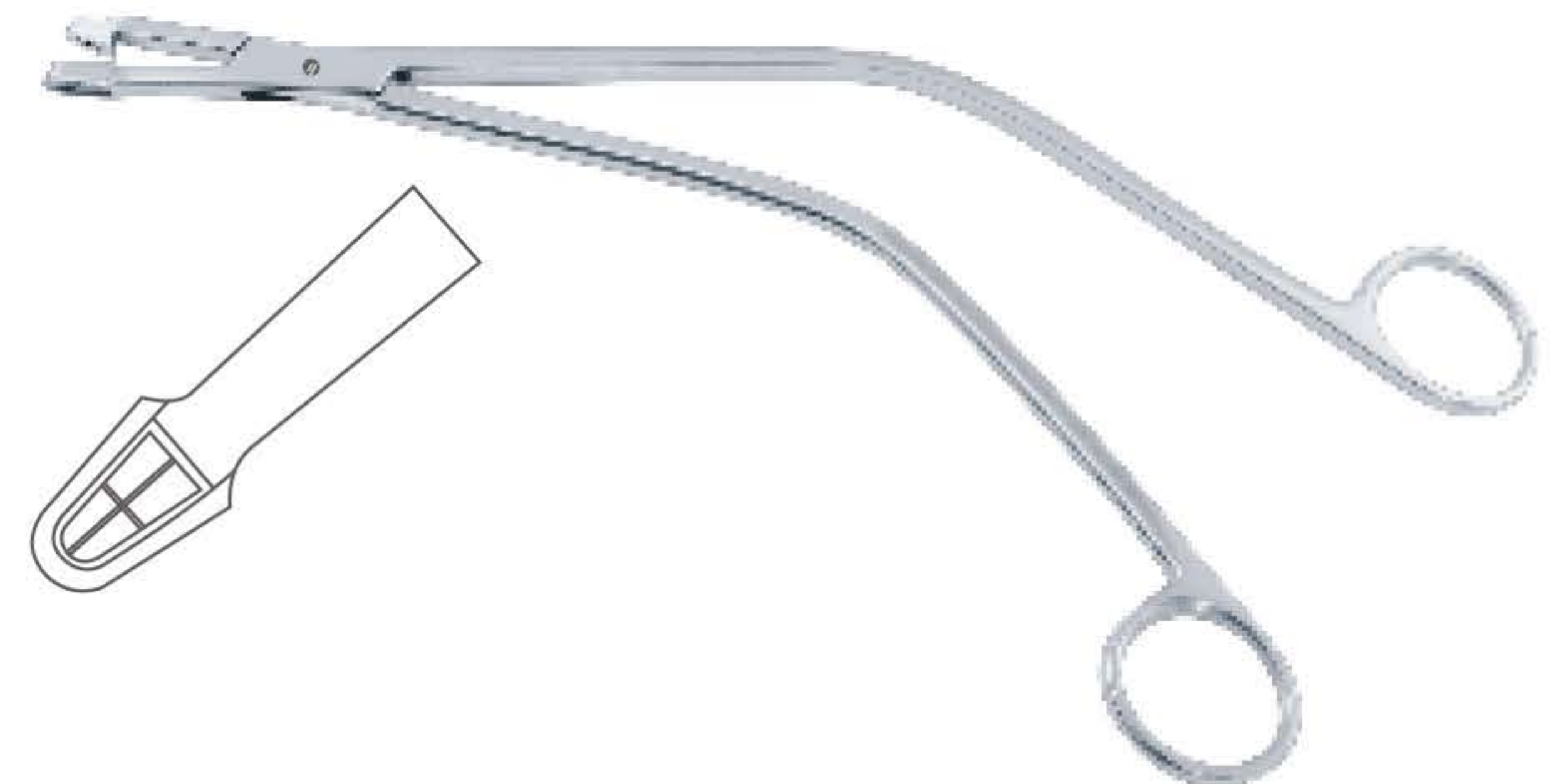

Catalog #	Size, Bite Size
GY-818-24	24 cm (9 1/2"), 5.0 mm

**Van Doren Biopsy Forcep**



Catalog #	Size, Bite Size
GY-821-27	27 cm (10 3/4"), 5.5 mm

**Van Doren Biopsy Forcep**

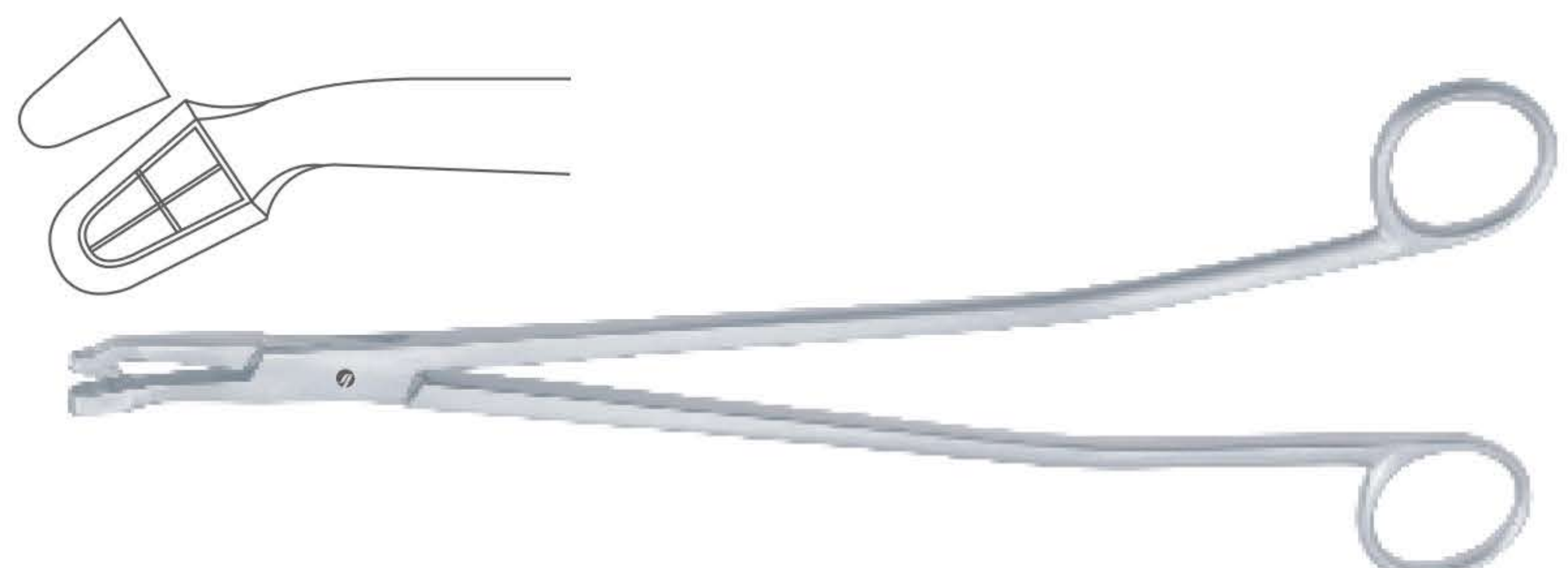

Catalog #	Size, Bite Size
GY-823-25	25.5 cm (10"), 4.9 mm

Uterine Biopsy Forceps  
 Probeexzisionszangen  
 Pinzas para biopsia  
 Pincas pour biopsie  
 Pinze per biopsia

**Alexander Biopsy Forcep**

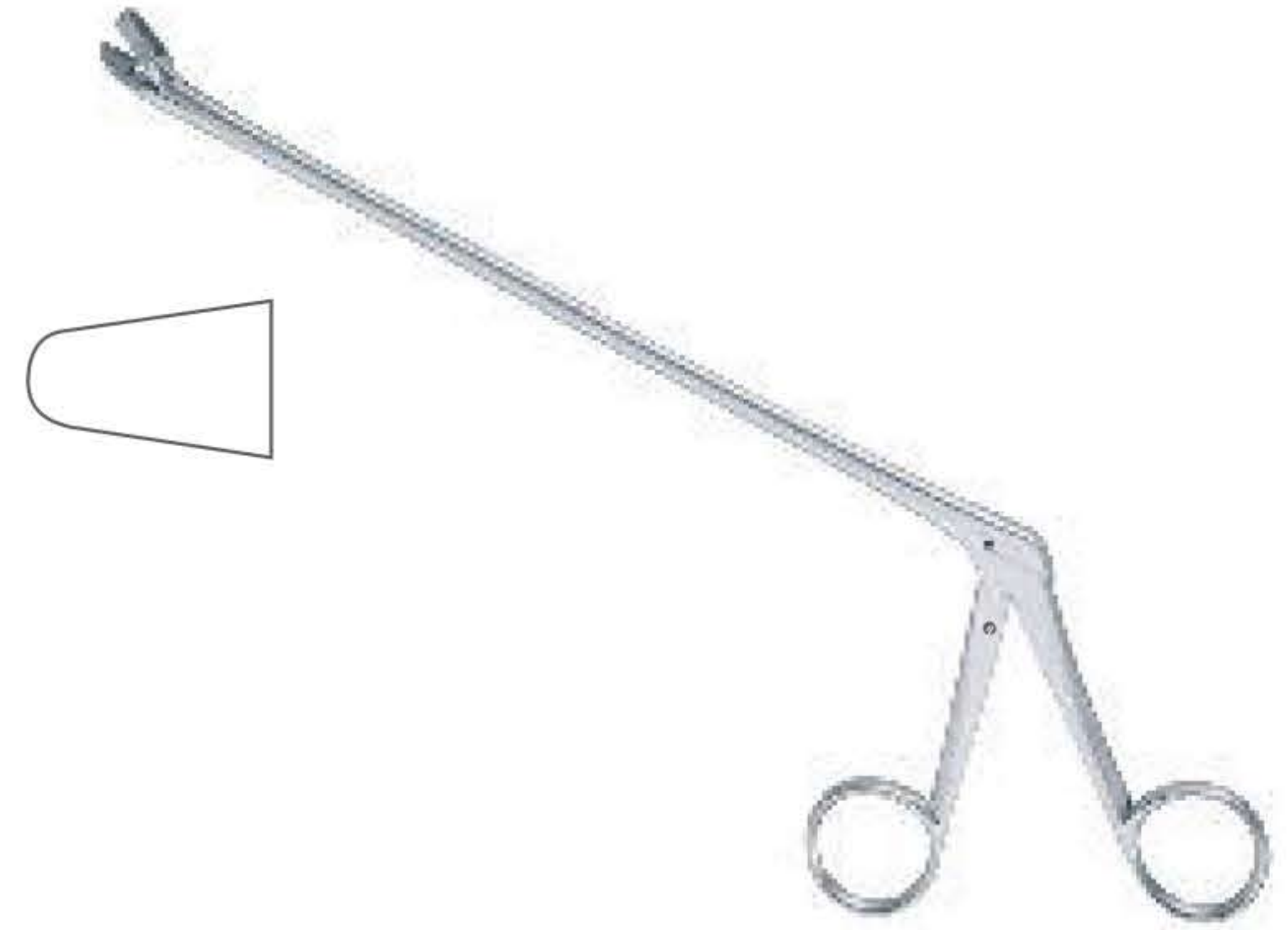

Catalog #	Size, Bite Size
GY-841-28	19.5 cm (7 3/4"), 5.1 mm

**Kevorkian Biopsy Forcep**



Catalog #	Size, Jaw Width
GY-845-23	23 cm (9"), 3 mm

**Schumacher Biopsy Forcep**



Catalog #	Size, Bite Size
GY-849-01	24 cm (9 1/2"), 4.6 mm
GY-849-02	24 cm (9 1/2"), 5.4 mm

**Kevorkian-Pacific Biopsy Forcep**



Catalog #	Size, Bite Size
GY-865-22	22 cm (8 3/4"), 3 x 10 mm

**Tischler-Baby Biopsy Forcep**



Catalog #	Size, Bite Size
GY-869-20	20 cm (8"), 2.3 x 4.2 mm

Uterine Biopsy Forceps  
 Probeexzisionszangen  
 Pinzas para biopsia  
 Pincas pour biopsie  
 Pinze per biopsia

**Tischler-Morgan Biopsy Forcep**

Catalog #	Size, Bite Size
GY-871-22	22 cm (8 3/4"), 3 x 7 mm



**Tischler Biopsy Forcep Complete**  
 Detachable Handle

Catalog #	Size
GY-881-25	25.5 cm (10")



**Kevorkian Biopsy Forcep Complete**  
 Detachable Handle

Catalog #	Size
GY-883-25	25.5 cm (10")



**Eppendorf Biopsy Forcep Complete**  
 Detachable Handle

Catalog #	Size
GY-885-25	25.5 cm (10")



**Mini-Townsend Biopsy Forcep Complete**  
 Detachable Handle

Catalog #	Size
GY-887-25	25 cm (10")



Uterine Biopsy Forceps  
 Probeexzisionszangen  
 Pinzas para biopsia  
 Pincas pour biopsie  
 Pinze per biopsia

**Biopsy Handle Only**

Catalog #	Size
GY-895-00	Standard



**Tischler Biopsy Forcep Tip Only**

Catalog #	Size
GY-895-01	25.5 cm (10")



**Kevorkian Biopsy Forcep Tip Only**

Catalog #	Size
GY-895-02	25.5 cm (10")



**Eppendorf Biopsy Forcep Tip Only**

Catalog #	Size
GY-895-03	25.5 cm (10")



**Mini-Townsend Biopsy Forcep Tip Only**

Catalog #	Size
GY-895-04	25.5 cm (10")



IUD Instruments  
 IUP Instrumente  
 Instrumentos de DIU  
 Instruments de DIU  
 Strumenti di IUD

**IUD Grasping Forcep**

Flexible Shaft for Grasping Intra Uterine Pessary



Catalog #	Size, Jaw Size
GY-901-22	22.5 cm (8 3/4"), 3.0 mm Ø
GY-901-27	27 cm (10 3/4"), 3.0 mm Ø

**IUD Removal Hook**



Catalog #	Size
GY-905-31	31 cm (12 1/4")

**Cohen Uterine Cannula**

With 2 Cones Ref:- GY-951-01 and GY-951-02



Catalog #	Size
GY-951-00	Standard

**Cohen Cone Only**



Catalog #	Tip Length
GY-951-01	19 mm
GY-951-02	25 mm

**Leech Wilkinson Intra Uterine Cannula**

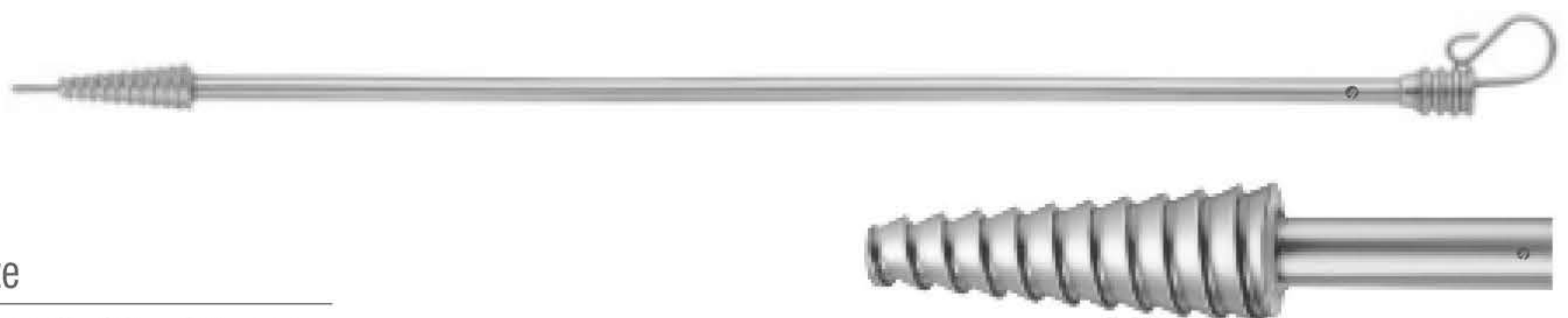

Catalog #	Size, Profile, Tip Size
GY-961-01	26.5 cm (10 1/2"), Small, 10 x 25 mm
GY-961-02	26.5 cm (10 1/2"), Medium, 13 x 30 mm
GY-961-03	26.5 cm (10 1/2"), Large, 16 x 30 mm



# NJ ENTERPRISES



Obstetrics  
Instruments

Pelvimeter, Obstetrical Forceps  
 Beckenzirkel, Geburtszangen,  
 Pelvímeter, Forceps obstétricos  
 Pelvimètre, Forceps obstétriques  
 Pelvimetri, Forcipi obstetrici

**DeLee Pelvimeter**  
 For Internal Measurements

Catalog #	Size
OB-101-20	20 cm (8")



**Martin Pelvimeter**  
 Cm and inch Scale

Catalog #	Size
OB-105-34	34 cm (13 1/2")



**Naegele Obstetrical Forcep**

Catalog #	Size
OB-151-36	35 cm (13 3/4")
OB-151-40	40.5 cm (16")



**Simpson Obstetrical Forcep**

Catalog #	Size
OB-155-30	31 cm (12 1/4")



**Wrigley Obstetrical Forcep**

Catalog #	Size
OB-159-28	28 cm (11")



Obstetrical Forceps  
 Geburtszangen,  
 Forceps obstétricos  
 Forceps obstétriques  
 Forcipi obstetrici

**Simpson-Braun Obstetrical Forcep**

Catalog #	Size
OB-161-36	36.5 cm (14 1/4")



**Kielland Obstetrical Forcep**

Catalog #	Size
OB-165-41	41 cm (16 1/4")



**Kielland-Luikart Obstetrical Forcep**

Catalog #	Size
OB-171-40	40 cm (15 3/4")



**Piper Obstetrical Forcep**

Catalog #	Size
OB-175-44	44.5 cm (17 3/4")



**Elliot Obstetrical Forcep**

Catalog #	Size
OB-177-38	38 cm (15")



Obstetrical Forceps  
 Geburtszangen,  
 Forceps obstétricos  
 Forceps obstétriques  
 Forcipi obstetrici

**Simpson-Luikart Obstetrical Forcep**



Catalog #	Size
OB-179-36	36 cm (14")

**Bill Obstetrical Traction Handle Forcep**



Catalog #	Size
OB-195-00	Standard

**Sellheim Obstetrical Lever**



Catalog #	Size
OB-201-32	32 cm (12 1/2")

**Green-Armytage Uterine Clamp**



Catalog #	Size
OB-300-21	21 cm (8 1/4")

**Saenger Placenta and Ovum Forcep  
 Straight**

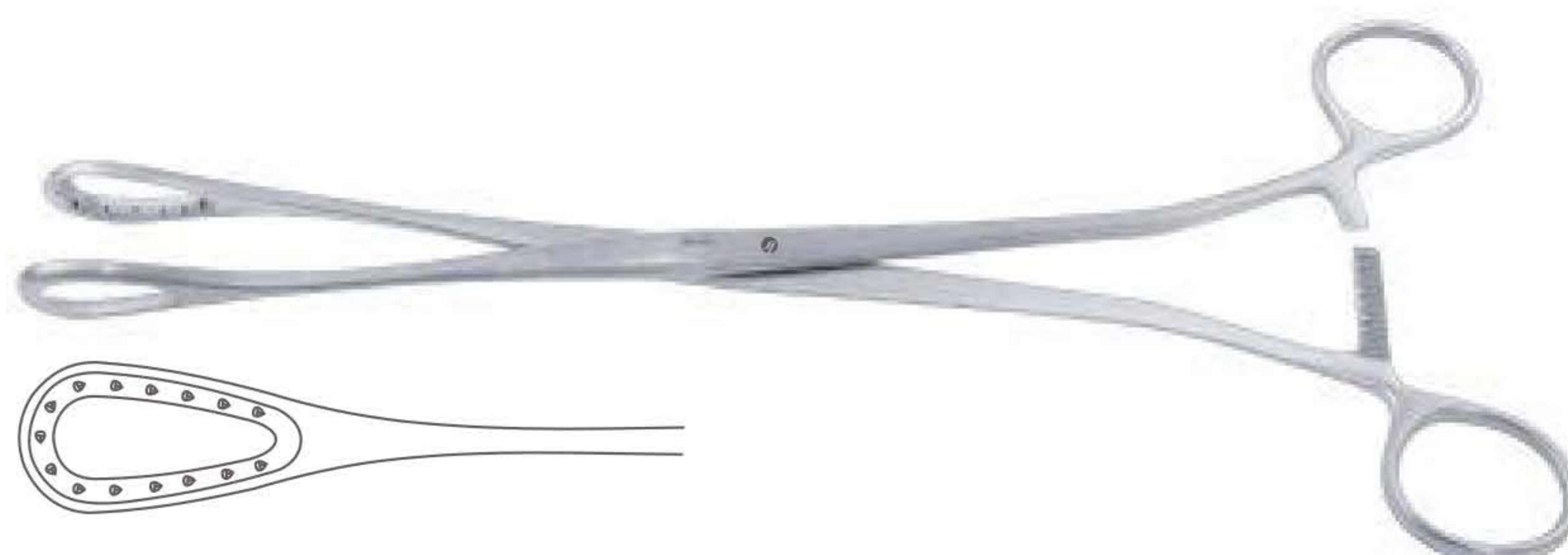

Catalog #	Size
OB-350-27	27.5 cm (10 3/4")

Placenta and Ovum Forceps  
 Abortuszangen  
 Pinzas para aborto  
 Pincas placentaires et pour poste-abortum  
 Pinze per placenta e per ovaie

**Saenger Placenta and Ovum Forcep**  
 Curved

Catalog #	Size
OB-351-27	27 cm (10 3/4")

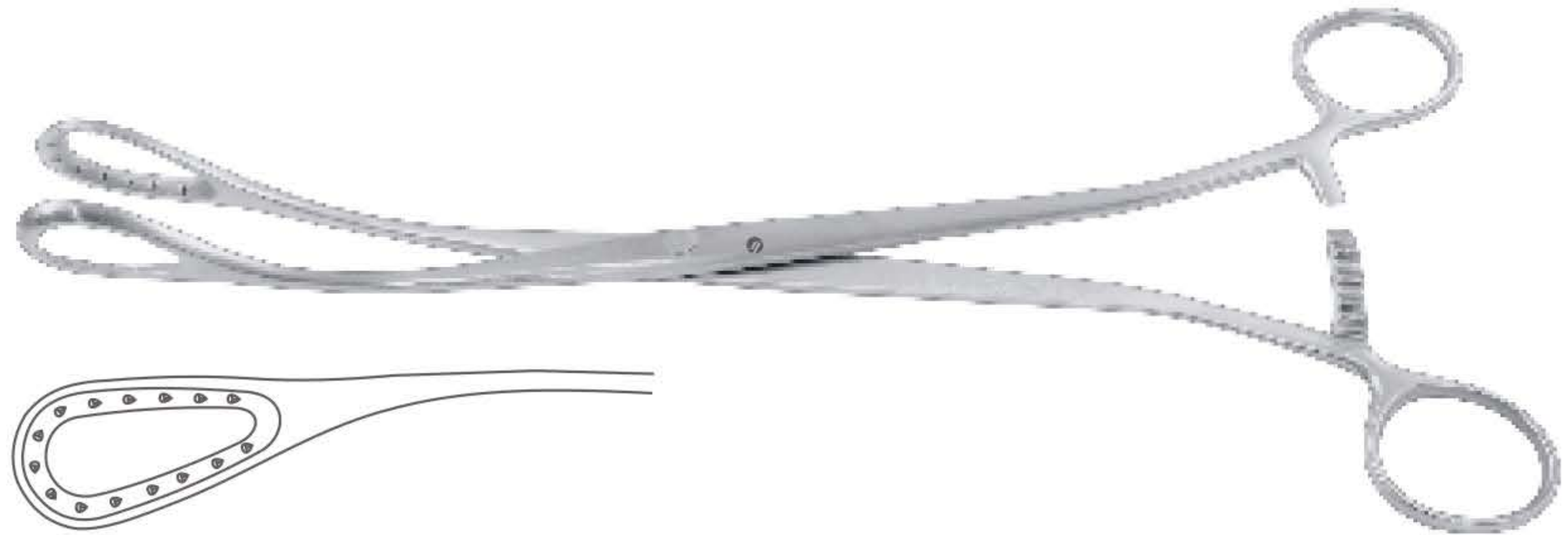

**Winter Placenta and Ovum Forcep**  
 Fig. 1

Catalog #	Size, Profile
OB-360-01	28 cm (11"), Str
OB-360-02	28 cm (11"), Cu

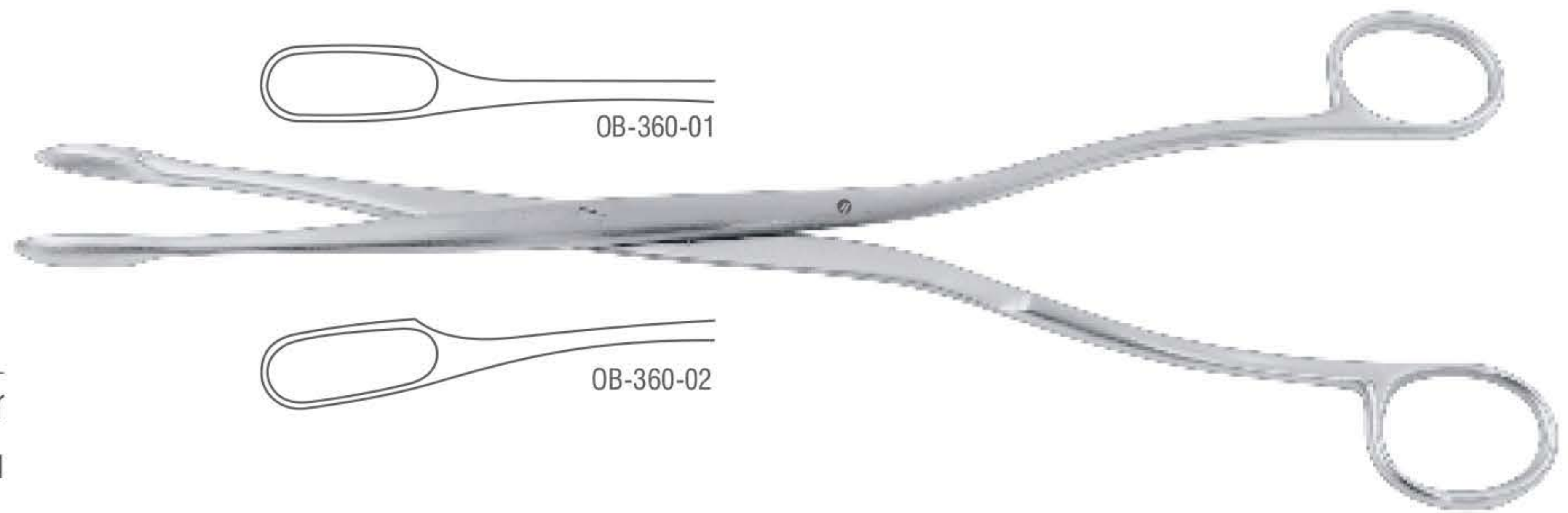

**Winter Placenta and Ovum Forcep**  
 Fig. 2

Catalog #	Size, Profile
OB-361-01	28 cm (11"), Str
OB-361-02	28 cm (11"), Cu

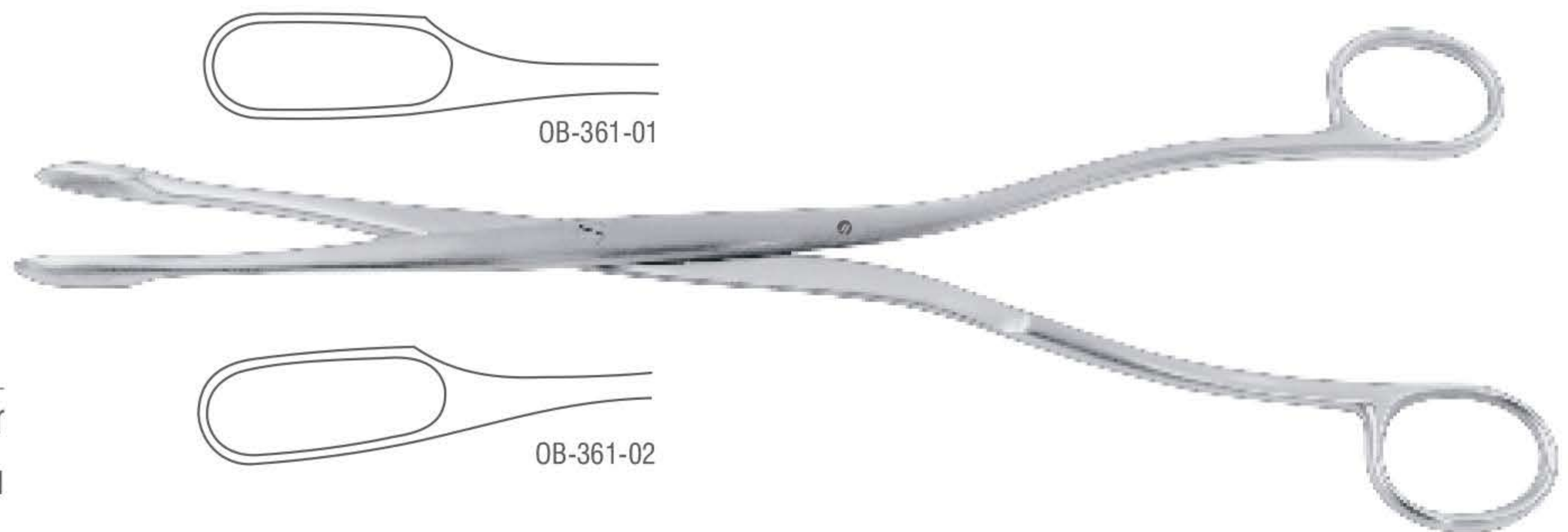

**Cuzzi Placenta Scoop**  
 Blunt, Back Side Serrated

Catalog #	Size, Cup Size
OB-401-17	30 cm (11 3/4"), 17 mm
OB-401-20	30 cm (11 3/4"), 20 mm
OB-401-22	30 cm (11 3/4"), 22 mm

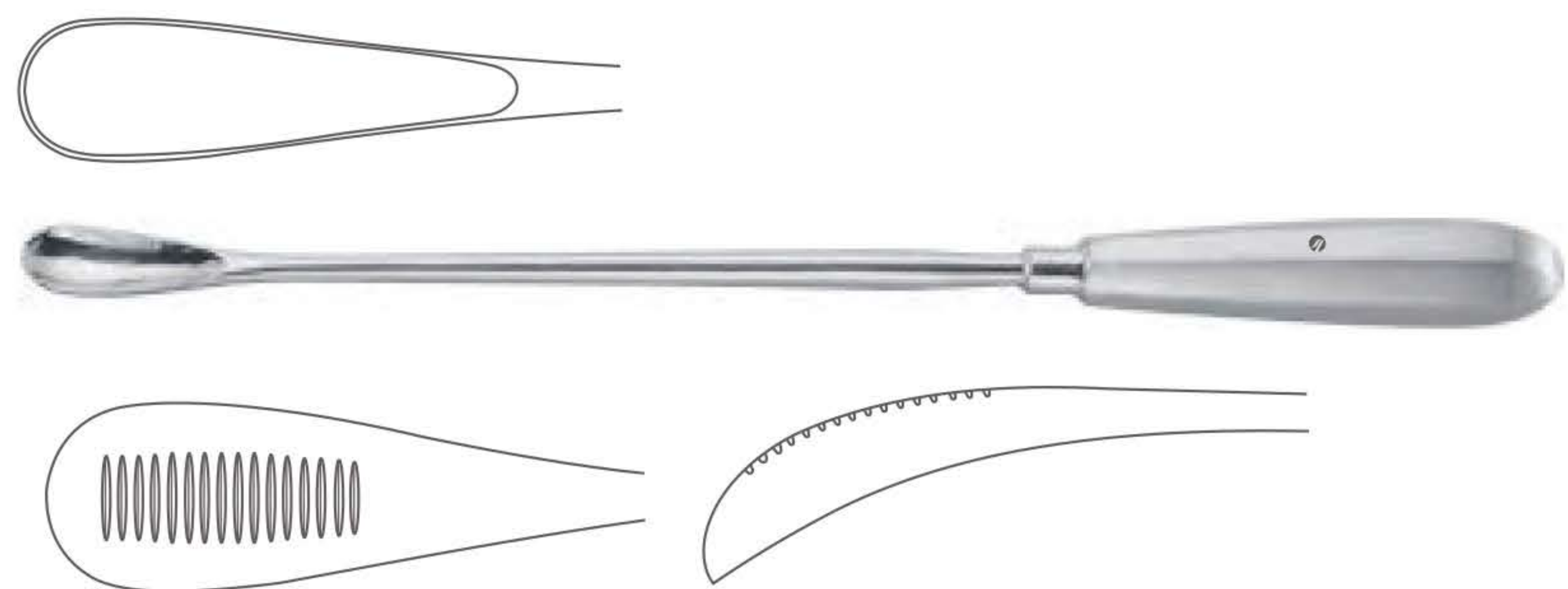

Placenta Scoops, Perforators, Decapitating Hooks  
 Abortuslöffel, Perforatorien, Dekapitationshaken  
 Cucharillas para aborto, Perfora-Cráneos, Ganchos para decapitación  
 Curettes a avortement et placenta, Perce-crânes, Crochets pour détroncation  
 Cucchiari per placenta e ovaie, Spezzacrani, Uncino per detroncazione

**Pestalozza Placenta Scoop**

Catalog #	Size
OB-415-30	30 cm (11 3/4")

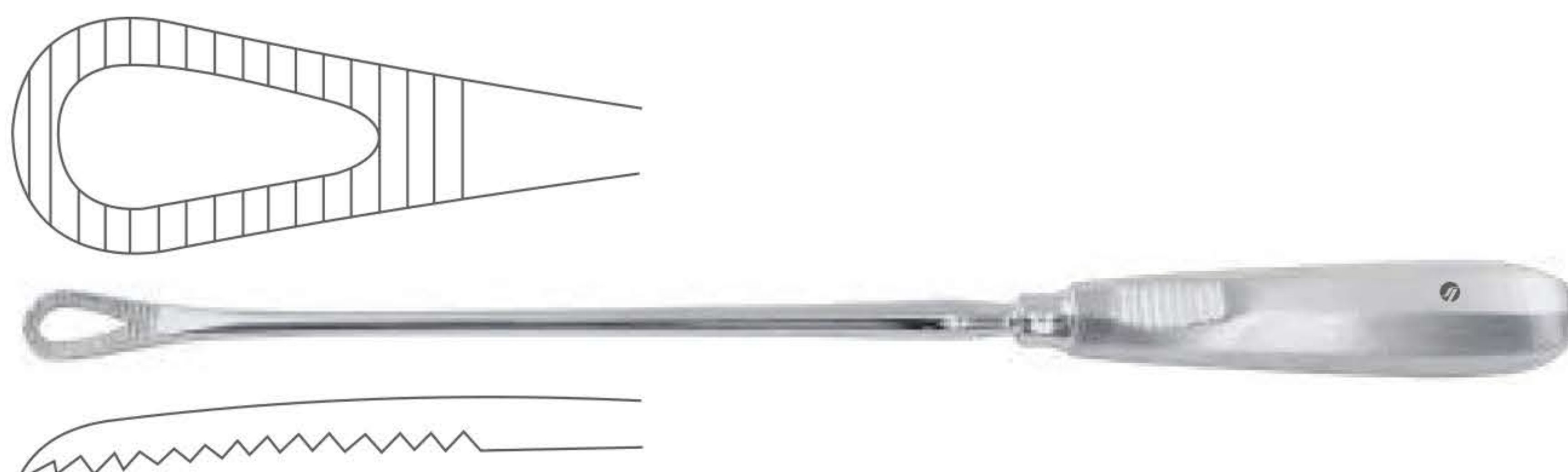

**Wallich Placenta Scoop**

Catalog #	Size
OB-417-42	42 cm (16 1/2")



**Naegele Perforator**

Catalog #	Size
OB-480-25	25.5 cm (10")



**Smellie Perforator**

Catalog #	Size
OB-482-25	25.5 cm (10")



**Braun Decapitating Hook**

Catalog #	Size
OB-501-30	30 cm (11 3/4")



Basiotribe, Cranioclast, Umbilical Cord Clamps  
 Basiotrib, Kranioklast, Nabelschnurklemmen  
 Basiotribo, Craneoclasto, Clamps umbilicales  
 Basiotribe, Cranioclaste, Clamps ombilicaux  
 Basiotribo, Cranioclaste, Clamps ombelicali

**Smellie Decapitating Hook**



Catalog #	Size
OB-505-30	30 cm (11 3/4")

**Tranier Basiotribe**



Catalog #	Size
OB-600-46	46 cm (18")

**Braun Cranioclast**



Catalog #	Size
OB-621-42	42 cm (16 1/2")

**Kane Umbilical Cord Clamp**



Catalog #	Size
OB-661-08	8.5 cm (3 1/4")

**Collin Umbilical Cord Clamp**



Catalog #	Size
OB-663-08	8.5 cm (3 1/4")