

NJ ENTERPRISES

Block # 4, Rashid Minhas Road, Small Industries Estate Sialkot - Pakistan.

Whatsapp: Mob: 0092 333 8733922
Phone: 0092 52 3257502
Fax: 0092 52 3257501

E-mail: akif@nj-ent.co
njenterprisespk@yahoo.com
Website: www.nj-ent.com



Ophthalmic Surgery

Instruments

Eye Speculum
 Lidsperrer
 Blefarostatos
 Blépharostats
 Blefarostati

Barraquer Wire Speculum
 Standard Wire

Catalog #	Blade Size
OP-010-10	10 mm
OP-010-15	15 mm

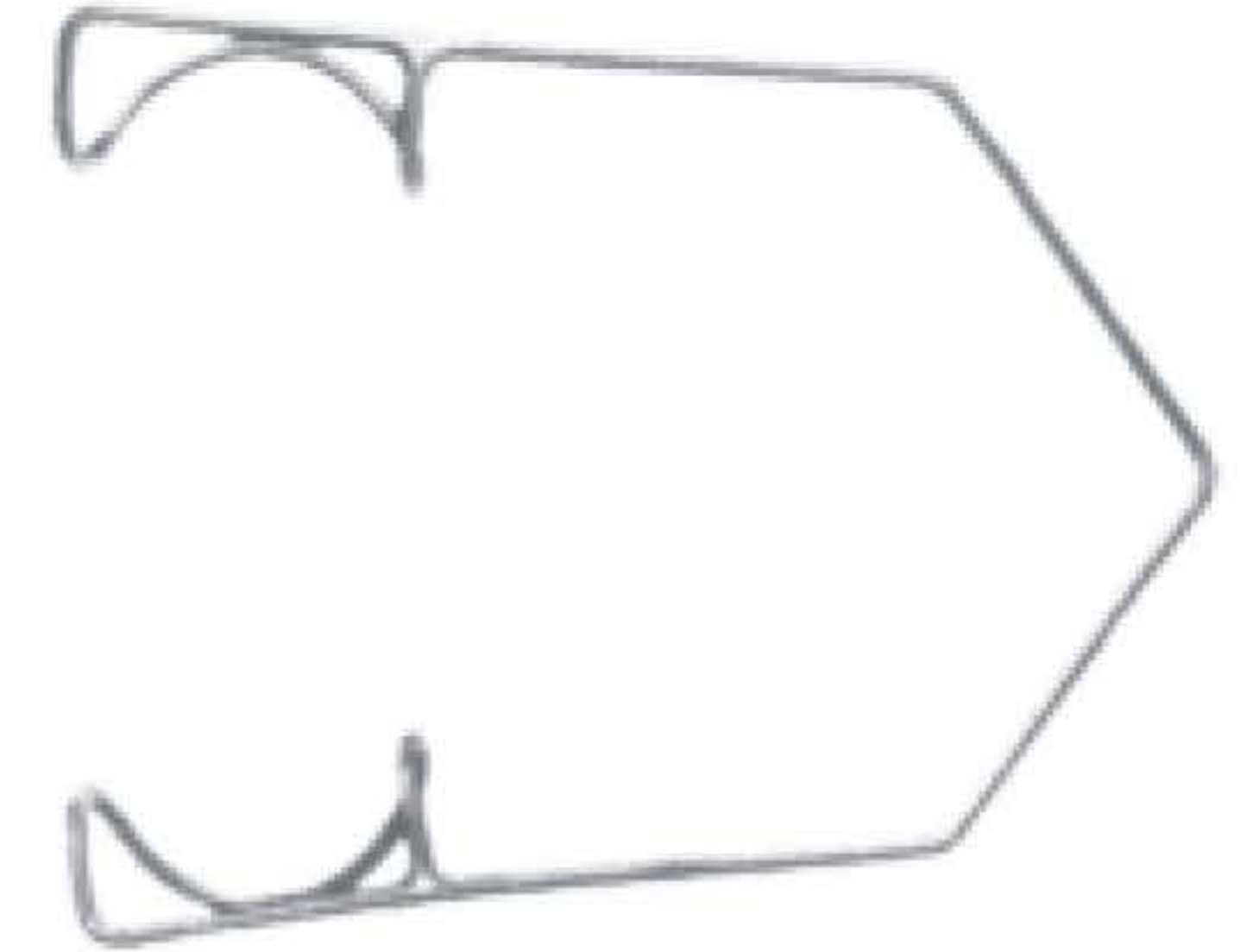

Barraquer Wire Speculum
 Heavy Wire

Catalog #	Blade Size
OP-012-10	15 mm

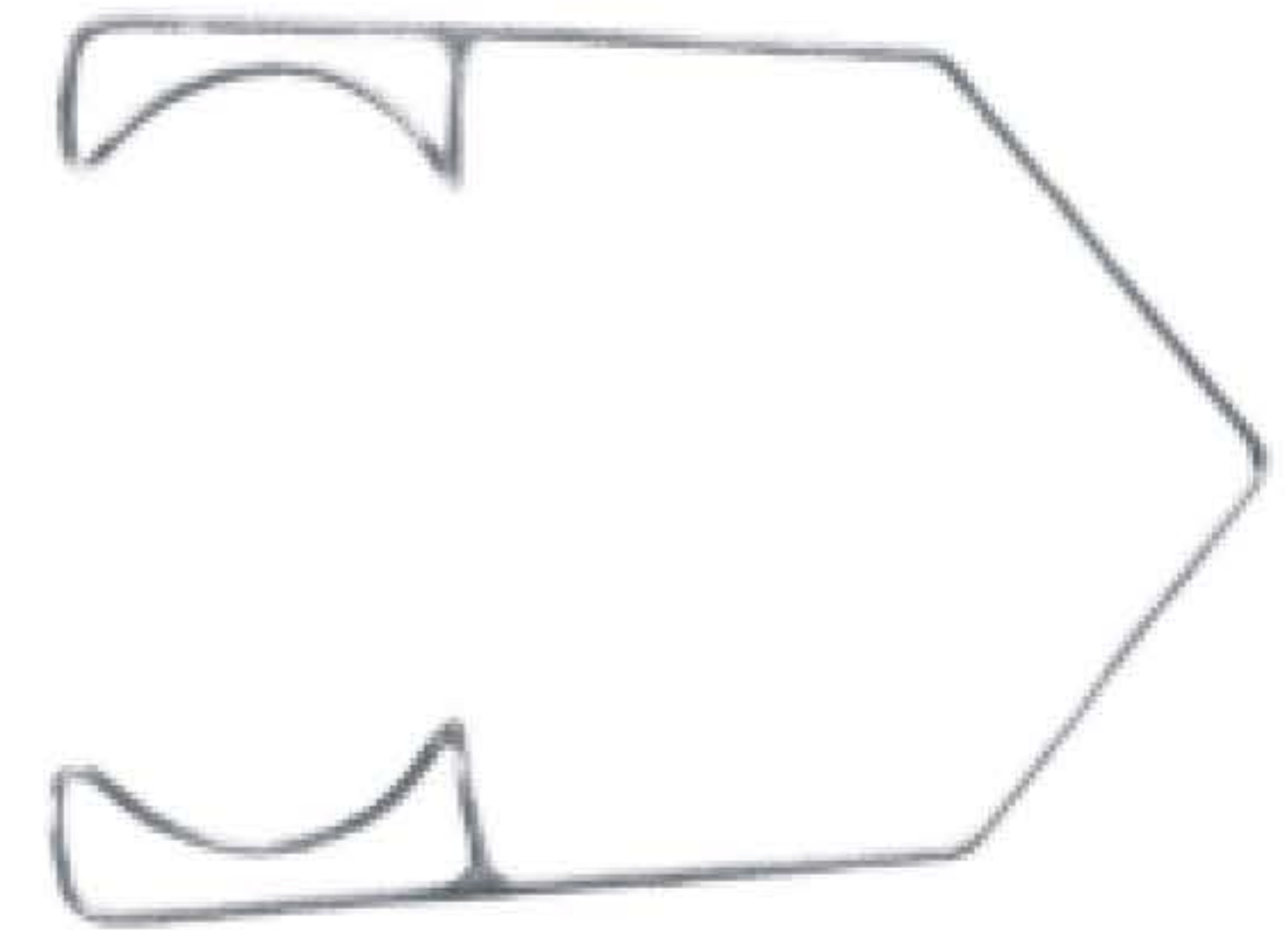

Barraquer Wire Speculum
 Solid Blades

Catalog #	Blade Size
OP-020-10	10 mm
OP-020-15	15 mm

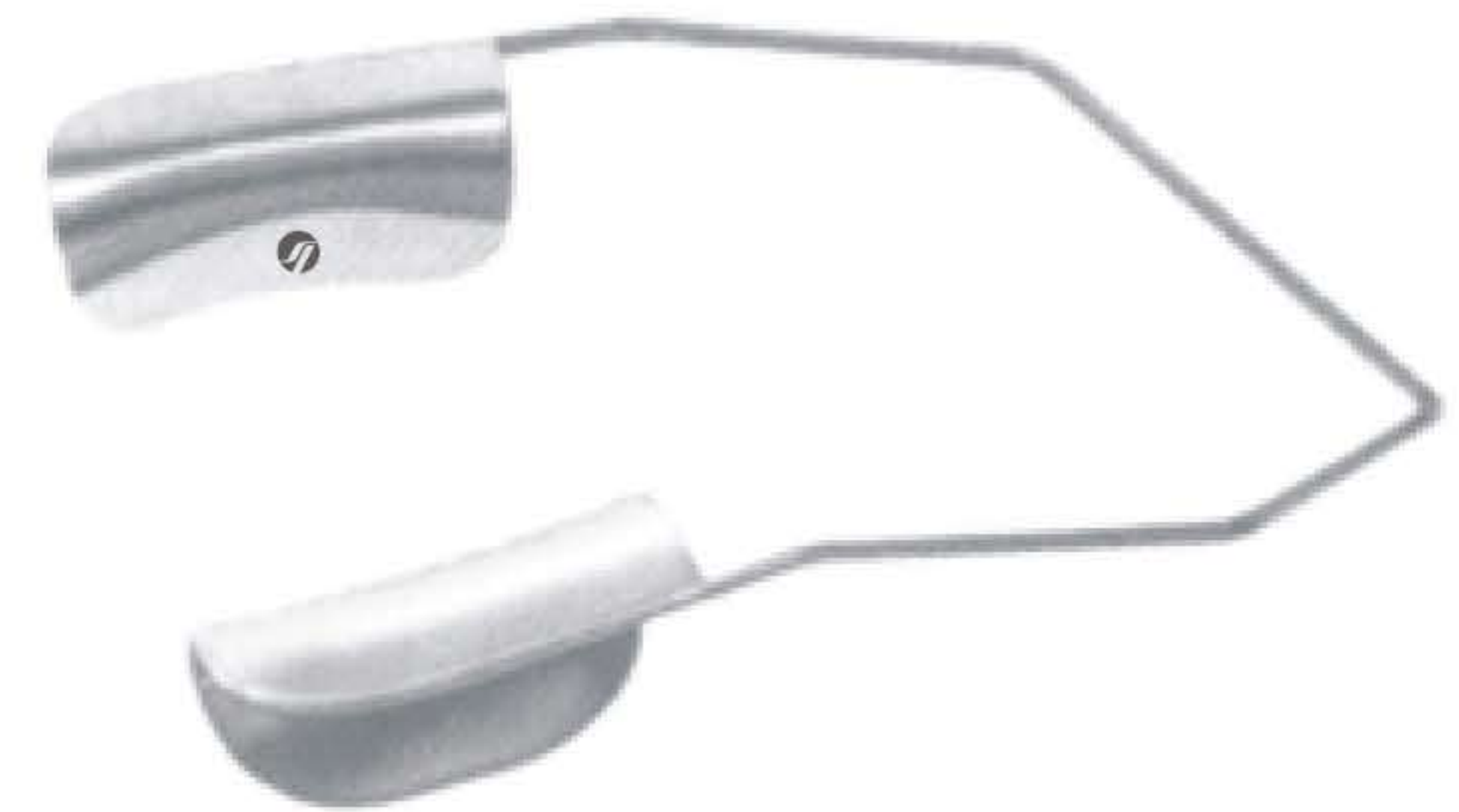

Feaster Wire Speculum
 Solid Blades

Catalog #	Blade Size
OP-022-20	20 mm



Kartz-Barraquer Wire Speculum
 With Open Blades, Standard Wire

Catalog #	Blade Size
OP-030-13	13 mm
OP-030-15	15 mm

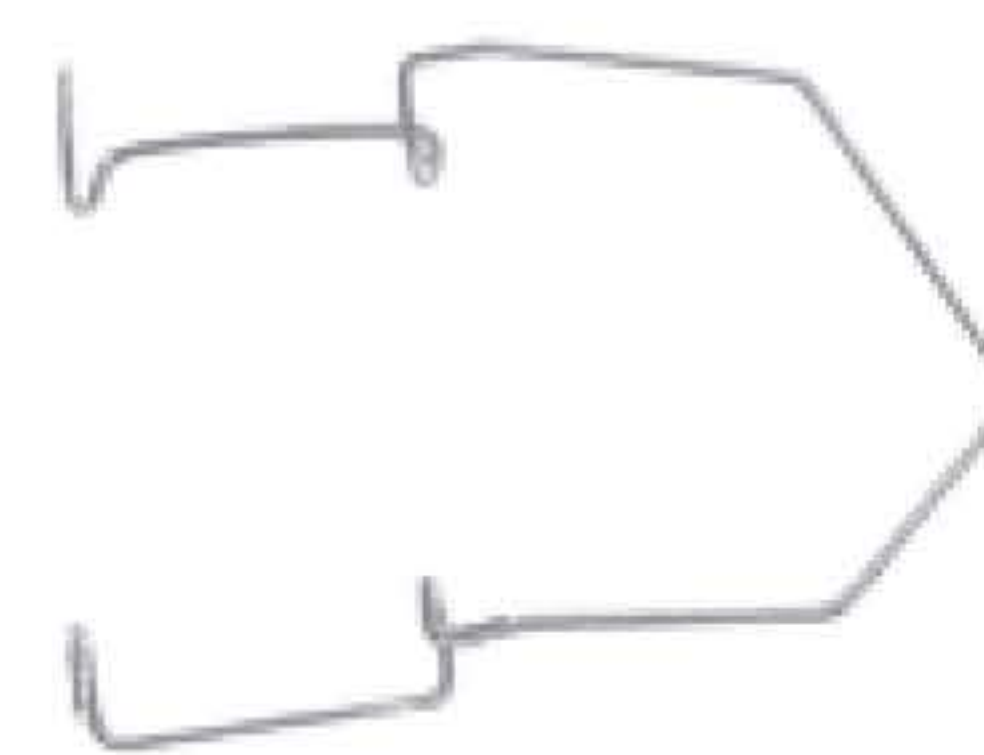

OP-030-13

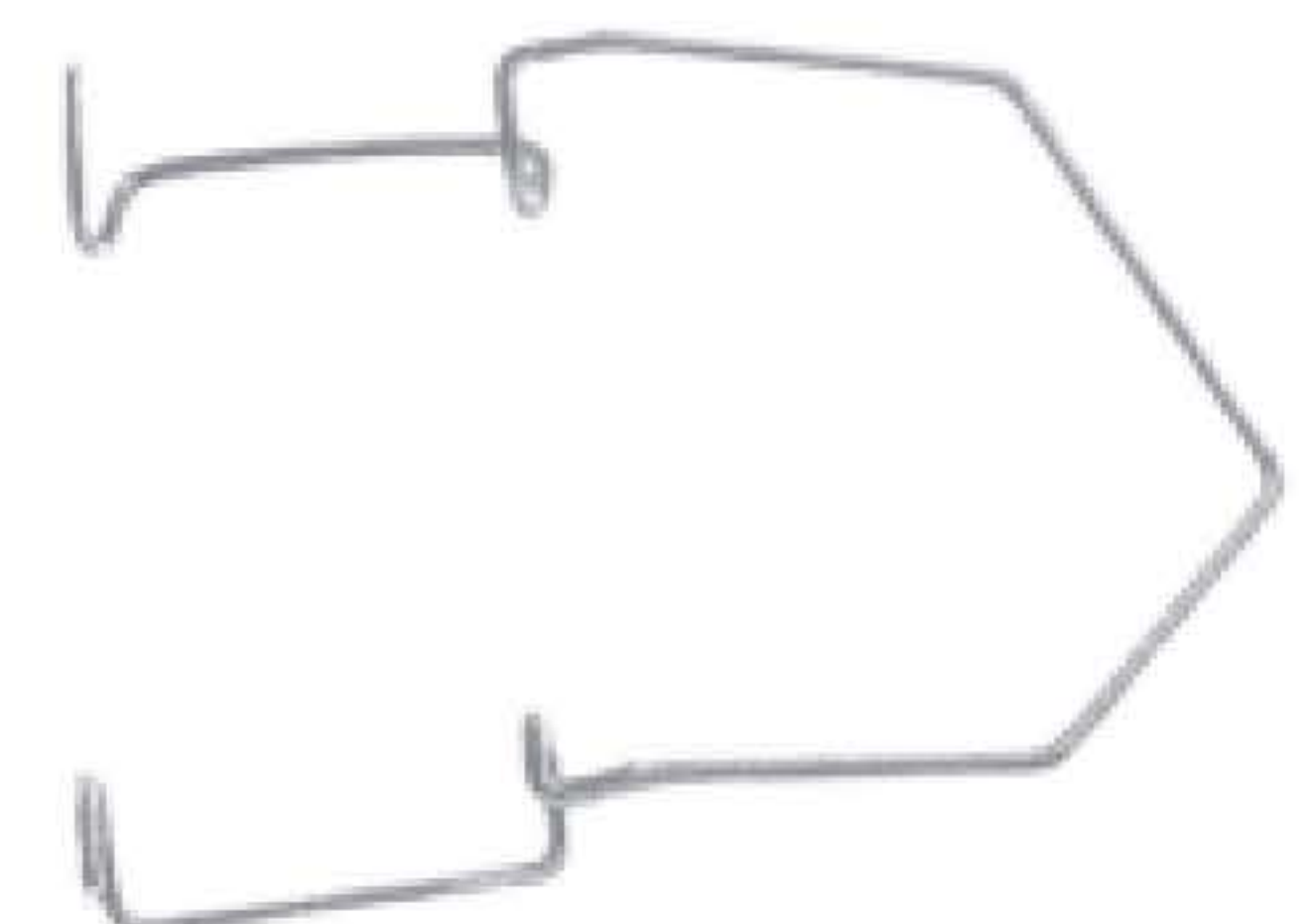

OP-030-15

Eye Speculum
 Lidsperrer
 Blefarostatos
 Blépharostats
 Blefarostati

Kartz-Barraquer Wire Speculum
 With Open Blades, Heavy Wire

Catalog #	Blade Size
OP-032-15	15 mm

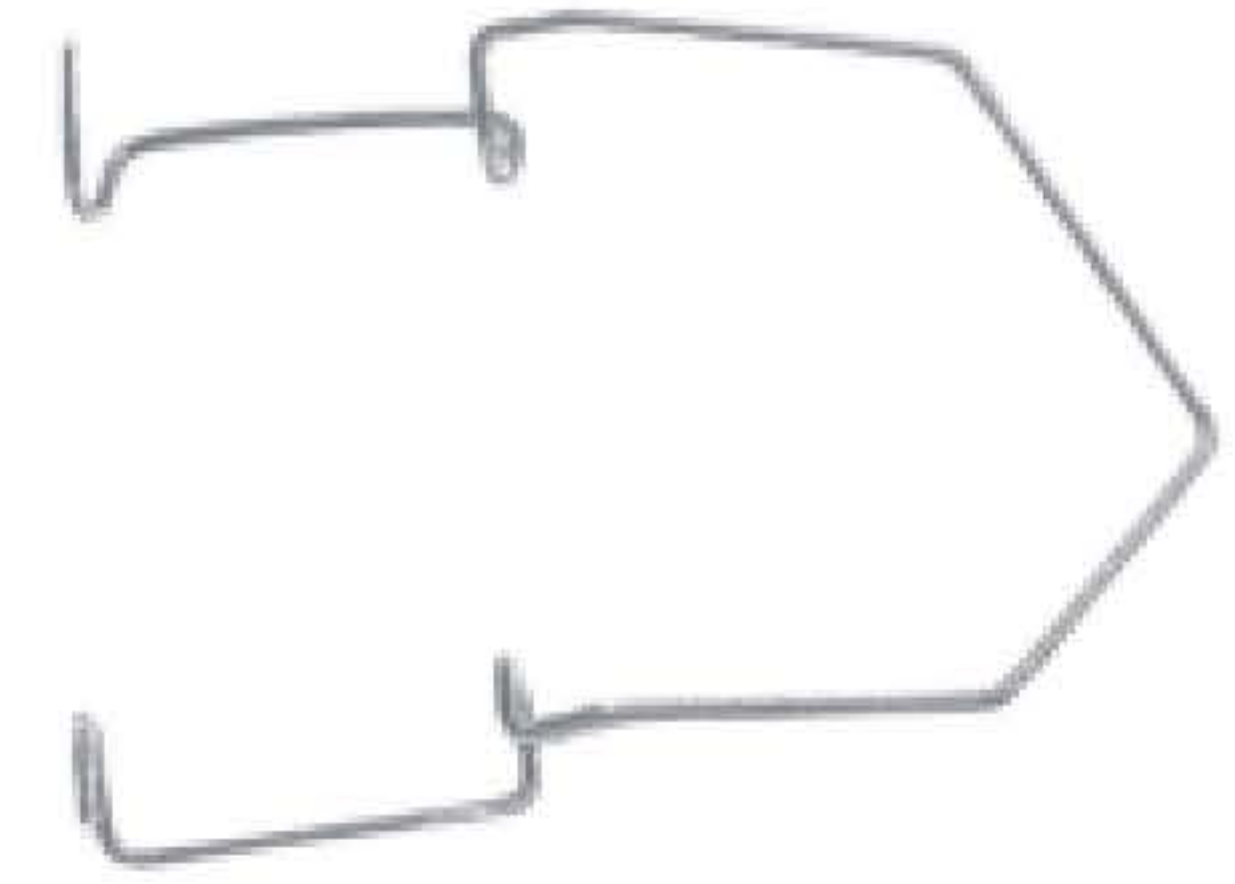

Frankel Infant Lid Speculum
 Adjustable

Catalog #	Blade Size
OP-040-10	10 mm



Alphonson Infant Lid Speculum
 With Finger Grip

Catalog #	Size
OP-042-00	N/A

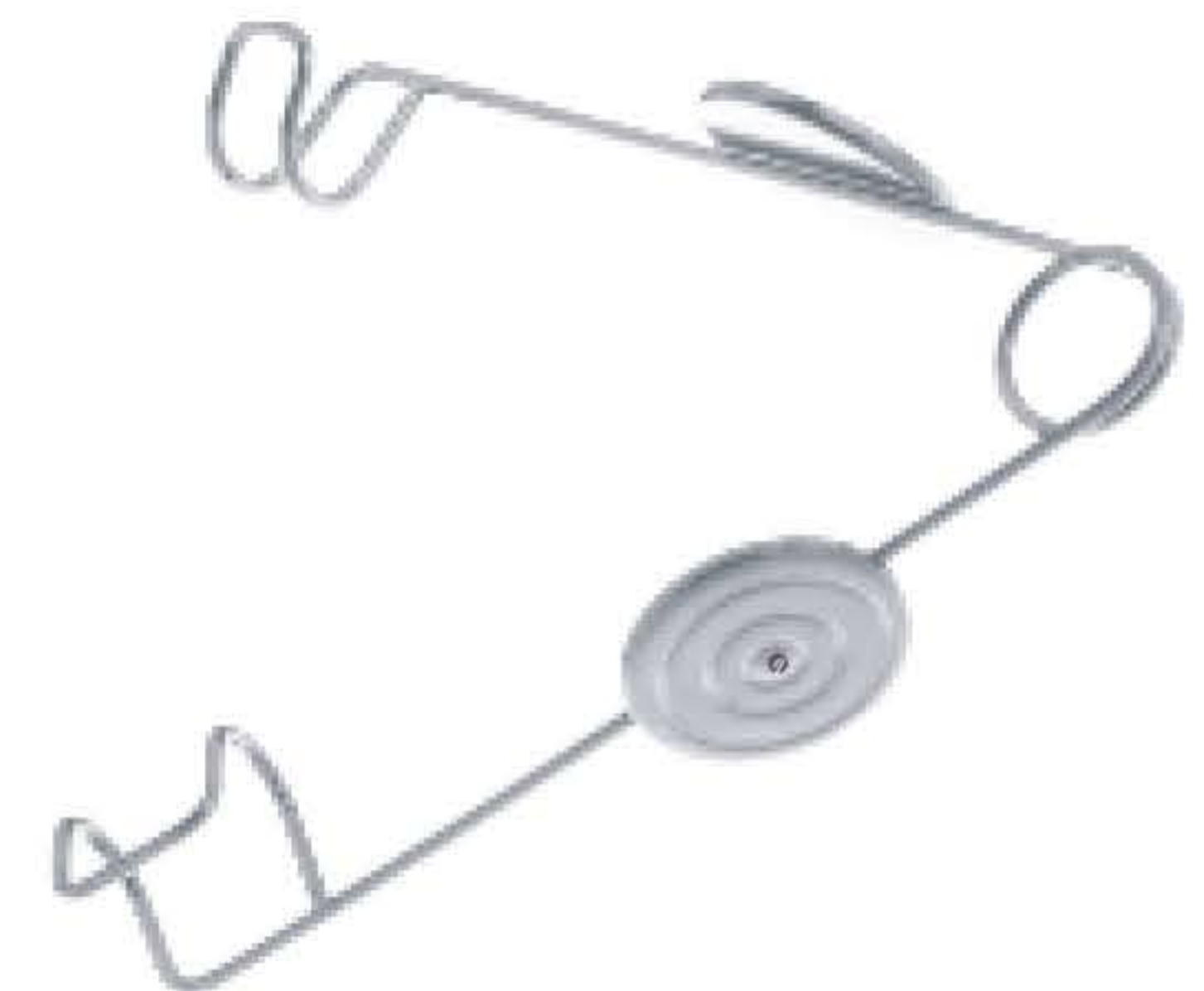

Lid Speculum (For Infants)

Catalog #	Blade Size
OP-046-00	4 mm

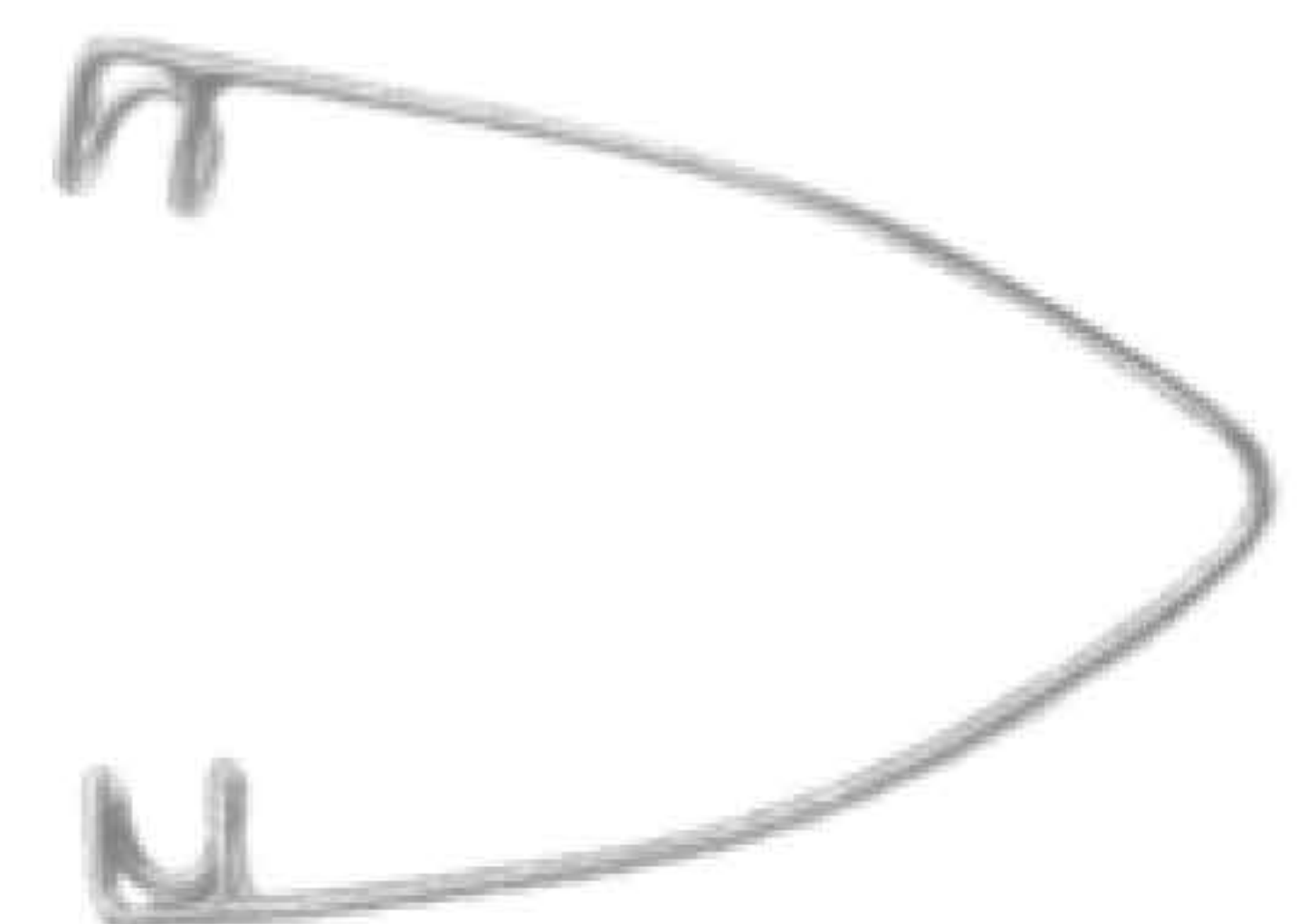

Barraquer Infant Lid Speculum

Catalog #	Blade Size
OP-050-09	9 mm

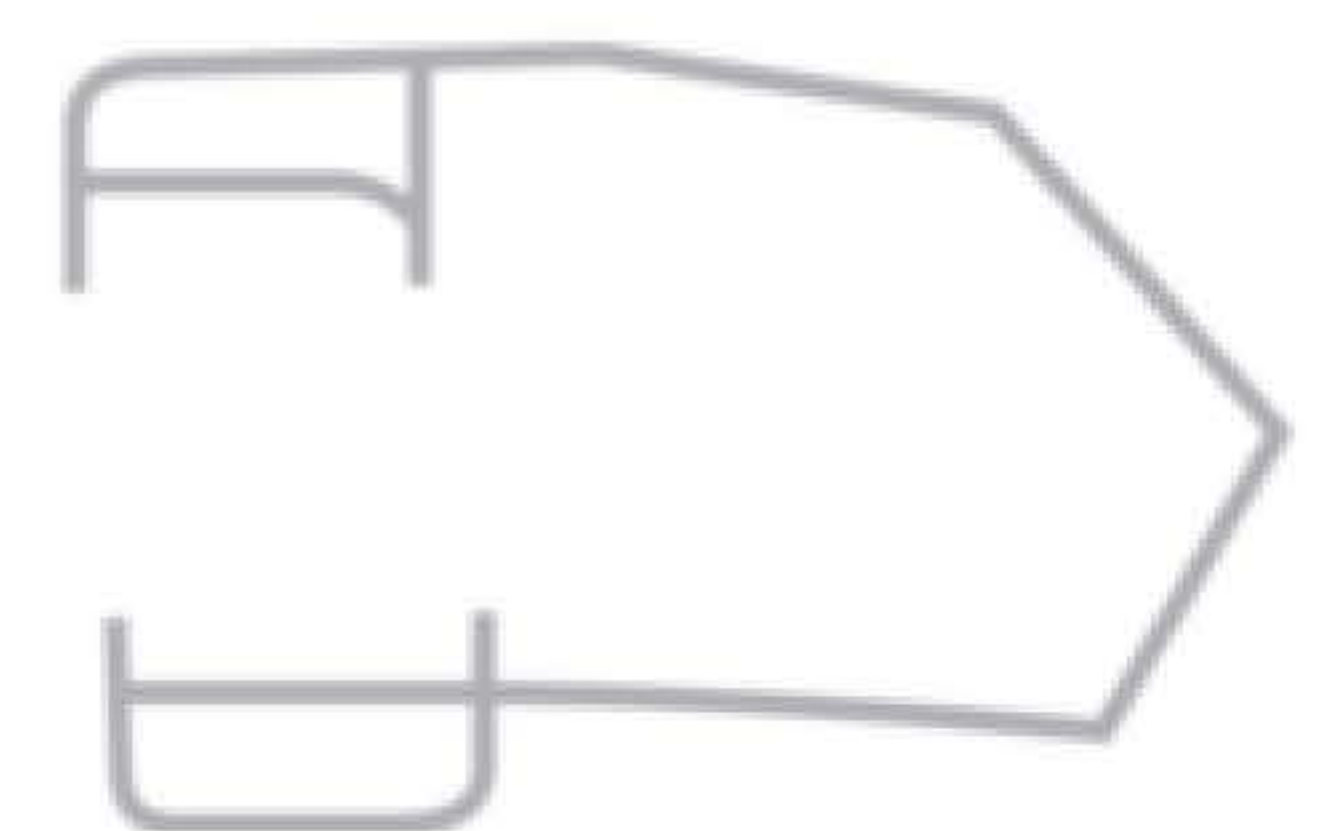

Eye Speculum
 Lidsperrer
 Blefarostatos
 Blépharostats
 Blefarostati

Cook Eye Speculum

Catalog #	Blade Size
OP-060-08	8 mm
OP-060-11	11 mm
OP-060-15	15 mm



Murdoch Eye Speculum

Catalog #	Blade Size
OP-064-12	12 mm
OP-064-15	15 mm



Melinger Eye Speculum

Catalog #	Blade Size
OP-070-15	15 mm



**Williams Eye Speculum
 With Locking Screw**

Catalog #	Blade Size
OP-074-11	11 mm
OP-074-15	15 mm



**Lancaster Eye Speculum
 Adjustable**

Catalog #	Blade Size
OP-076-16	16 mm



Eye Speculum
Lidsperrer
Blefarostatos
Blépharostats
Blefarostati

Lester-Burch Eye Speculum
Adjustable

Catalog #	Size
OP-078-00	Standard



Tanna-Lieberman Eye Speculum
Adjustable

Catalog #	Blade Size
OP-081-15	15 mm

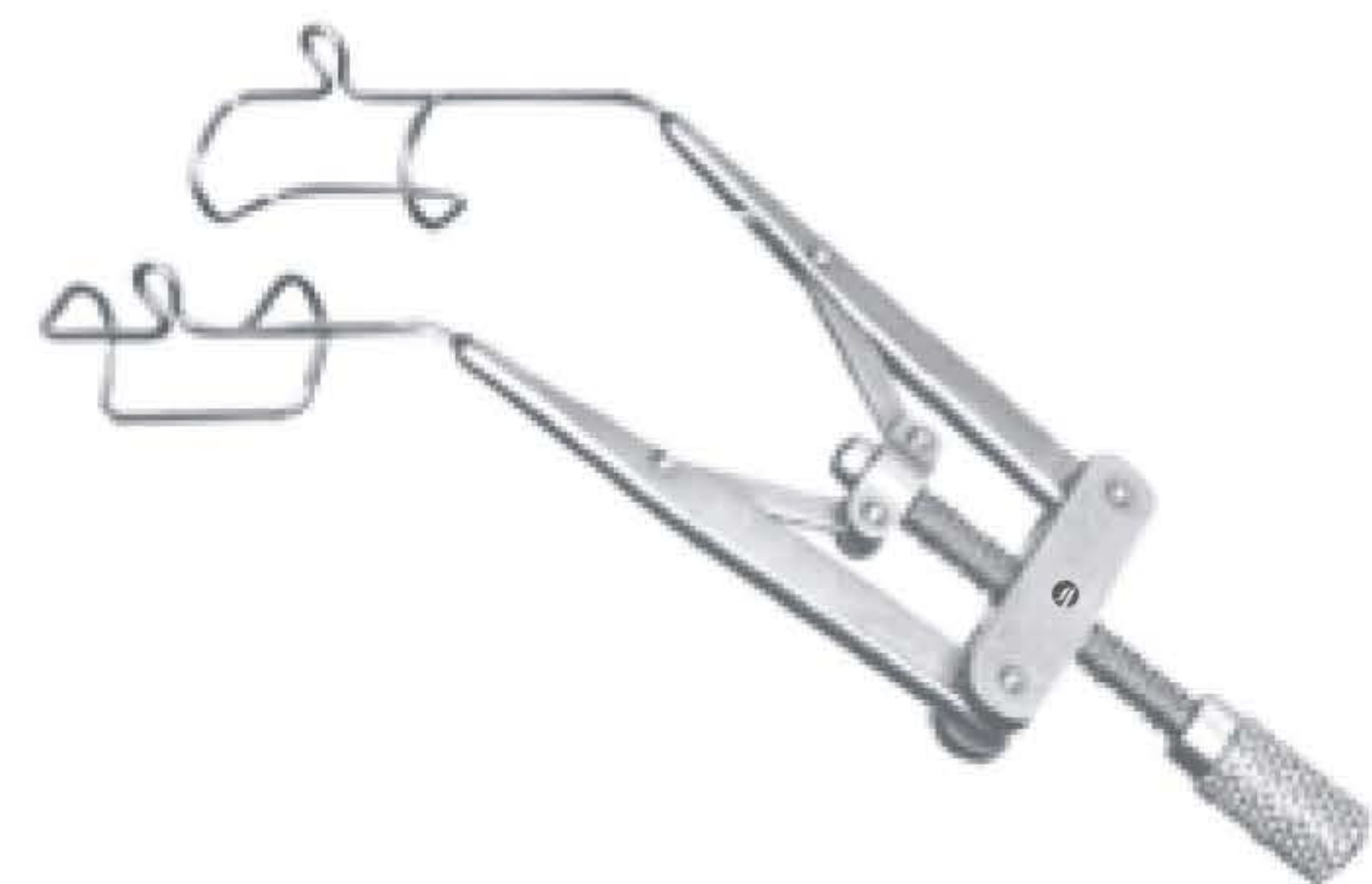

Lieberman Eye Speculum
Adjustable

Catalog #	Blade Size
OP-083-10	10 mm
OP-083-15	15 mm



Lieberman Eye Speculum
Adjustable

Catalog #	Blade Size
OP-085-15	15 mm



Lieberman Eye Speculum
Adjustable, Solid Blades

Catalog #	Blade Size
OP-087-10	10 mm



Eye Speculum, Scleral Fixation Ring
 Lidsperrer, Scleral Fixation Ring
 Blefarostatos, Anillo de fijación escleral
 Blépharostats, Anneau de fixation scléral
 Blefarostati, Sclerale Fixation Anello

Lieberman Eye Speculum
 Adjustable



Catalog #	Blade Size
OP-087-15	15 mm

Castroviejo Eye Speculum
 Adjustable Mechanism



Catalog #	Blade Size
OP-091-14	14 mm
OP-091-16	16 mm

Flieringa Scleral Fixation Ring
 Set of 9 Ref: OP-100-14 to OP-100-22

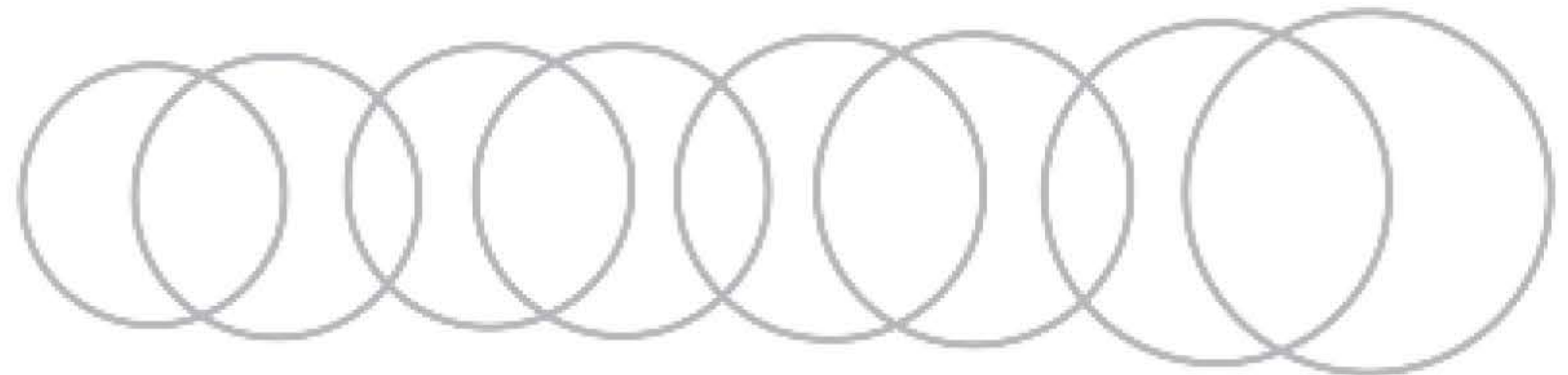

Catalog #	Size
OP-100-00	Standard

Scleral Fixation Ring, Depressors
 Scleral Fixation Ring, Depressors
 Anillo de fijación escleral, Depresores
 Anneau de fixation scléral, Dépresseurs
 Sclerale Fixation Anello, Depressore

Flieringa Scleral Fixation Ring

Catalog #	Blade Size
OP-100-14	14 mm
OP-100-15	15 mm
OP-100-16	16 mm
OP-100-17	17 mm
OP-100-18	18 mm
OP-100-19	19 mm
OP-100-20	20 mm
OP-100-21	21 mm
OP-100-22	22 mm

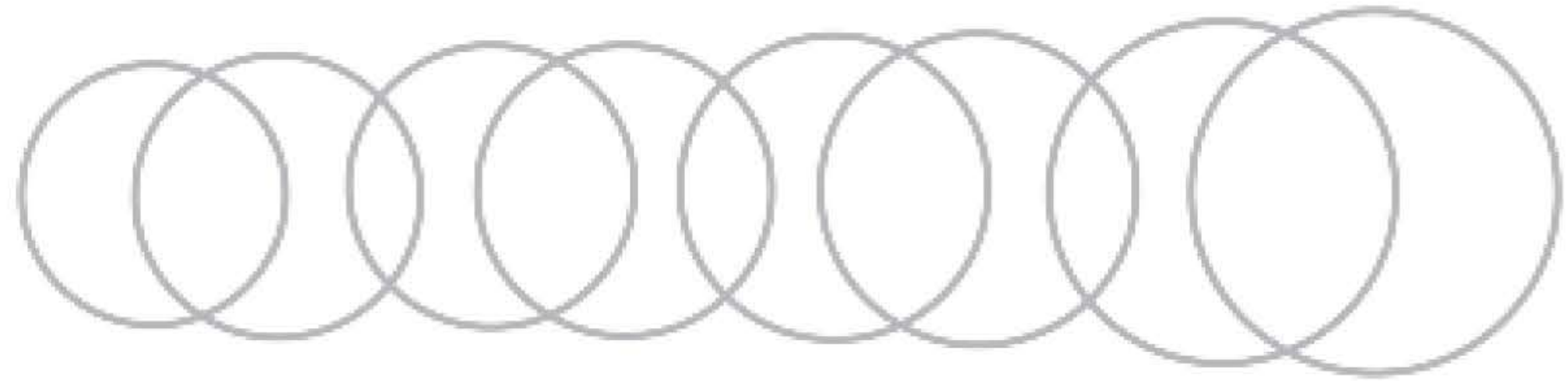

McNeill-Goldman Scleral Fixation Ring & Blepharostat
 Small, I.D

Catalog #	Blade Size
OP-111-15	15 mm

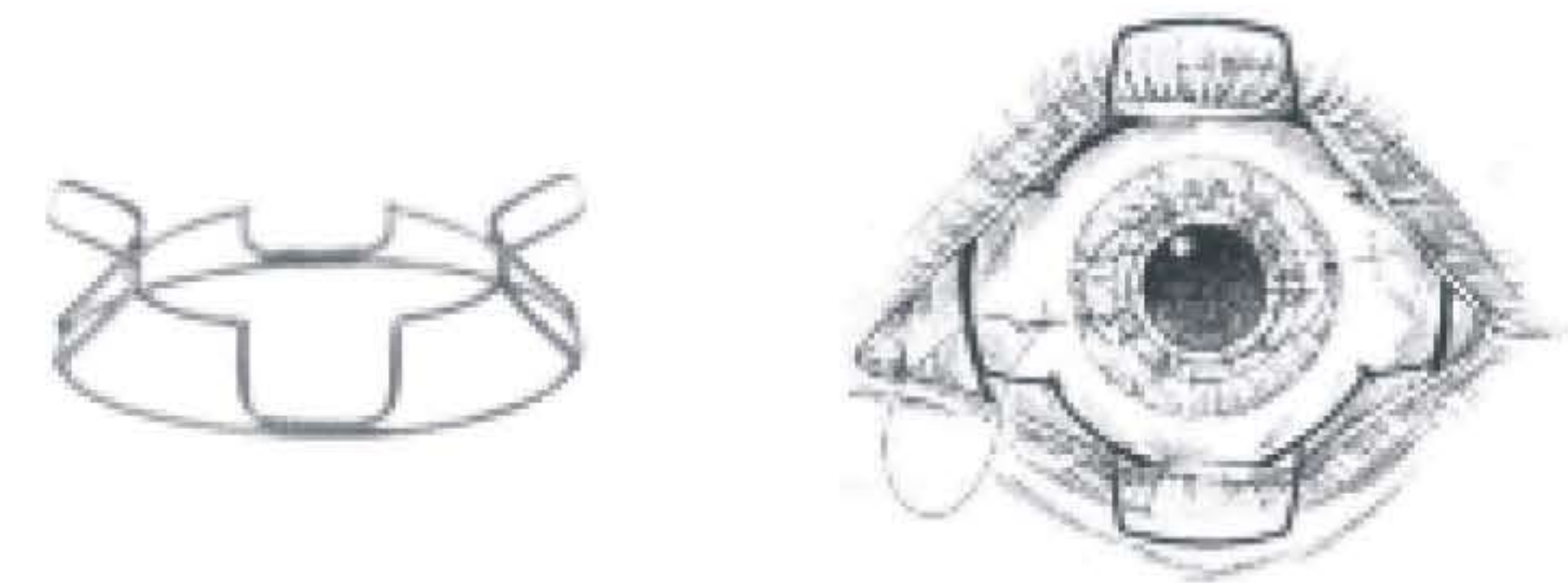

McNeill-Goldman Scleral Fixation Ring & Blepharostat
 Medium, I.D

Catalog #	Blade Size
OP-111-16	16 mm

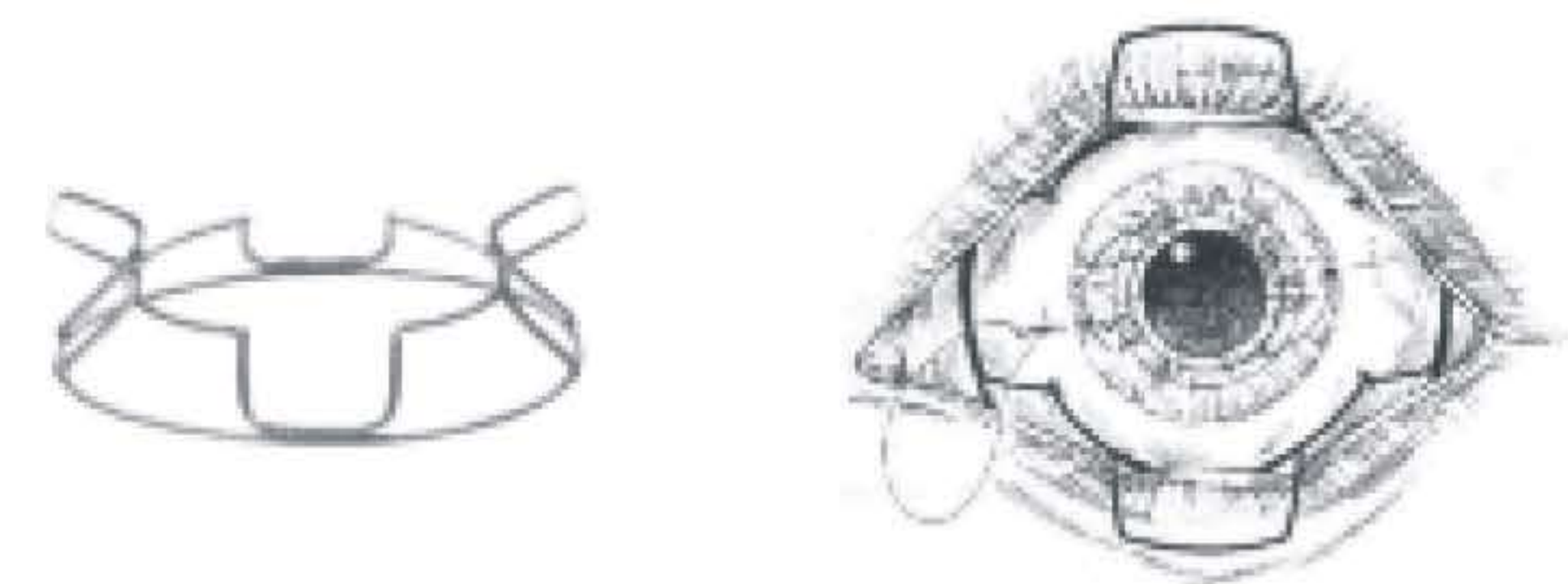

McNeill-Goldman Scleral Fixation Ring & Blepharostat
 Large, I.D

Catalog #	Blade Size
OP-111-17	17 mm

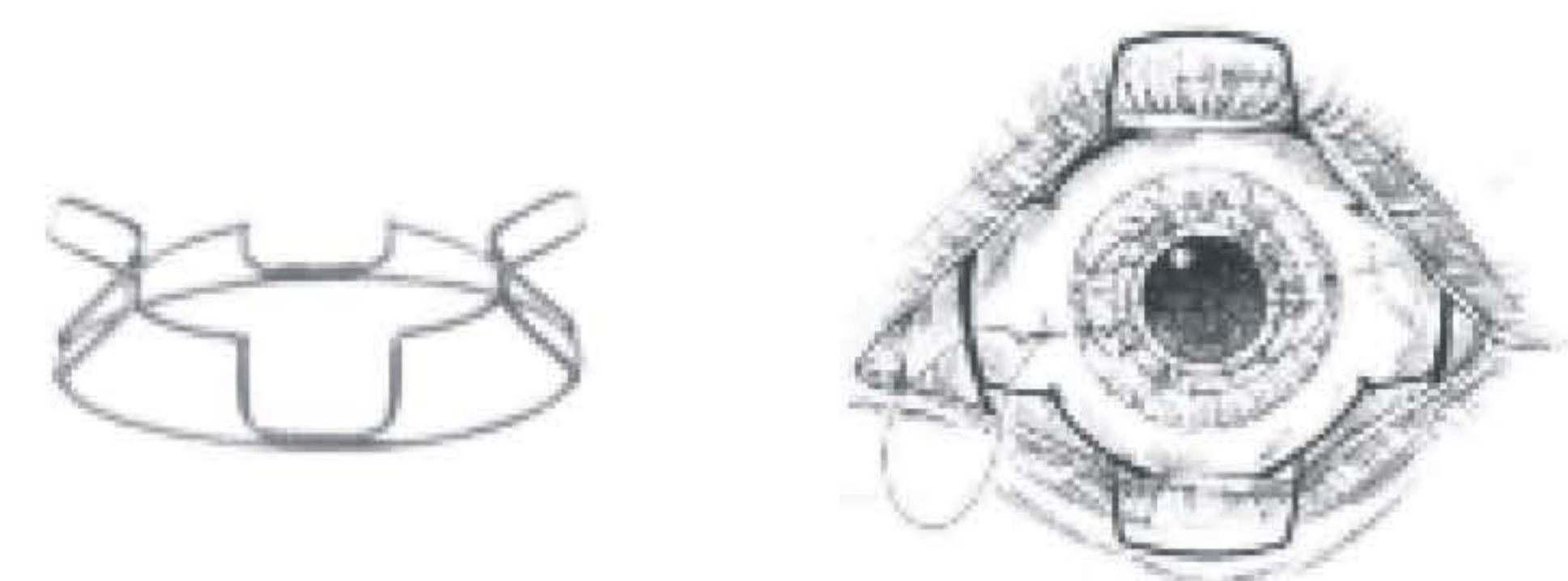

Depressors, Eyelid Retractors
 Depressors, Augenlid Wundhaken
 Depresores, Retractor de párpados
 Dépresseurs, Écarteur de paupières
 Depressore, Palpebra Divaricatore

Gass Scleral Marker

Catalog #	Tip Diameter
OP-151-01	Ø 1.5 mm



Schepens Scleral Depressor
 Small Thimble

Catalog #	Tip Width
OP-153-01	7 mm



Schepens Scleral Depressor
 Medium Thimble

Catalog #	Tip Width
OP-153-02	7 mm



Schepens Scleral Depressor
 Large Thimble

Catalog #	Tip Width
OP-153-03	7 mm



Schoket Scleral Depressor
 Double End With Clip



Catalog #	Size
OP-160-14	14 cm (5 1/2")

Eyelid Retractors
 Augenlid Wundhaken
 Retractor de párpados
 Écarteur de paupières
 Palpebra Divaricatore

Schepens Orbital Retractor



Catalog #	Size
OP-171-15	15 cm (6")

Jaffe Wire Lid Retractor
 Pair



Catalog #	Blade Size
OP-173-13	13 mm
OP-173-15	15 mm

OP-173-13, 13 mm

OP-173-15, 15 mm

Desmarres Lid Retractor
 Thin Solid Blades



OP-175-11

OP-175-15

OP-175-13

OP-175-17

Catalog #	Size, Blade Size, Profile
OP-175-11	13 cm (5"), 11 mm, Size 0
OP-175-13	13 cm (5"), 13 mm, Size 1
OP-175-15	13 cm (5"), 15 mm, Size 2
OP-175-17	13 cm (5"), 17 mm, Size 3



Scleral Shield

Set of 2 Ref: OP-180-01 to OP-180-02



Catalog #	Size
OP-180-00	Standard

Scleral Shield
 Pair



Catalog #	Blade Size, Profile
OP-180-01	20 x 28 mm, Small
OP-180-02	22 x 30 mm, Large

Eyelid Retractors
 Augenlid Wundhaken
 Retractor de párpados
 Écarteur de paupières
 Palpebra Divaricatore

Jaeger Lid Plate
 Stainless Steel



Catalog #	Size
OP-192-11	11 cm (4 1/4")

Wright Fascia Needle
 Oval Hole



Catalog #	Size, Width, Length
OP-197-14	14 cm (5 1/2"), 1 x 6 mm

Walton Conjunctiva Retractor
 Thin Solid Blade



Catalog #	Size, Blade Width
OP-201-12	12.5 (5"), 6 mm

Helveston Tissue Retractor
 Thin Curved Blade



Catalog #	Size, Blade Width
OP-211-07	12.5 (5"), 7 mm
OP-211-09	12.5 (5"), 9 mm
OP-211-11	6.5 (2 1/2"), 11 mm

Stevenson Lacrimal Sac Retractor
 3 x 3 Blunt Prongs, Adjustable



Catalog #	Size
OP-220-00	Standard

Keratome
Keratome
Queratomos
Kératotomes
Cheratomo

Stevenson Lacrimal Sac Retractor
Solid Blades With Serrated Edge, Adjustable

Catalog #	Blade Size
OP-222-00	13 mm



Agricola Lacrimal Sac Retractor
3 x 3 Blunt Prongs

Catalog #	Size
OP-226-00	Standard

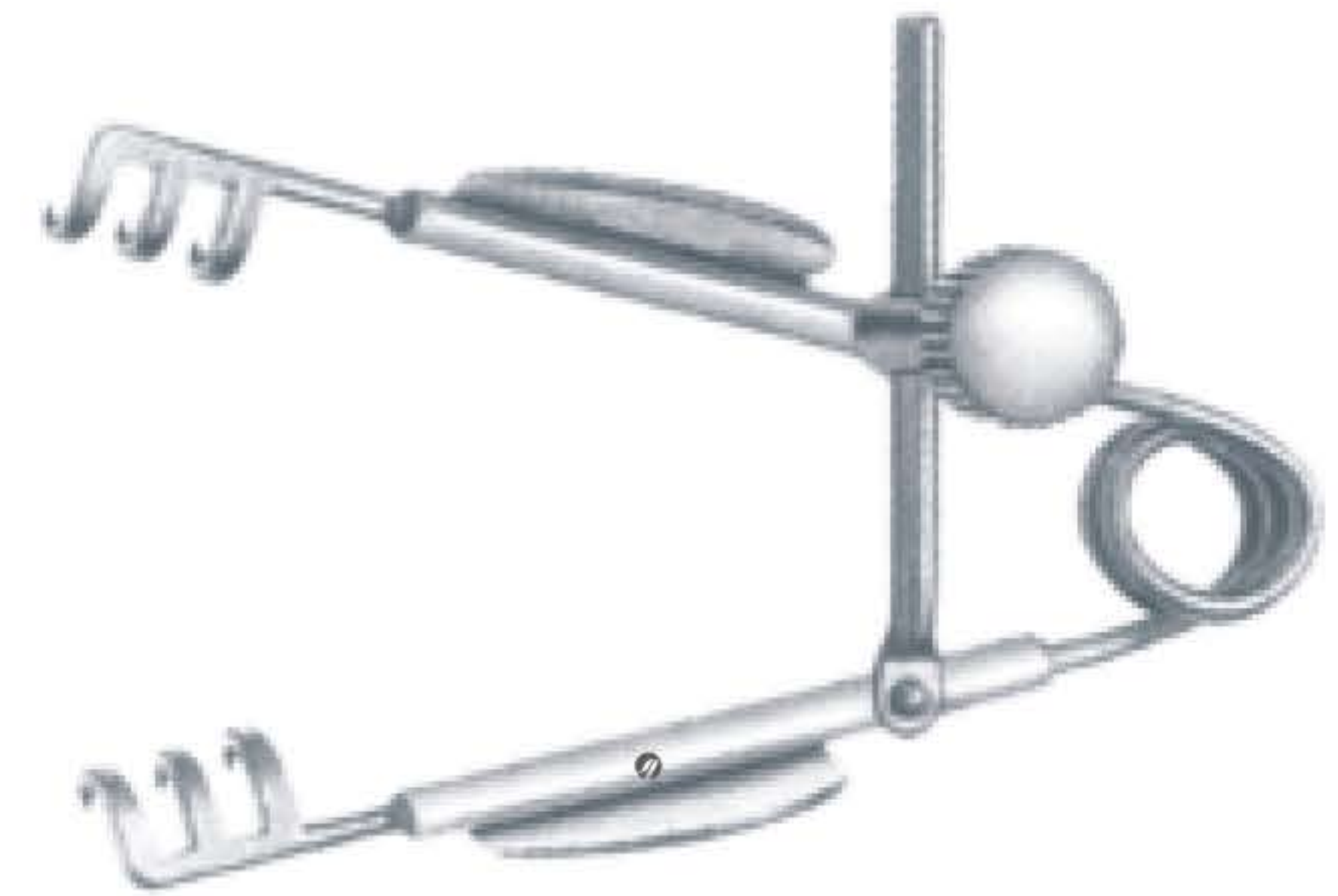

Jaeger Keratome
Straight

Catalog #	Size, Profile
OP-240-01	13 cm (5"), Fig. 1
OP-240-02	13 cm (5"), Fig. 2
OP-240-03	13 cm (5"), Fig. 3



OP-240-01, Fig. 1 OP-240-02, Fig. 2 OP-240-03, Fig. 3

Jaeger Keratome
Angled

Catalog #	Size, Profile
OP-241-01	13 cm (5"), Fig. 1
OP-241-02	13 cm (5"), Fig. 2
OP-241-03	13 cm (5"), Fig. 3



OP-241-01, Fig. 1 OP-241-02, Fig. 2 OP-241-03, Fig. 3

Took Corneal Knife
Straight, Blade With Curved Cutting Edge

Catalog #	Size
OP-250-11	11 cm (4 1/4")



Corneal Knives
 Hornhaut-Messer
 Cuchillos corneales
 Couteaux cornée
 Coltelli corneali

Corneal Dissector
 Angled, Straight Blade



Catalog #	Size
OP-253-12	12 cm (4 3/4")

Corneal Dissector
 Angled, Curved Blade



Catalog #	Size
OP-255-12	12 cm (4 3/4")

Gill Corneal Knife
 Curved Cutting Edge, Straight



Catalog #	Size
OP-260-12	12.5 cm (5")

Gill Corneal Knife
 Curved Cutting Edge, Light Curved



Catalog #	Size
OP-261-12	12.5 cm (5")

Fukasaku Hockey Knife
 Sharp Front Edge, Semi Sharp Bottom Edge



Catalog #	Size, Front Edge, Bottom Edge
OP-265-12	12 cm (4 3/4"), 3 mm, 6 mm

Gouges and Spuds
 Hohlmeißel und meißel
 Gubias para Cinceles
 Gouges et Ciseaux-burins
 Sgorbie e Scalpelli

Golf Club Foreign Body Spud
 Angled, Lightly Rounded Tip



Catalog #	Size
OP-271-12	12 cm (4 ¾")

Francis Foreign Body Spud
 Angled, Flag Shaped Tip



Catalog #	Size
OP-273-12	12 cm (4 ¾")

Ellis Foreign Body Spud
 Lightly Curved and Rounded Tip



Catalog #	Size
OP-275-11	11 cm (4 ¼")

Spud & Guage
 In Reversible Handle

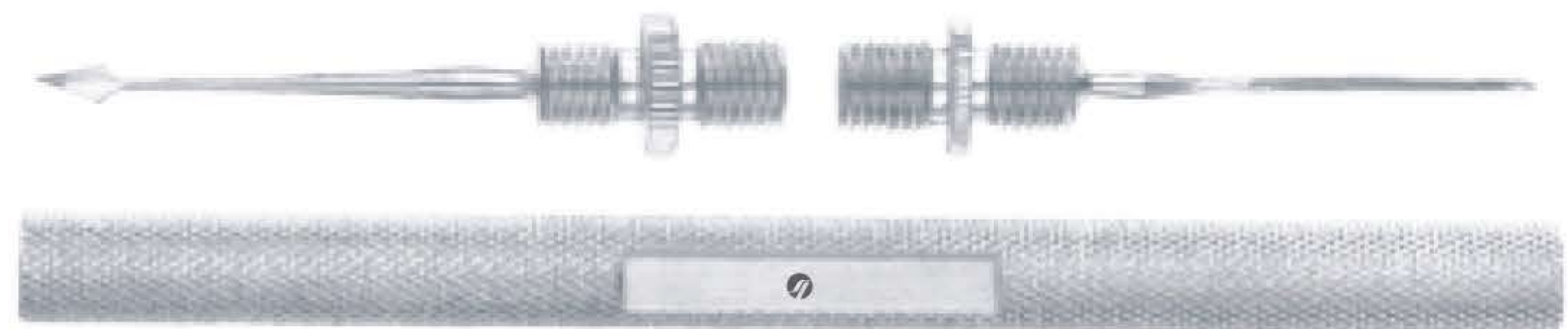

Catalog #	Size
OP-280-18	18 cm (7")

Wills Eye Hospital Foreign Body Spud & Burr
 Delicately Curved



Catalog #	Size
OP-283-11	11 cm (4 ¼")

Diamond Knives
 Diamantmesser
 Bisturi de diamante
 Couteaux de diamant
 Coltelli di diamanti

LRI Diamond Step Knife
 Pre-Calibrated



Catalog #	Size
OP-300-12	12 cm (5")

LRI Diamond Micrometer Knife



Catalog #	Size
OP-302-12	12 cm (4 3/4")

AK Diamond Knife



Catalog #	Size
OP-305-11	11 cm (4 1/4")

Diamond Micrometer Knife
 45 ° Cutting Edge

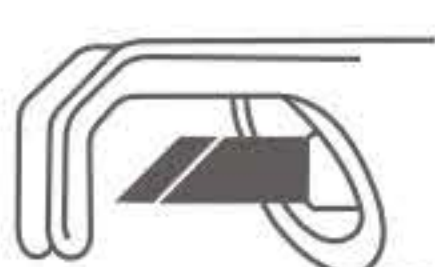

Catalog #	Size, Width
OP-311-01	13 cm (5"), 1.0 mm

Diamond Micrometer Knife
 Double Vertical and 45 ° Cutting Edge



Catalog #	Size, Width
OP-311-02	13 cm (5"), 1.0 mm

Diamond Knives
 Diamantmesser
 Bisturi de diamante
 Couteaux de diamant
 Coltelli di diamanti

Diamond Micrometer Knife
 Triple Vertical and 15 ° Cutting Edge

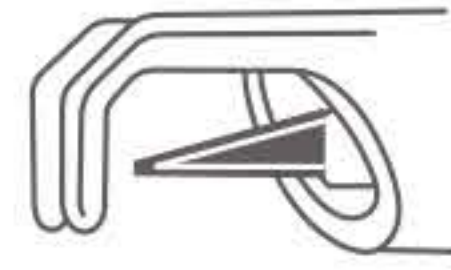

Catalog #	Size, Width
OP-311-03	13 cm (5"), 1.0 mm

Diamond Knife
 30° Cutting Edge

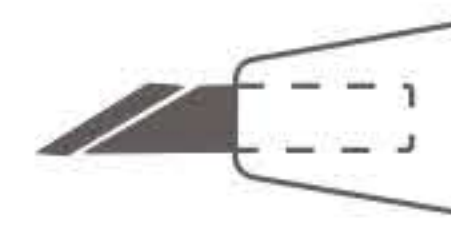

Catalog #	Size, Width
OP-316-01	12.5 cm (5"), 1.0 mm

Diamond Knife
 45° Cutting Edge

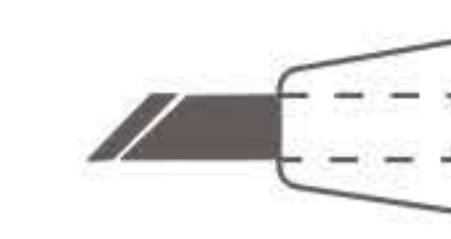

Catalog #	Size, Width
OP-316-02	12.5 cm (5"), 1.0 mm

Diamond Knife
 Tri-Facet Cutting Edge

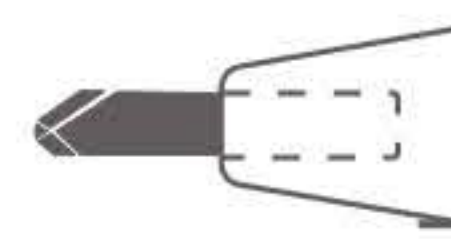

Catalog #	Size, Width
OP-316-03	12.5 cm (5"), 1.0 mm

Diamond Knife
 Spear Cutting Edge

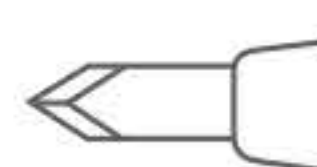

Catalog #	Size, Width
OP-316-04	12.5 cm (5"), 1.0 mm

Diamond Knives
 Diamantmesser
 Bisturí de diamante
 Couteaux de diamant
 Coltelli di diamanti

Diamond Knife
 10-Facet Cutting Edge

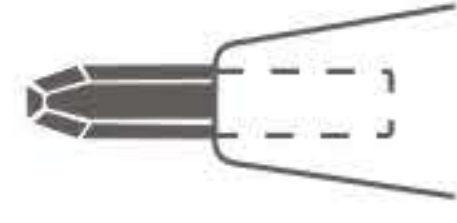

Catalog #	Size, Width
OP-316-05	12.5 cm (5"), 1.0 mm

Diamond Knife
 Single 45° Cutting Edge

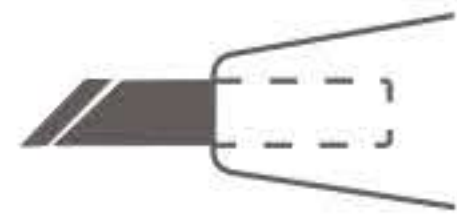

Catalog #	Size, Width
OP-320-01	12 cm (4 3/4"), 1.0 mm

Diamond Knife
 Tri-Facet Cutting Edge

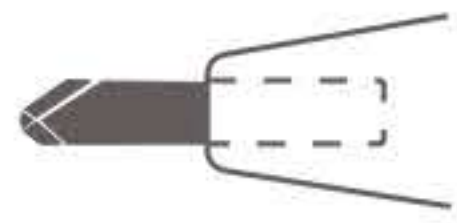

Catalog #	Size, Width
OP-320-02	12 cm (4 3/4"), 1.0 mm

Diamond Knife
 10-Facet Cutting Edge

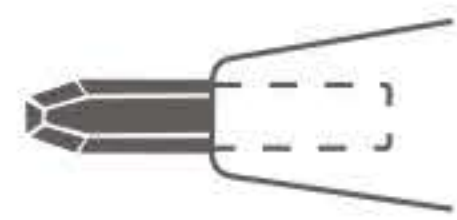

Catalog #	Size, Width
OP-320-03	12 cm (4 3/4"), 1.0 mm

Crescent Diamond Knife

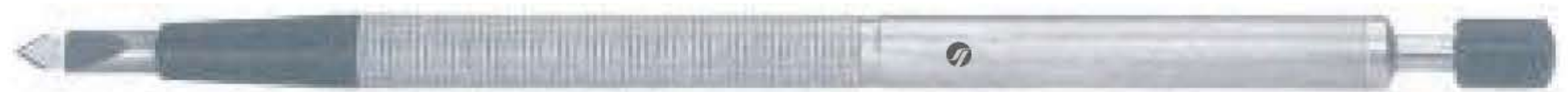

Catalog #	Size, Width
OP-331-25	11.5 cm (4 1/2"), 2.5 mm

Diamond Knives, Trephines
 Diamantmesser, Trephinen
 Bisturí de diamante, Trépanos
 Couteaux de diamant, Tréfans
 Coltelli di diamanti, Trepani

Diamond Phaco Knife
 Straight, Keratome Shaped

Catalog #	Size, Width
OP-340-28	13 cm (5"), 2.8 mm
OP-340-30	13 cm (5"), 3.0 mm
OP-340-32	13 cm (5"), 3.2 mm



Diamond Phaco Knife
 Angled, Keratome Shaped

Catalog #	Size, Width
OP-341-25	13 cm (5"), 2.8 mm
OP-341-30	13 cm (5"), 3.0 mm
OP-341-32	13 cm (5"), 3.2 mm



Diamond Phaco Knife
 Keratome Shaped, 4 Cutting Edges

Catalog #	Size, Width
OP-351-25	13 cm (5"), 2.5 mm
OP-351-28	13 cm (5"), 2.8 mm
OP-351-30	13 cm (5"), 3.0 mm
OP-351-32	13 cm (5"), 3.2 mm



Diamond Phaco Knife
 Trapeziod Cutting Edge

Catalog #	Size, Width
OP-355-27	12 cm (4 3/4"), 2.7 mm to 3.2 mm



Trephines
 Trephinen
 Trépanos
 Tréfans
 Trepani

Elliot Scleral Trephine Blade

Catalog #	Size, Diameter
OP-370-10	3.5 cm (1 1/2"), Ø 1.0 mm
OP-370-15	3.5 cm (1 1/2"), Ø 1.5 mm
OP-370-20	3.5 cm (1 1/2"), Ø 2.0 mm



Elliot Handle

Catalog #	Size
OP-370-90	4.5 cm (1 3/4")

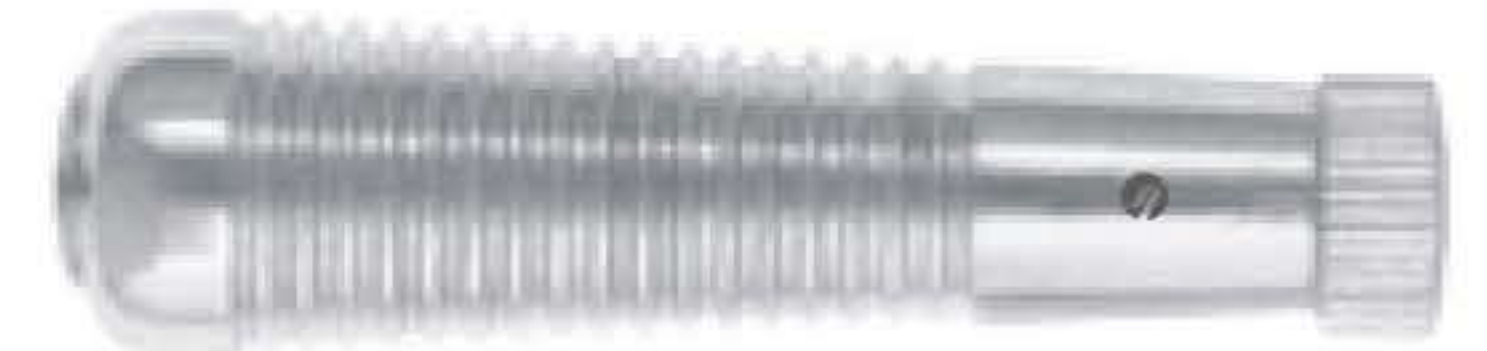

Camellin Lasek Trephine

Catalog #	Size, Diameter
OP-381-08	12 cm (4 3/4"), Ø 8 mm
OP-381-09	12 cm (4 3/4"), Ø 9 mm
OP-381-10	12 cm (4 3/4"), Ø 10 mm



Camellin Lasek Trephine & Alcohol Retaining Well

Catalog #	Size, Diameter
OP-385-08	12.5 cm (5"), Ø 8 mm, 8.5 mm
OP-385-09	12.5 cm (5"), Ø 9 mm, 9.5 mm
OP-385-10	12.5 cm (5"), Ø 10 mm, 10.5 mm



Trephines
 Trephinen
 Trépanos
 Trépan
 Trepani

Gass Corneoscleral Punch
 Rotatable

Catalog #	Diameter, Deep Bite
OP-391-00	Ø 1.5 mm, 0.75 mm

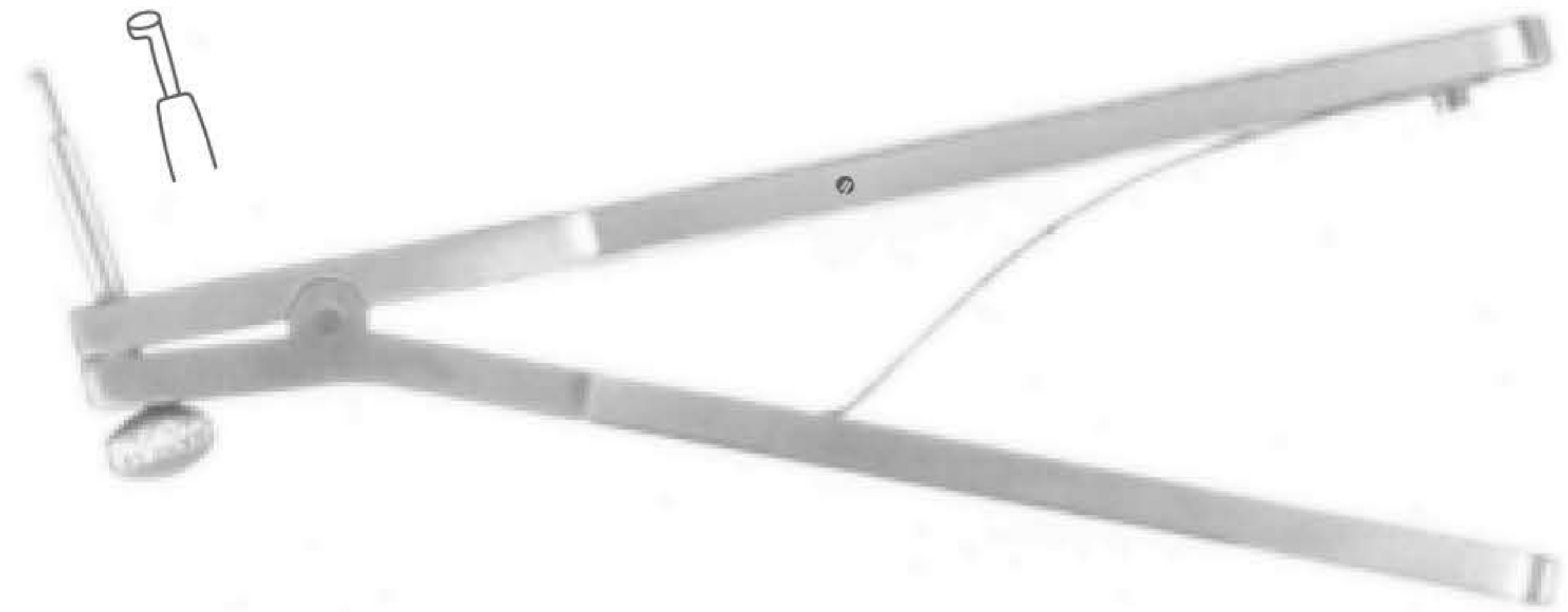

Luntz-Dodick Trabeclectomy Punch Complete
 With Puch Ref: OP-455-01

Catalog #	Diameter, Deep Bite
OP-395-00	Ø 1.0 mm, 0.5 mm



Luntz-Dodick Trabeclectomy Punch Only

Catalog #	Diameter, Deep Bite
OP-395-01	Ø 1.0 mm, 0.5 mm

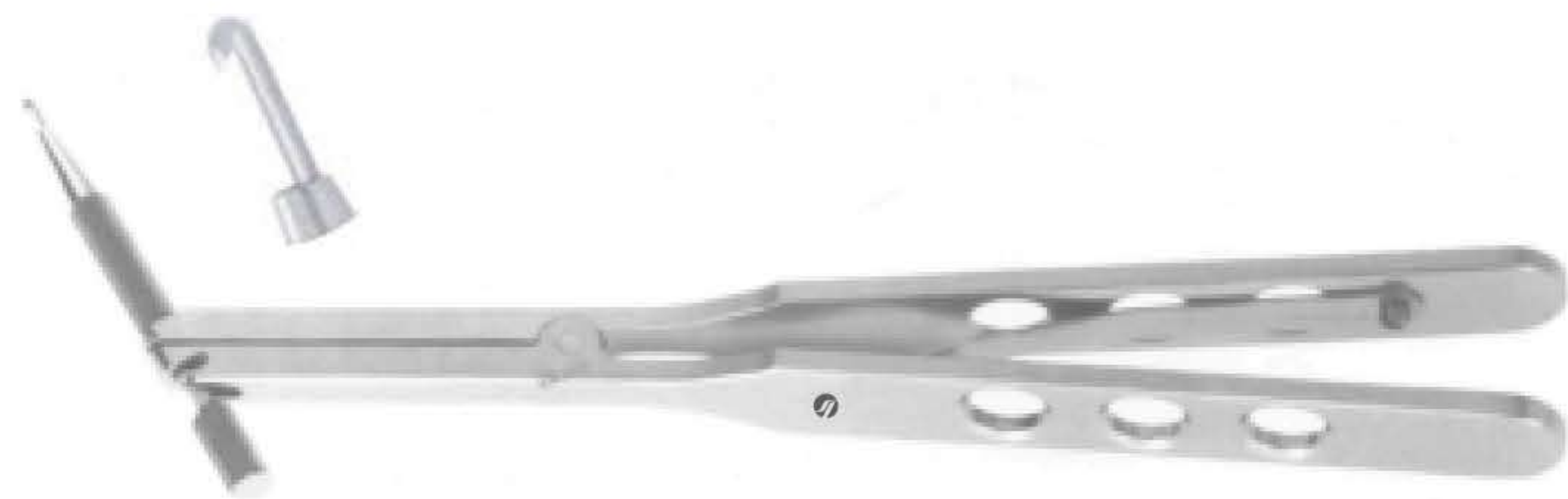

Kelly Descemet's Membrane Punch

Catalog #	Diameter, Deep Bite
OP-397-00	Ø 1.0 mm, 0.5 mm

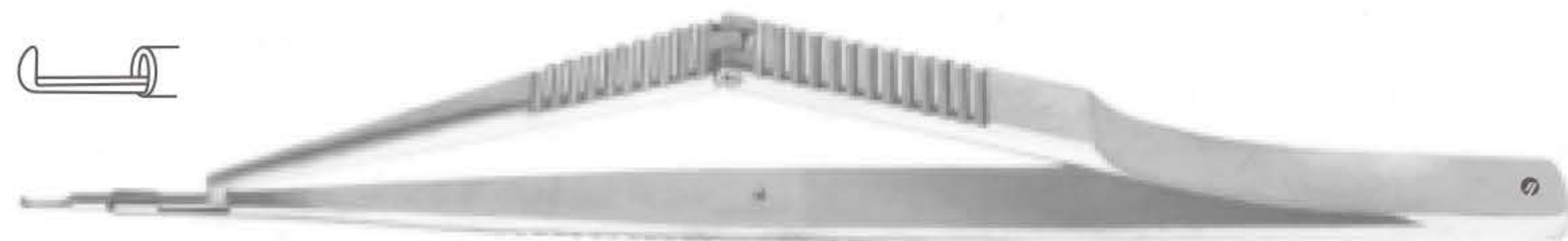

Christensen Punctum Punch
 For Opening Stenotic Punctums

Catalog #	Size, Width
OP-399-00	10 cm (4"), 1.0 mm



Trephines, Cannulas
 Trephinen, Kanülen
 Trépanos, Cánulas
 Trépans, Canules
 Trepani, Cannule

Corneal Trephine Blade

Catalog #	Diameter
OP-400-01	Ø 6.0 mm
OP-400-02	Ø 6.5 mm
OP-400-03	Ø 6.75 mm
OP-400-04	Ø 7.0 mm
OP-400-05	Ø 7.25 mm
OP-400-06	Ø 7.5 mm
OP-400-07	Ø 7.75 mm
OP-400-08	Ø 8.0 mm
OP-400-09	Ø 8.25 mm
OP-400-10	Ø 8.5 mm
OP-400-11	Ø 8.75 mm
OP-400-12	Ø 9.0 mm
OP-400-13	Ø 9.5 mm
OP-400-14	Ø 14.0 mm



Corneal Trephine Handle

Catalog #	Diameter
OP-401-01	Ø 6.0 mm
OP-401-02	Ø 6.5 mm
OP-401-03	Ø 6.75 mm
OP-401-04	Ø 7.0 mm
OP-401-05	Ø 7.25 mm
OP-401-06	Ø 7.5 mm
OP-401-07	Ø 7.75 mm
OP-401-08	Ø 8.0 mm
OP-401-09	Ø 8.25 mm
OP-401-10	Ø 8.5 mm
OP-401-11	Ø 8.75 mm
OP-401-12	Ø 9.0 mm
OP-401-13	Ø 9.5 mm



Cannulas
 Kanülen
 Cánulas
 Canules
 Cannule

Lacrimal Cannula
 Straight



Catalog #	Gauge
OP-410-23	23 G

Lacrimal Cannula
 Curved



Catalog #	Gauge
OP-411-23	23 G

McIntyre Lacrimal Cannula
 Straight



Catalog #	Gauge
OP-412-23	23 G

McIntyre Lacrimal Cannula
 Curved



Catalog #	Gauge
OP-413-23	23 G

West Lacrimal Cannula
 Blunt Tip



Catalog #	Gauge
OP-415-23	23 G

Cannulas
 Kanülen
 Cánulas
 Canules
 Cannule

Air Injection Cannula
 Angled at 5 mm

Catalog #	Gauge
OP-421-27	27 G
OP-421-30	30 G



Air Injection Cannula
 Angled at 7 mm

Catalog #	Gauge
OP-423-27	27 G
OP-423-30	30 G



Randolph Cyclodialysis Cannula
 Flat Tip

Catalog #	Gauge
OP-427-19	19 G
OP-427-21	21 G

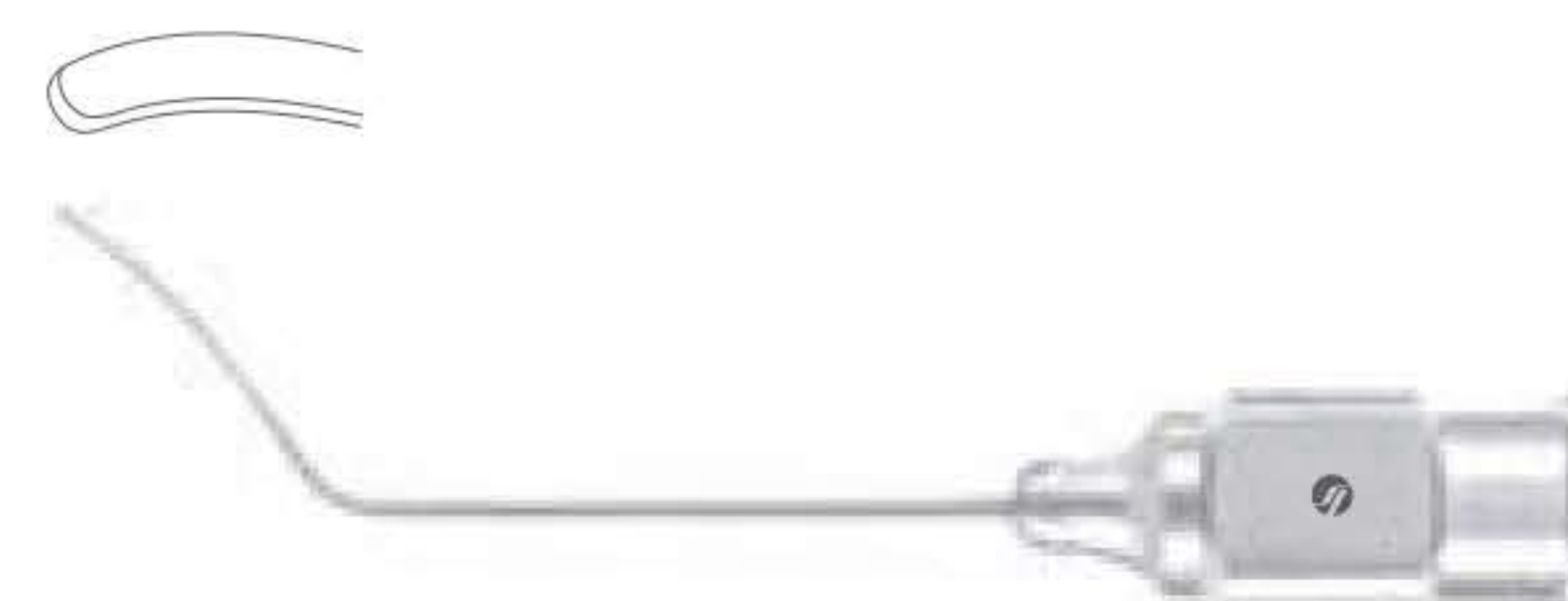

Viscoelastic Aspirating Cannula
 Angled at 10 mm

Catalog #	Gauge
OP-429-19	19 G
OP-429-22	22 G



Troutman Olive Tip Cannula
 Delicate

Catalog #	Gauge
OP-433-25	25 G



Cannulas
 Kanülen
 Cánulas
 Canules
 Cannule

Rainin Air Injection Cannula
 Flat Tip, Angled at 7 mm

Catalog #	Gauge
OP-437-27	27 G
OP-437-30	30 G



Lasek Alcohol Cannula
 Delicate Olive Shaped Tip

Catalog #	Gauge
OP-439-25	25 G



Stevens Sub Tenon's Anesthesia Cannula
 Gently Curved, Flat Tip

Catalog #	Gauge
OP-441-19	19 G



Arkinson Retrobulbar Needle

Catalog #	Gauge
OP-443-23	23 G



Corbin Sub Tenon's Anesthesia Cannula
 Smooth Rounded Tip

Catalog #	Gauge
OP-445-23	23 G



Cannulas
 Kanülen
 Cánulas
 Canules
 Cannule

Fukasaku Tenon's Anesthesia Cannula
 Gently Curved, Smooth Tip

Catalog #	Gauge
OP-447-24	24 G

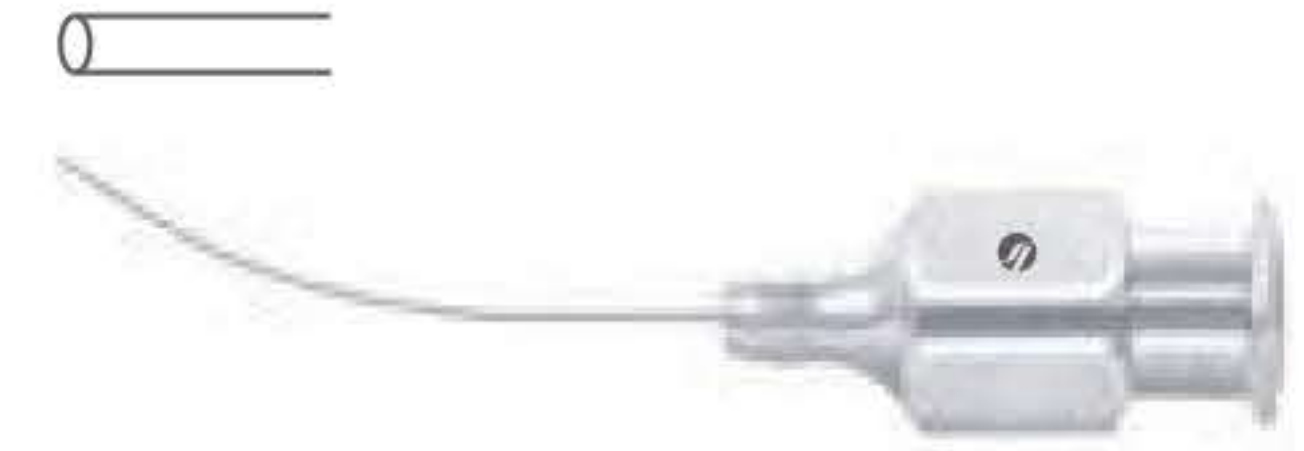

Simcoe (Reversed) Irrigation Aspirating Cannula

Catalog #	Gauge
OP-451-23	23 G

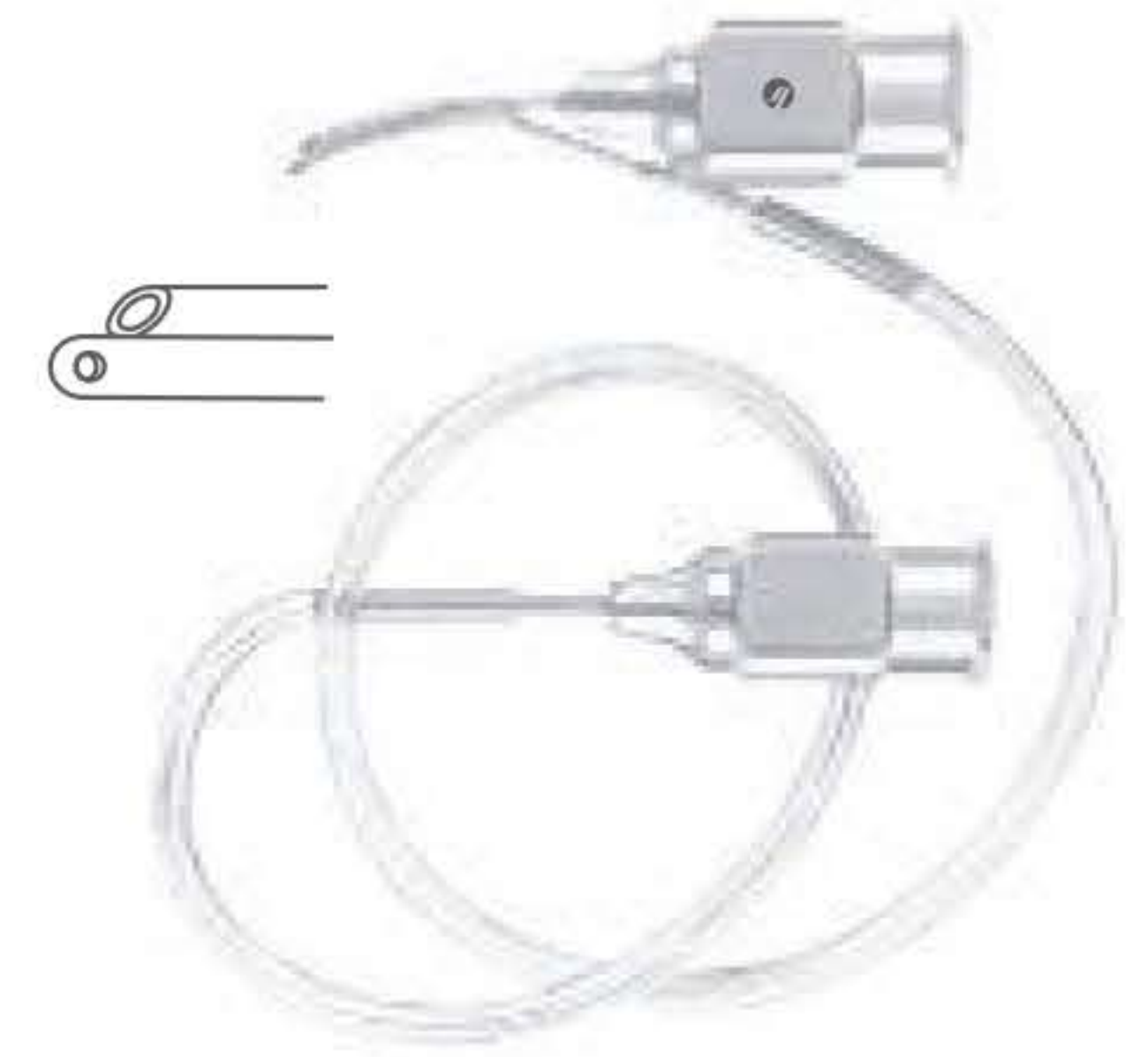

Simcoe (Reversed) Irrigation Aspirating Cannula

Catalog #	Gauge
OP-453-23	23 G

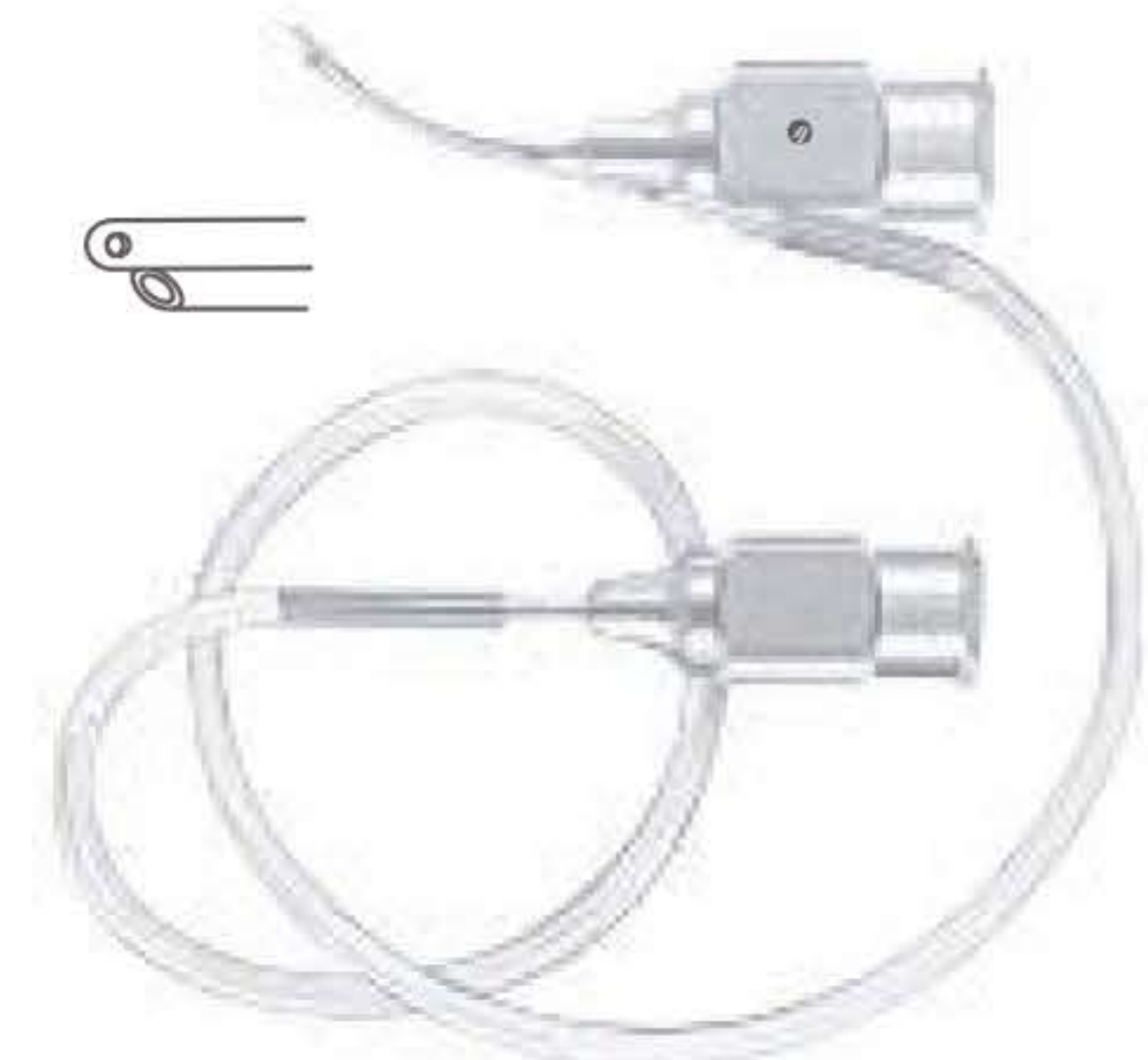

Simcoe Irrigation Aspirating Cannula
 Right

Catalog #	Gauge
OP-455-23	23 G

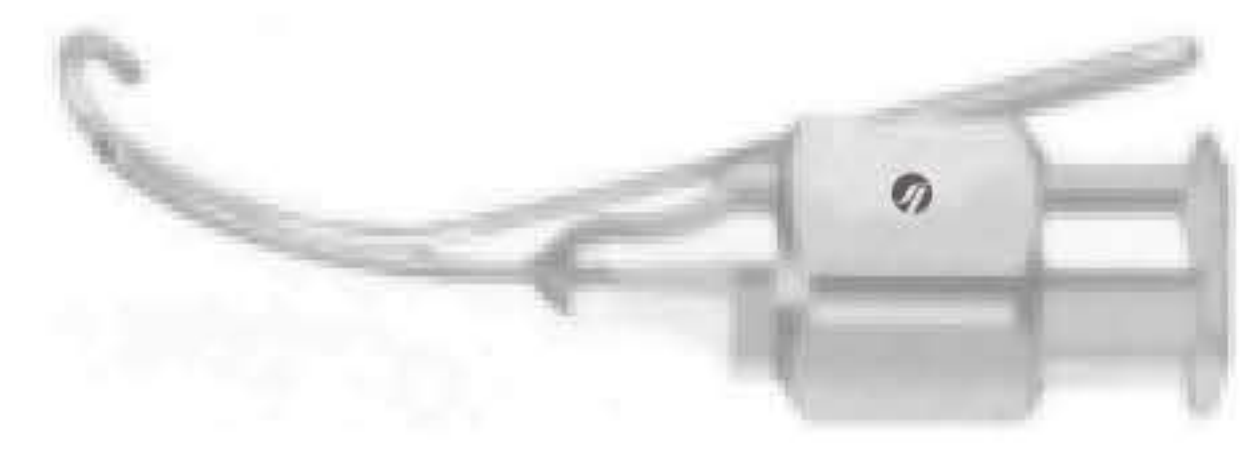

Simcoe Irrigation Aspirating Cannula
 Left

Catalog #	Gauge
OP-457-23	23 G

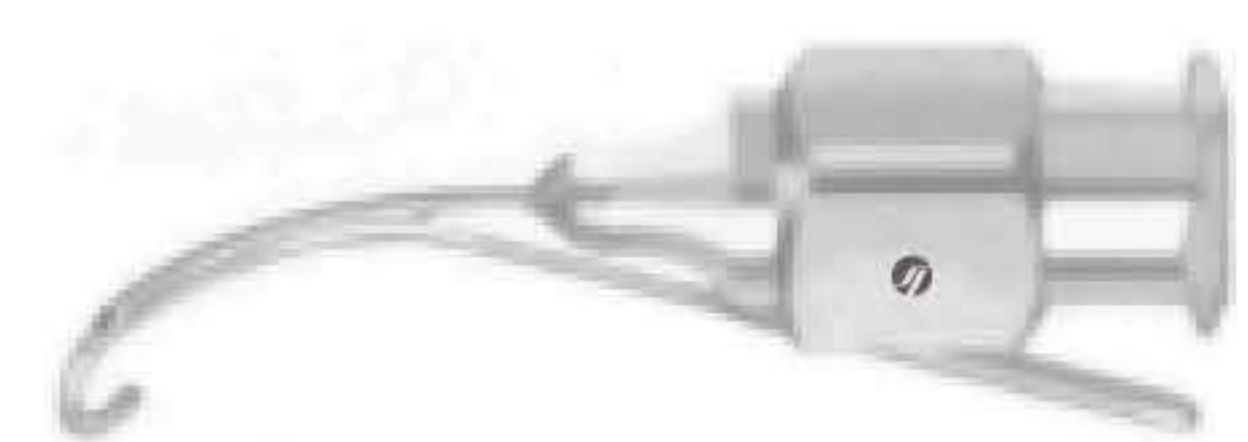

Cannulas
 Kanülen
 Cánulas
 Canules
 Cannule

Gills Irrigation Aspirating Cannula

Catalog #	Gauge
OP-459-23	23 G

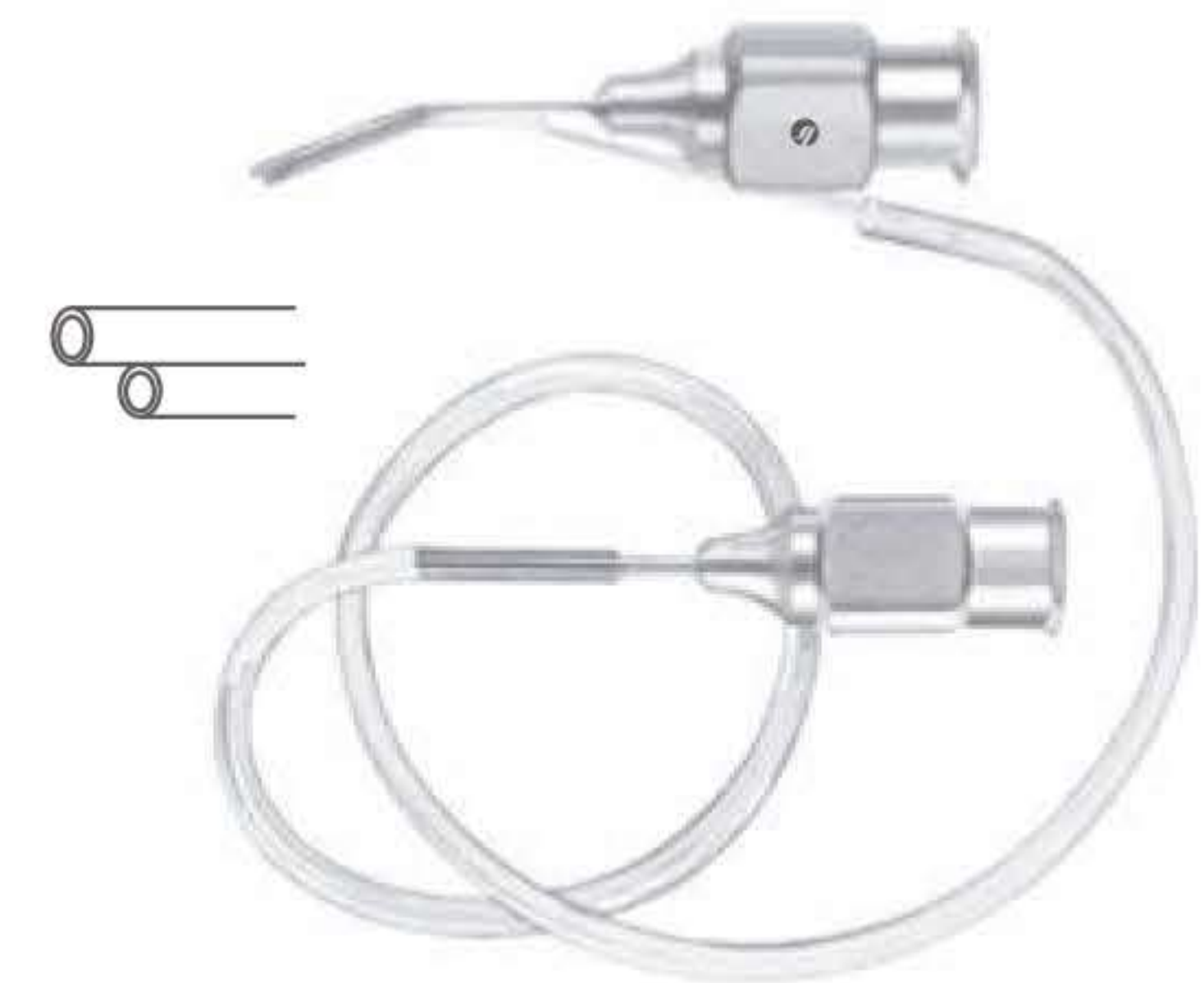

Kelman Cystotome

Catalog #	Gauge
OP-462-22	23 G



Kartz Cystotome

Catalog #	Gauge
OP-463-22	22 G

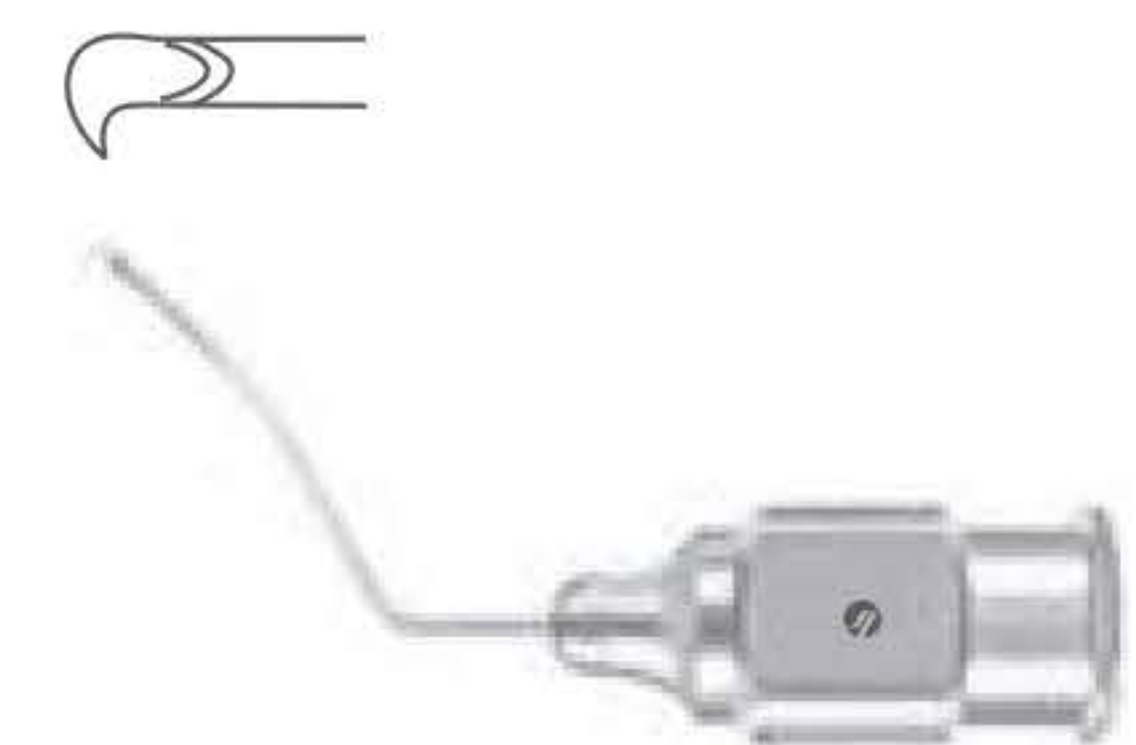

McIntyre Cystotome

Catalog #	Gauge
OP-465-23	23 G

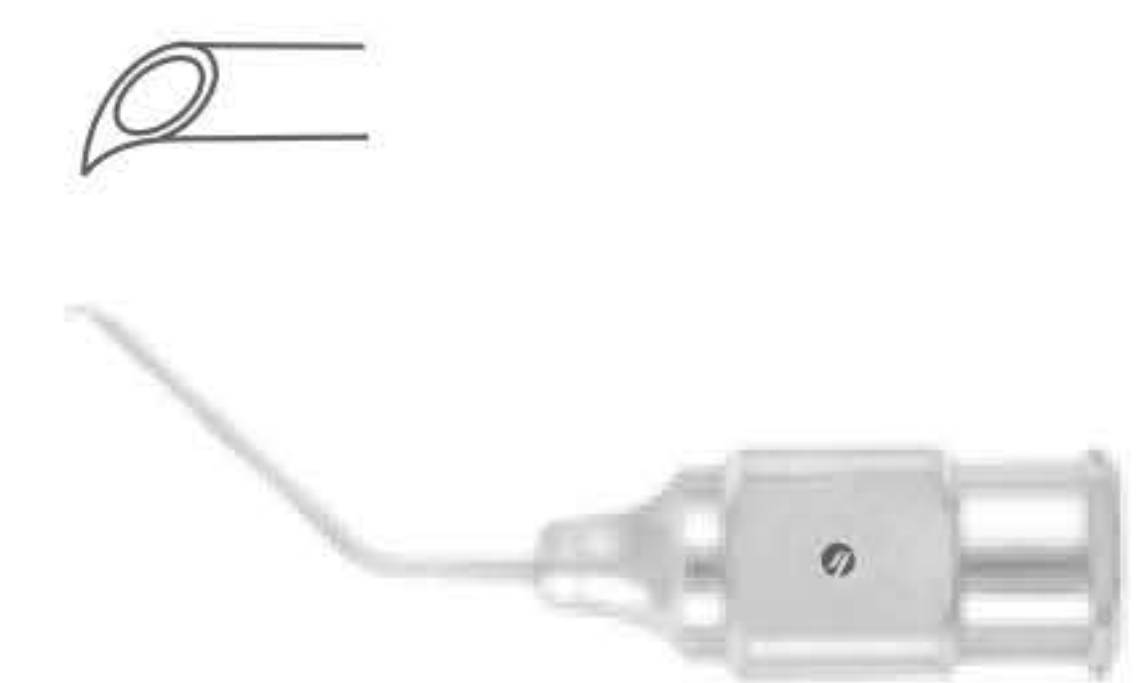

Bishop-Harmon Anterior Chamber Irrigator

Catalog #	Gauge
OP-471-19	19 G



Cannulas
 Kanülen
 Cánulas
 Canules
 Cannule

Hydrodissection Cannula
 Angled at 8 mm, Flat Tip

Catalog #	Gauge
OP-475-25	25 G



Seeley Hydrodissection Cannula
 Angled at 12 mm, Flat Tip

Catalog #	Gauge
OP-477-26	25 G

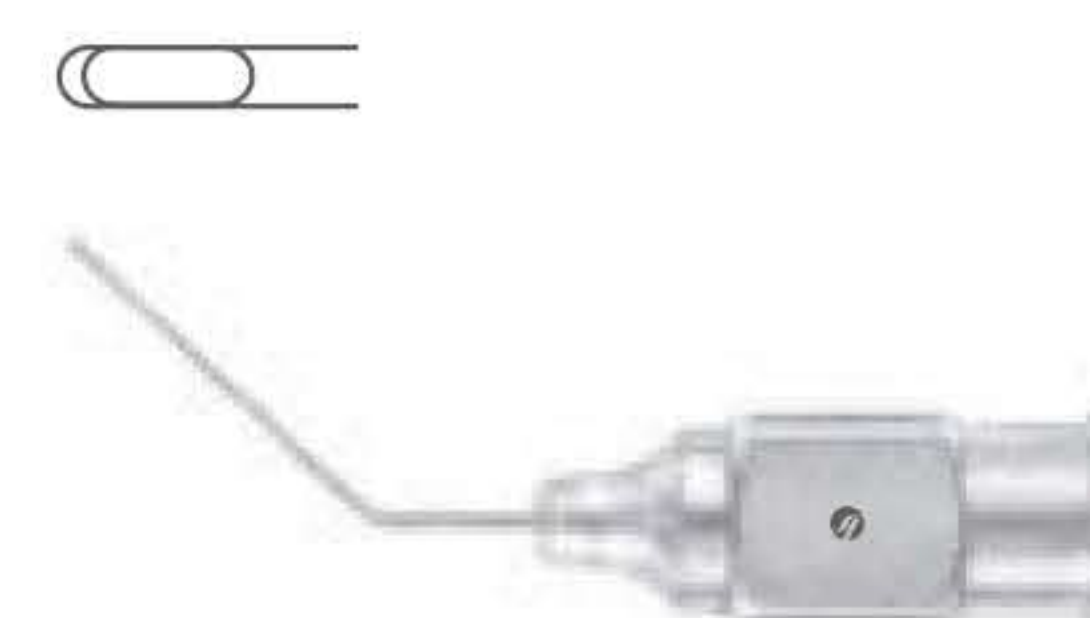

Knolle Anterior Chamber Irrigation Cannula
 Angled at 2 mm

Catalog #	Gauge
OP-481-23	23 G
OP-481-27	27 G
OP-481-30	30 G

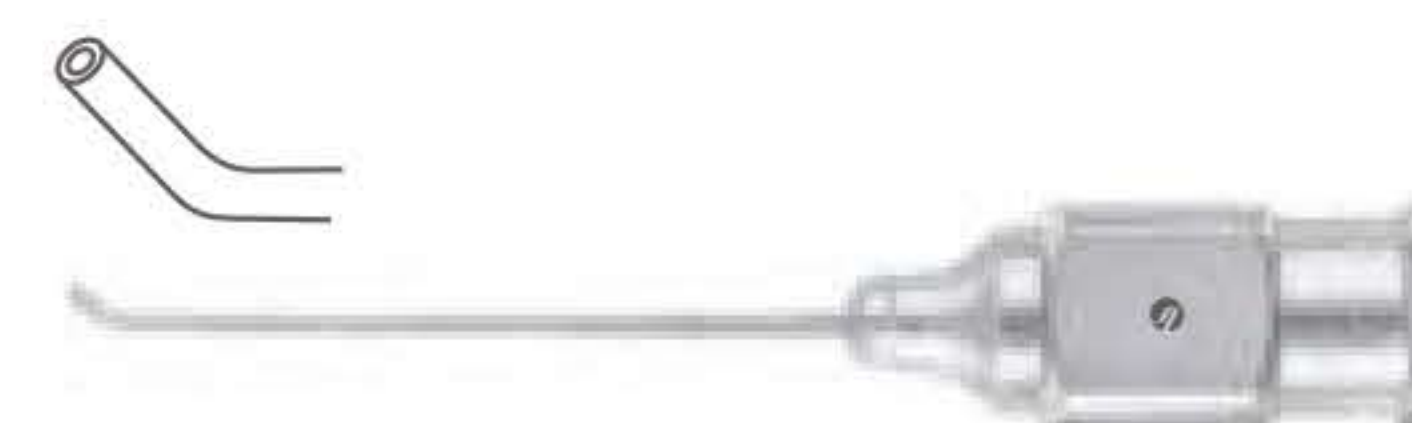

Sauter Hydrodissection Cannula
 Verrically Flattened Tip

Catalog #	Gauge
OP-485-27	27 G



Bracken Irrigation Cannula
 Smooth Beveled Tip

Catalog #	Gauge
OP-487-19	19 G



Cannulas
 Kanülen
 Cánulas
 Canules
 Cannule

Irrigation Cannula
 Thin Wall

Catalog #	Gauge
OP-489-23	23 G

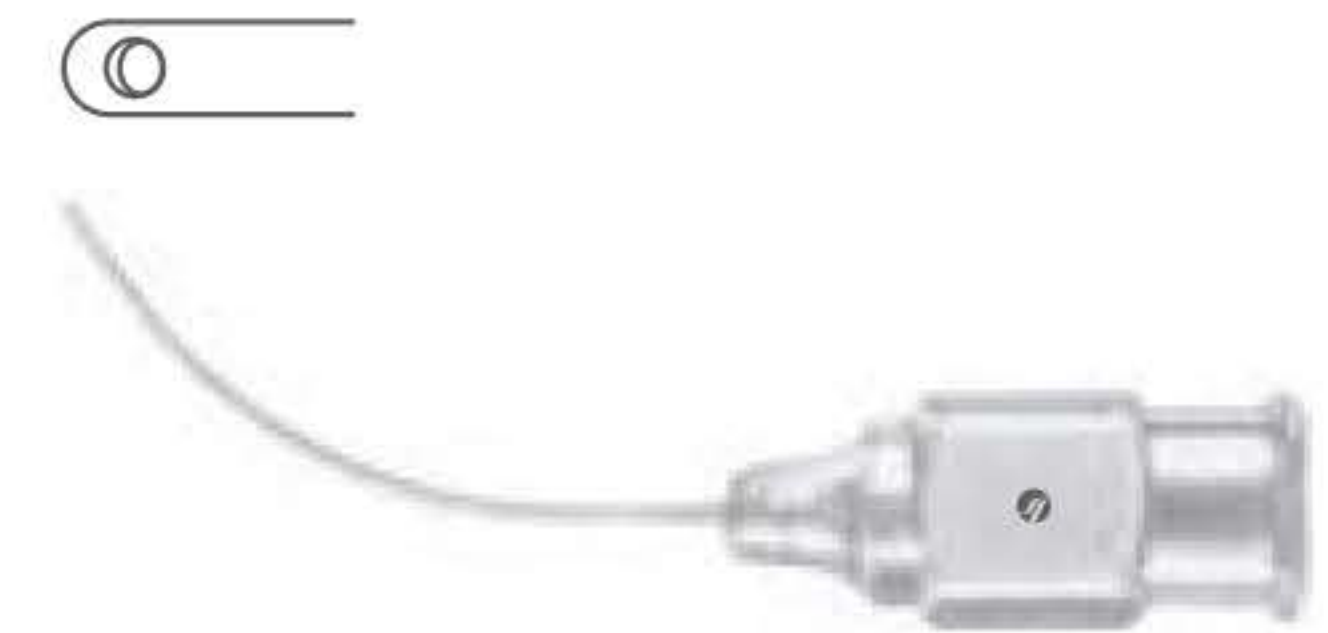

Alio Lasik Irrigation Cannula
 With One Front and Two Side Ports

Catalog #	Gauge
OP-491-23	23 G

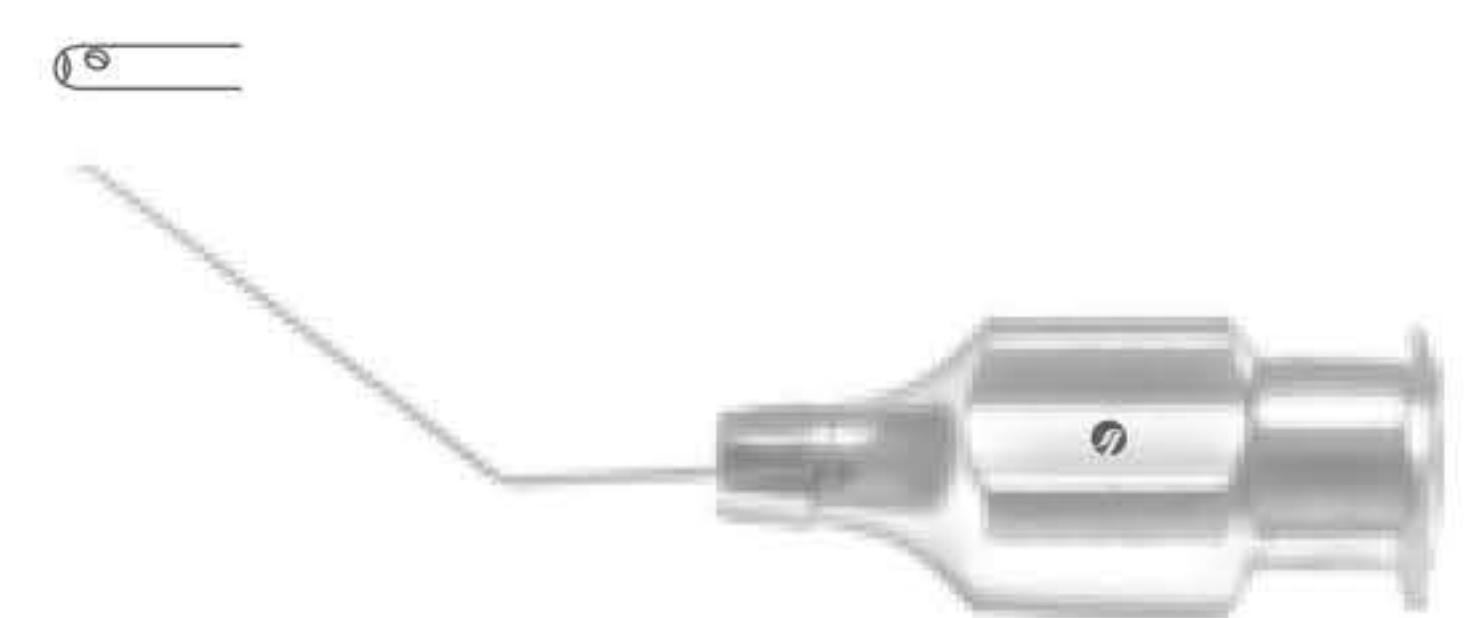

Irrigation Cannula

Catalog #	Gauge
OP-493-21	21 G

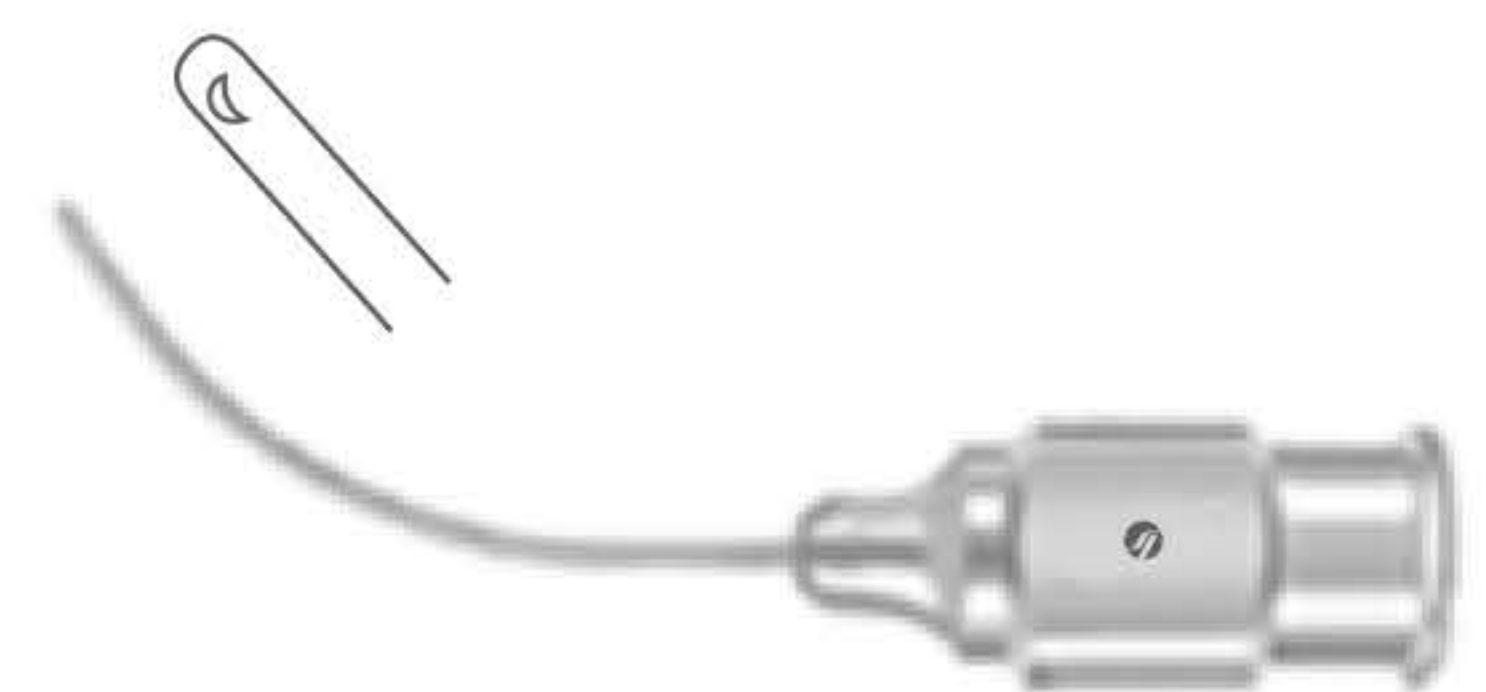

Spatulated Lasik Cannula
 Flattened Spatulated Tip, End Opening

Catalog #	Gauge
OP-495-26	26 G



Fukasaku Lasik Cannula
 Low Profile Tip, End Opening

Catalog #	Gauge
OP-501-23	23 G

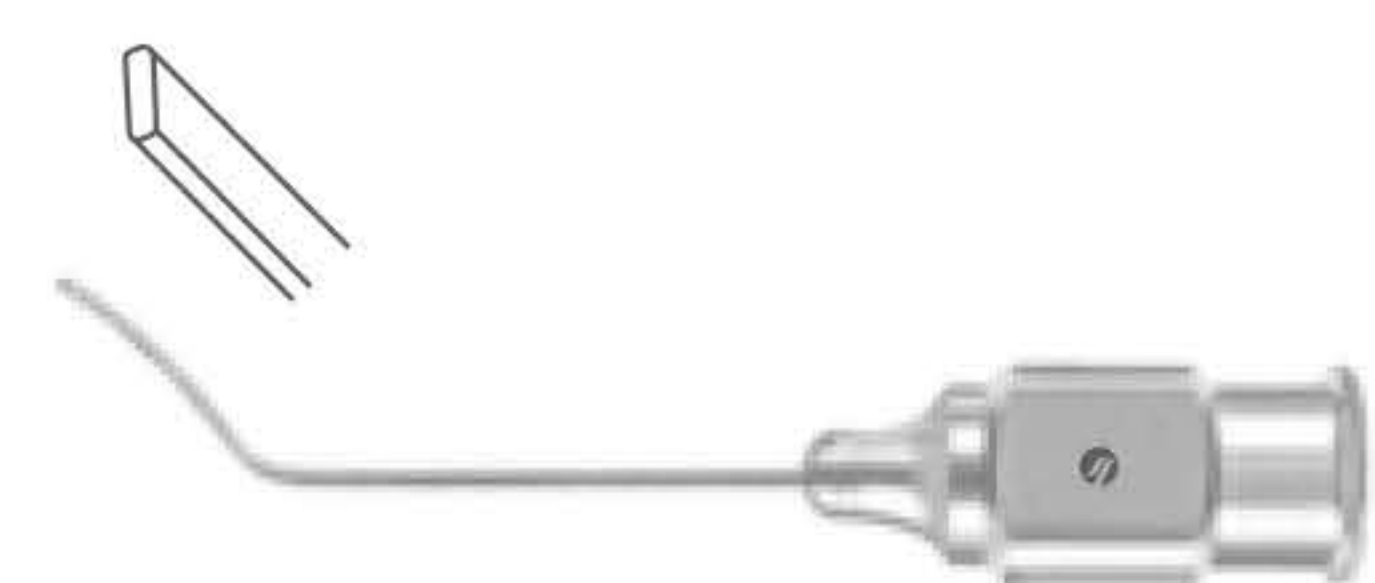

Cannulas
 Kanülen
 Cánulas
 Canules
 Cannule

Carter Lasik Cannula
 Flattened Tip, End Opening

Catalog #	Gauge
OP-503-25	25 G



Banaji Lasik Cannula
 With 6 Ports

Catalog #	Gauge
OP-507-25	25 G

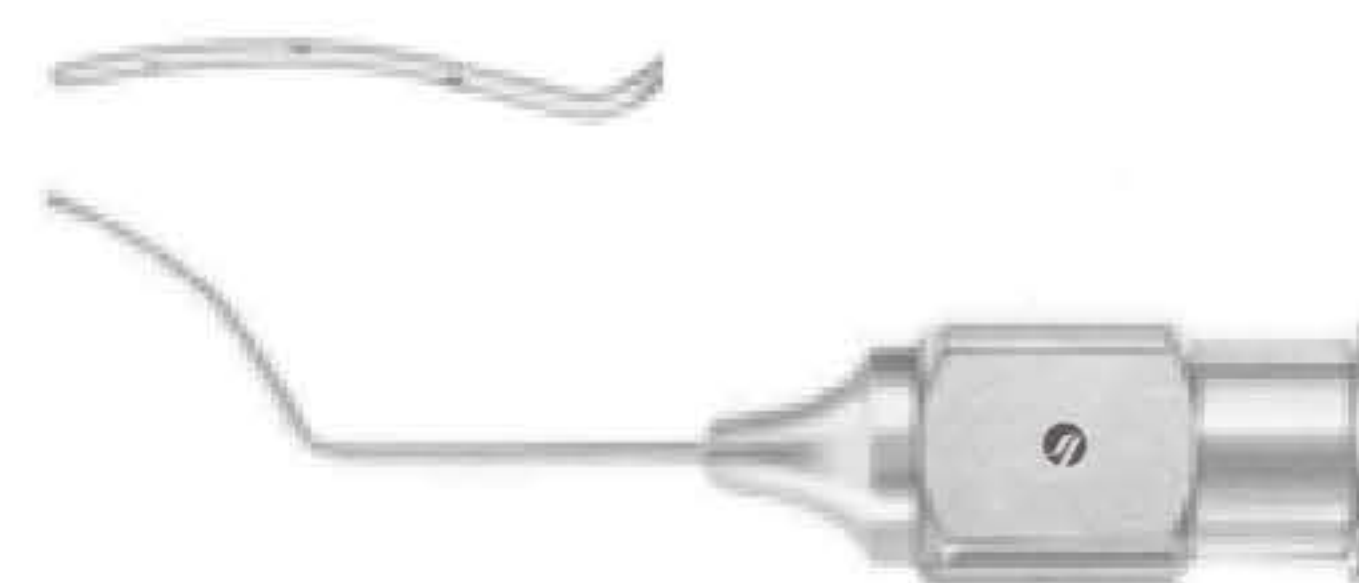

Buratto Lasik Cannula
 With 3 Ports , Slightly Flattened

Catalog #	Gauge
OP-509-23	23 G
OP-509-25	25 G

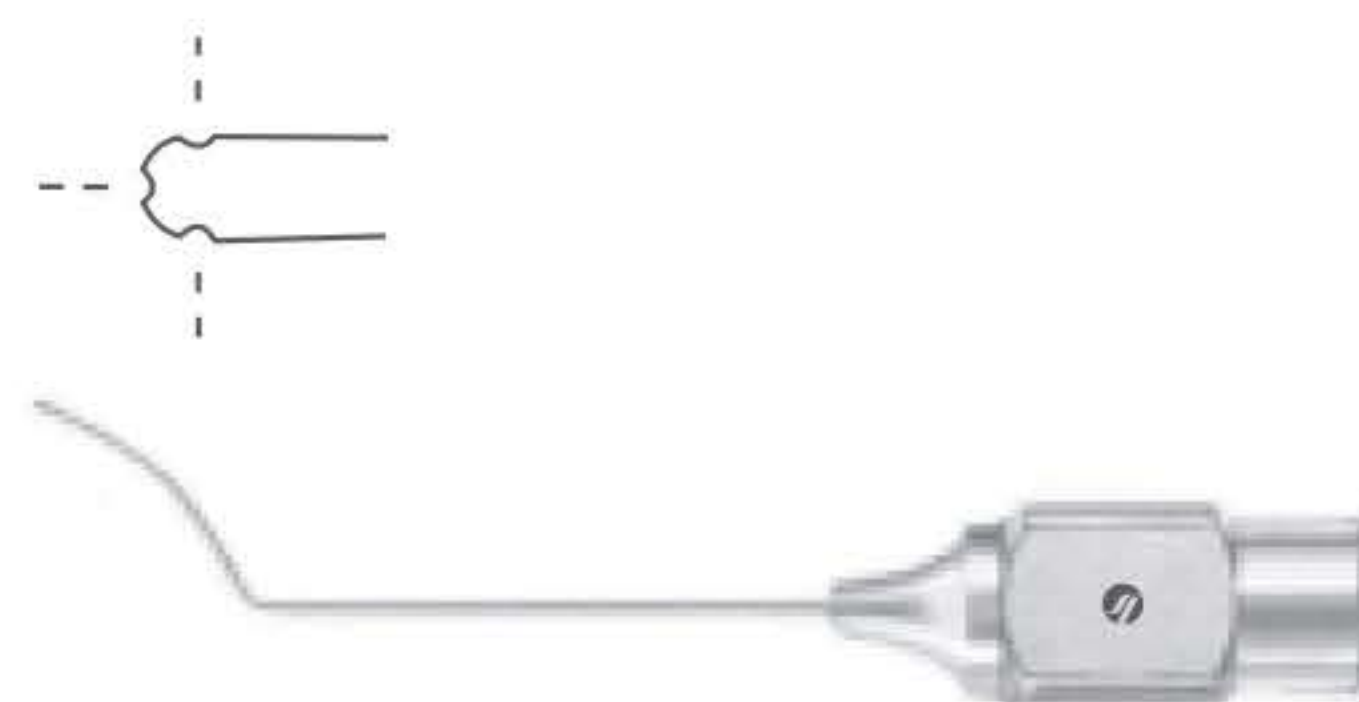

Brierley Lasik Cannula
 With 6 Ports , Spatulated Flattened

Catalog #	Gauge
OP-511-25	25 G

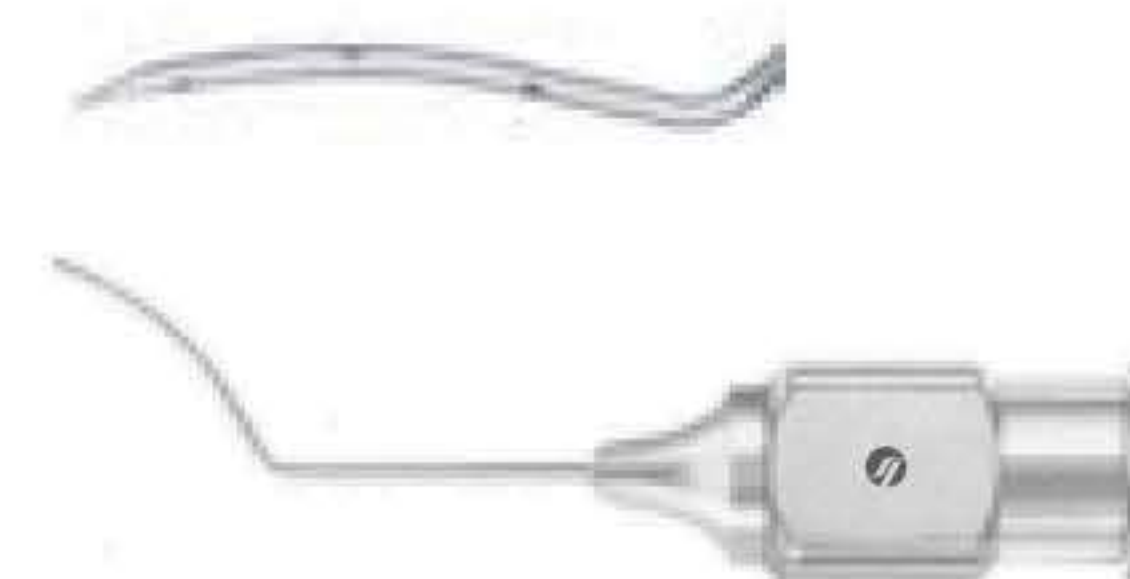

McIntyre Anterior Chamber Cannula
 Straight

Catalog #	Gauge
OP-516-23	23 G
OP-516-26	26 G
OP-516-30	30 G



Cannulas
 Kanülen
 Cánulas
 Canules
 Cannule

McIntyre Anterior Chamber Cannula
 Angled

Catalog #	Gauge
OP-517-23	23 G
OP-517-26	26 G
OP-517-30	30 G

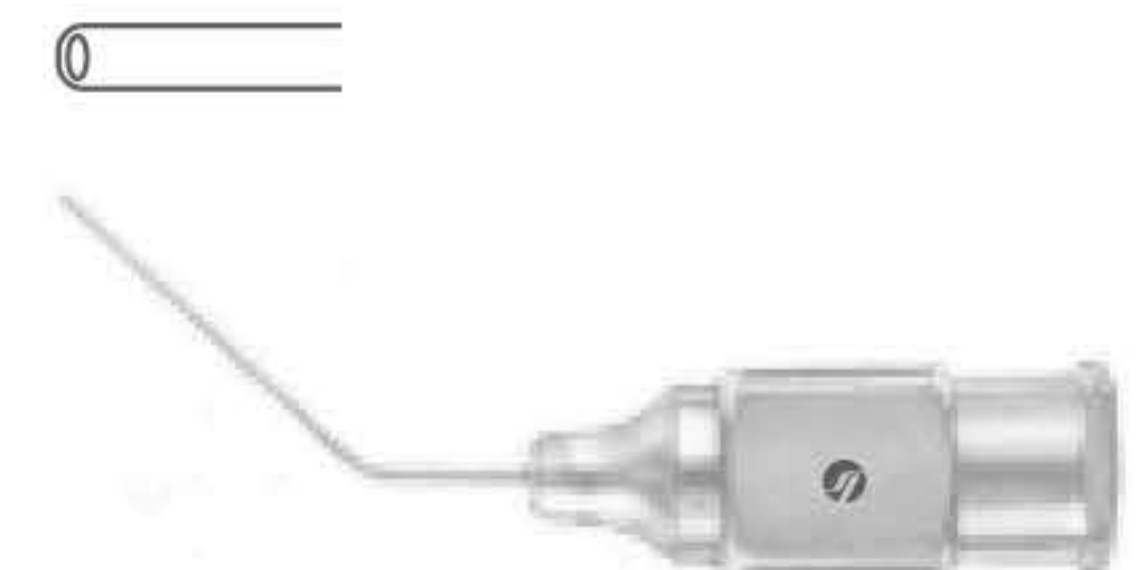

Gimbel Cortex Aspirating Cannula
 End Opening

Catalog #	Gauge
OP-519-30	30 G

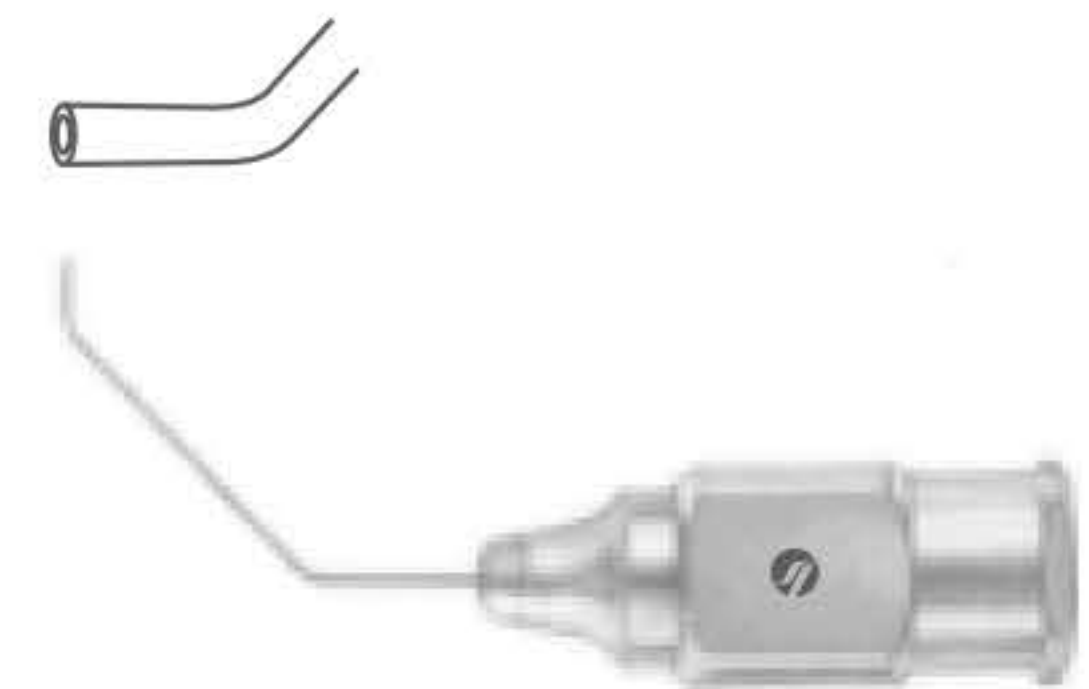

Simcoe Cortex Extractor
 Smooth Tip, 13 mm Long

Catalog #	Gauge
OP-521-23	23 G

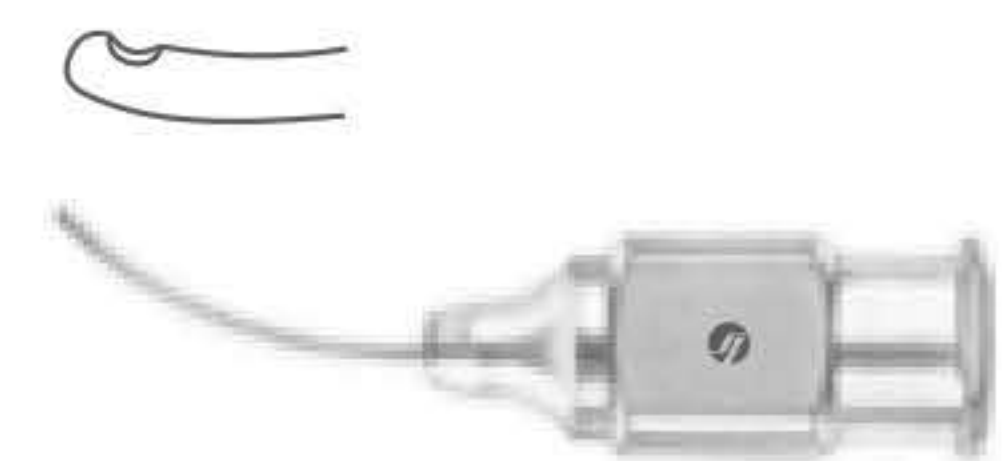

Simcoe Cortex Extractor
 Smooth Tip, 21 mm Long

Catalog #	Gauge
OP-523-23	23 G

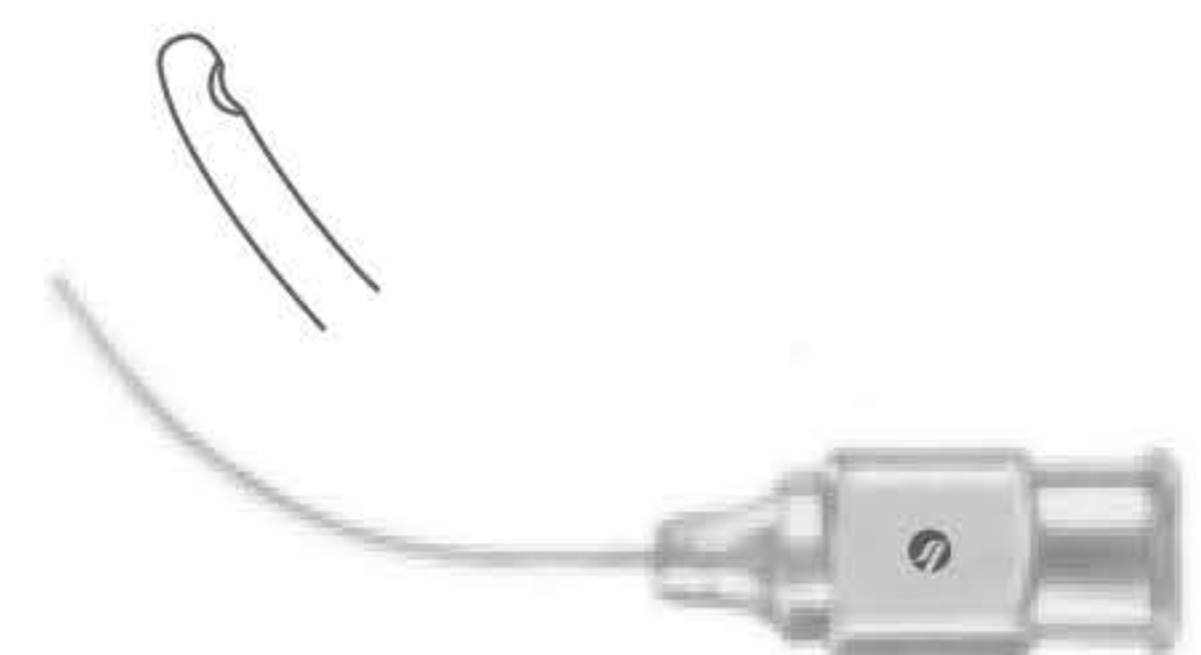

Simcoe Cortex Extractor
 Smooth Closed Tip, 21 mm Long

Catalog #	Gauge
OP-525-21	21 G

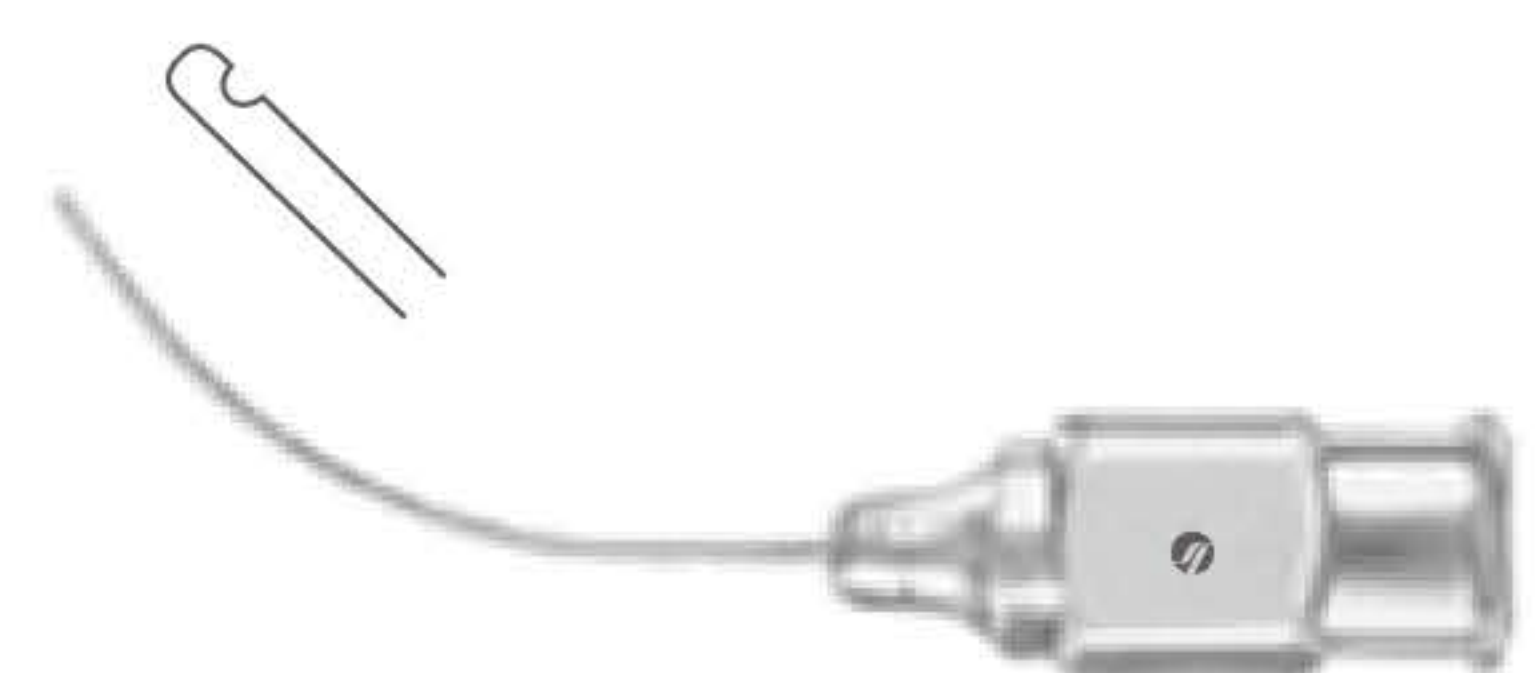

Cannulas
 Kanülen
 Cánulas
 Canules
 Cannule

Gills Aspirating Cannula

Catalog #	Gauge, Tip Size
OP-529-05	25 G, 5 mm
OP-529-07	25 G, 7 mm
OP-529-08	25 G, 8 mm
OP-529-10	25 G, 10 mm



Fukasaku HydroChop Cannula
 Vertically Flattened Tip, Dual Side Ports

Catalog #	Gauge
OP-531-23	23 G



Drews Irrigation Vectis

Catalog #	Gauge
OP-533-23	23 G



Sheets Irrigation Vectis

Catalog #	Gauge
OP-535-20	20 G

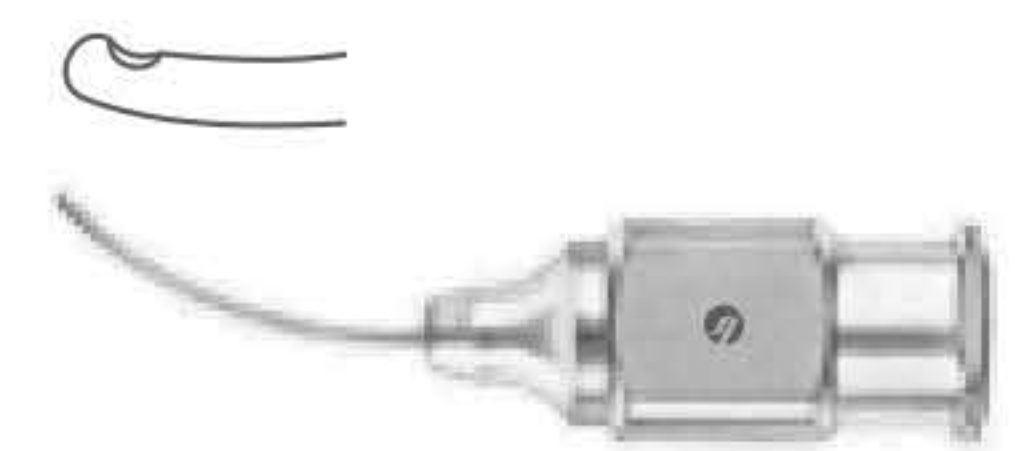

Knolle-Pearce Irrigation Vectis

Catalog #	Gauge
OP-537-23	23 G



Cannulas, Chalazion Curette
 Kanülen, Chalazionslöffel
 Cánulas, Cucharillas para Chalazión
 Canules, Cuillers à chalazion
 Cannule, Cucchiari per calazio

Simcoe Irrigation Lens Nucleus Loop
 Right

Catalog #	Gauge
OP-539-25	25 G

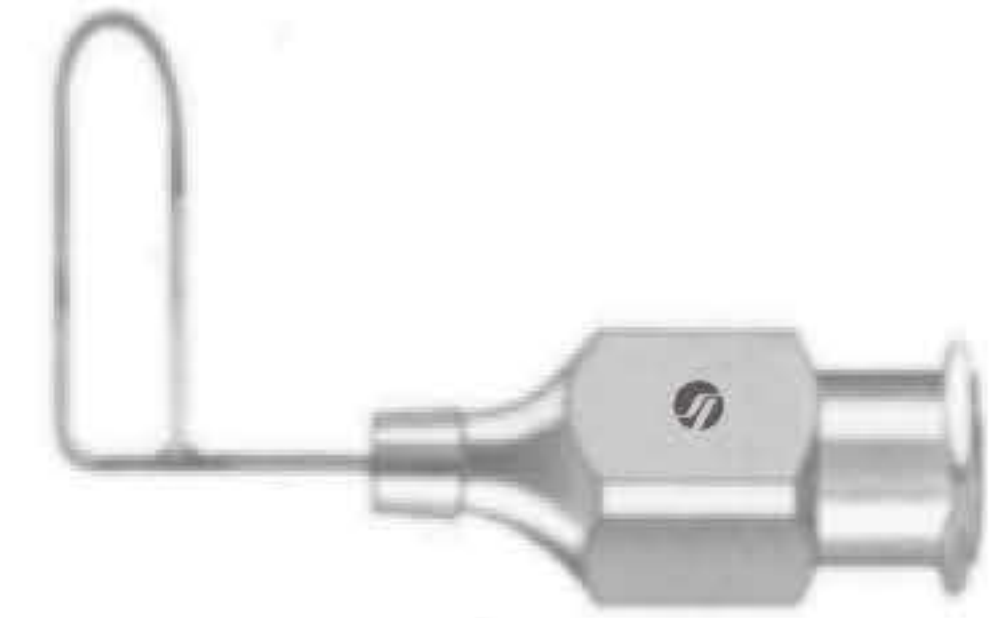

Simcoe Irrigation Lens Nucleus Loop
 Left

Catalog #	Gauge
OP-541-25	25 G

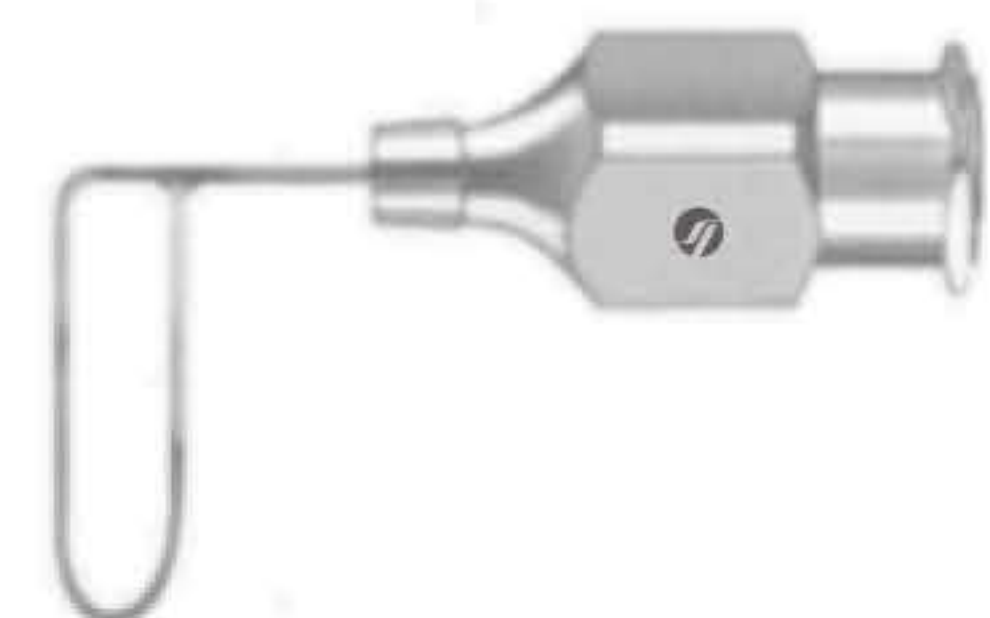

Drof Infusion Cannula
 3 mm Long Tip

Catalog #	Gauge 1, Gauge 2
OP-543-22	18 G, 22 G



Heslin Infusion Cannula
 Textured Tip

Catalog #	Gauge
OP-545-23	23 G
OP-545-25	25 G



Infusion Cannula
 Self Retaining Tip

Catalog #	Gauge
OP-547-22	22 G

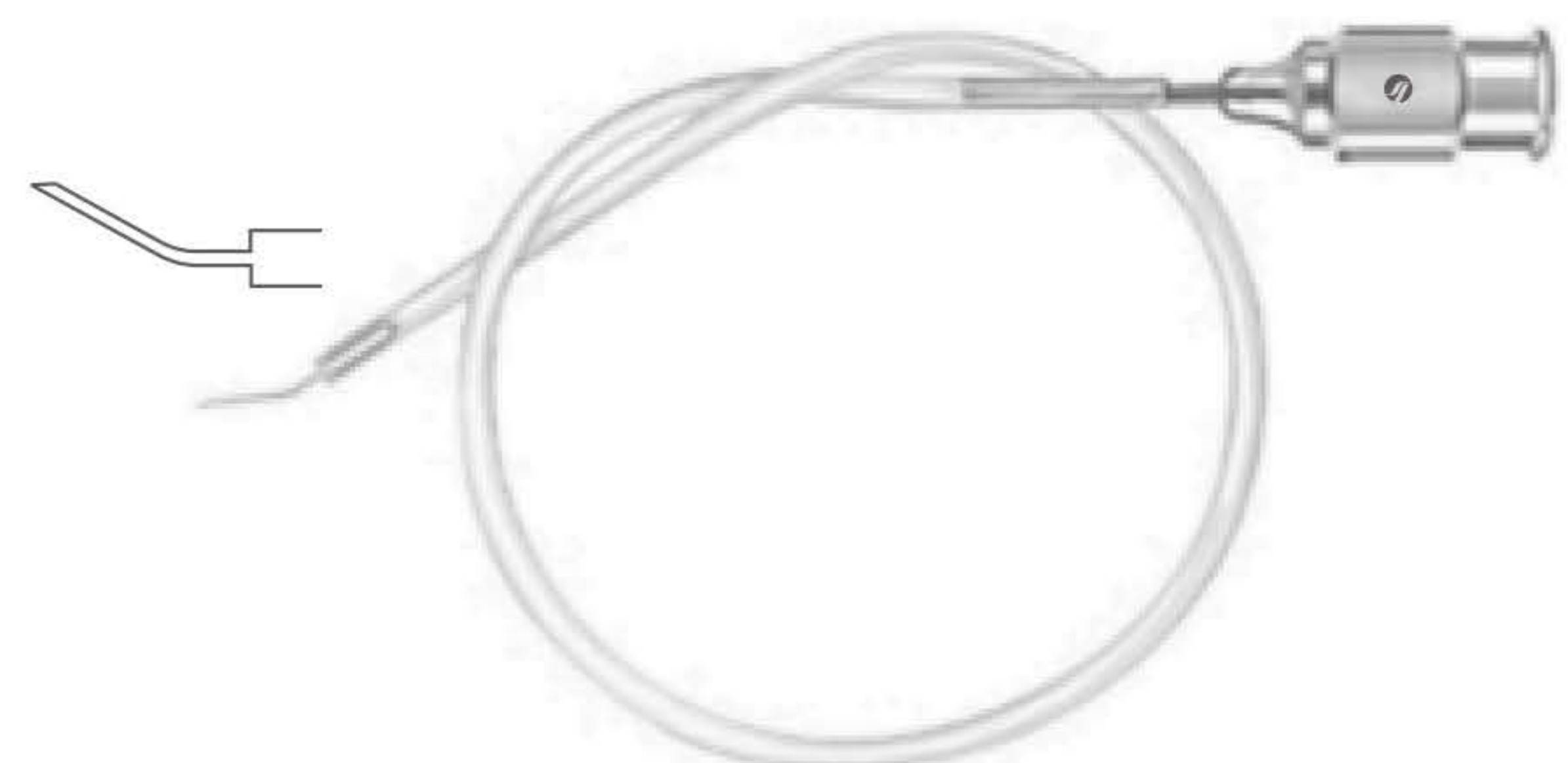

Ophthalmology Instruments
 Ophthalmologie Instrumente
 Oftalmologia Instrumentos
 Ophtalmologie Instruments
 Oftalmologia Strumenti

Meyerhoefer Chalazion Curette

Catalog #	Size, Diameter, Profile
OP-550-00	12.5 cm (5"), Ø 1.75 mm, Size 0
OP-550-01	12.5 cm (5"), Ø 1.2 mm, Size 1
OP-550-02	12.5 cm (5"), Ø 2.25 mm, Size 2
OP-550-03	12.5 cm (5"), Ø 2.5 mm, Size 3
OP-550-04	12.5 cm (5"), Ø 3.5 mm, Size 4

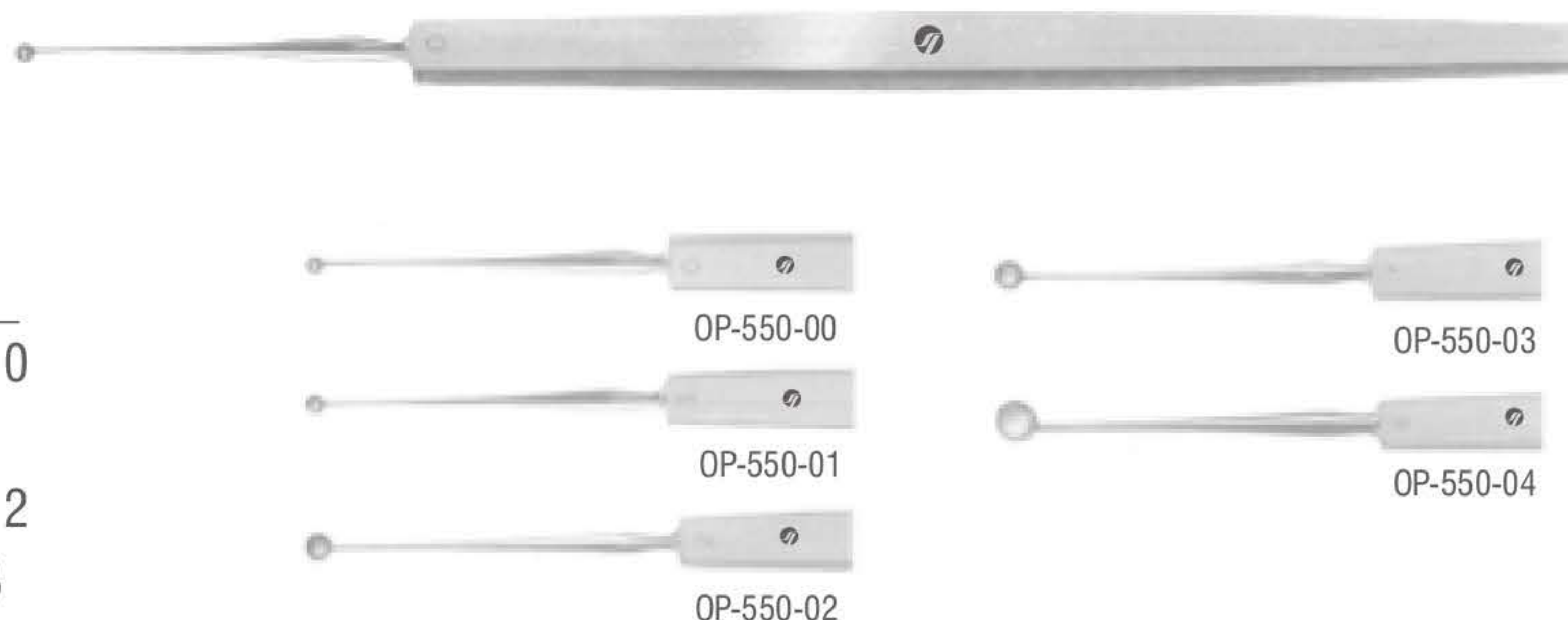

Nightingale Posterior Capsule

Polishing Curette, With Semi Sharp Edge

Catalog #	Size, Diameter
OP-571-12	12.5 cm (5"), Ø 1.75 mm



Shephard Capsule Polishing Curette

Open Ring Semi Sharp Edges on Top and Bottom

Catalog #	Size, Diameter
OP-573-12	12.5 cm (5"), Ø 1.75 mm



Blumenthal Conjunctiva Dissector

With Blunt Disc Shaped Tip

Catalog #	Size
OP-587-13	13 cm (5")



Burattor Lasik Flap Protector



Catalog #	Size
OP-591-12	12.5 cm (5")

Burattor Lasik Flap Protector
 Blades Angled 15°



Catalog #	Size
OP-594-11	11.5 cm (4 1/2")

Mannis-Buratto Lasik Flap Protector
 Blades Angled 45°



Catalog #	Size
OP-597-11	11.5 cm (4 1/2")

Rowen Combination Lasik Flap
 Protector and Spatula



Catalog #	Size
OP-599-13	13 cm (5")

Sloane Lasik Micro Hoe
 Semi-Circular Tip With Beveled Edges



Catalog #	Size
OP-611-12	12 cm (4 3/4")

Ophthalmology Instruments
 Ophthalmologie Instrumente
 Oftalmología Instrumentos
 Ophtalmologie Instruments
 Oftalmologia Strumenti

Sloane Epi Peeler
 Semi-Sharp Edges



Catalog #	Size
OP-615-11	11.5 cm (4 1/2")

Sloane Lasik Micro Hoe & Epi Peeler



Catalog #	Size
OP-619-13	13.5 cm (5 1/4")

Sloane Lasik Epi-Dissector
 Spatulated Tip With Semi-Sharp Edges



Catalog #	Size
OP-623-11	11.5 cm (4 1/2")

Sloane Lasik Flap Reposer
 Gently Curved Spatulated Tip



Catalog #	Size
OP-627-12	12 cm (4 3/4")

Culler Iris Spatula



Catalog #	Size, Width
OP-630-01	13 cm (5"), 1 mm
OP-630-02	13 cm (5"), 2 mm

Ophthalmology Instruments
 Ophthalmologie Instrumente
 Oftalmología Instrumentos
 Ophthalmologie Instruments
 Oftalmologia Strumenti

Wheeler Double-End Spatula
 Lightly Curved



Catalog #	Size
OP-632-13	13 cm (5")

Barraquer Iris Spatula
 Round , Smooth



Catalog #	Size
OP-635-01	12 cm (4 3/4"), 0.25 mm
OP-635-02	12 cm (4 3/4"), 0.5 mm

Gimbel Nucleus Spatula
 Round , Smooth, Angled 30°



Catalog #	Size, Tip Length, Tip Diameter
OP-637-12	12.5 cm (5"), 10 mm, Ø 0.25 mm

Escaf Nucleus Manipulator
 Angled 45°



Catalog #	Size, Tip Length
OP-639-12	12 cm (4 3/4"), 13 mm

Knolle Nucleus Spatula
 Malleable Flat, Stainless Steel



Catalog #	Size, Width
OP-640-12	12.5 cm (5"), 0.5 mm

Ophthalmology Instruments
 Ophthalmologie Instrumente
 Oftalmología Instrumentos
 Ophtalmologie Instruments
 Oftalmologia Strumenti

Koch Nucleus Spatula
 Smooth



Catalog #	Size
OP-643-01	11.5 cm (4 1/2")

Koch Nucleus Spatula
 With Notches



Catalog #	Size
OP-643-02	11.5 cm (4 1/2")

Akahoshi Nucleus Sustainer

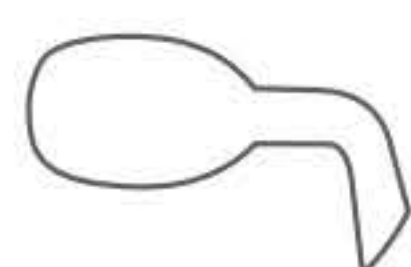

Catalog #	Size
OP-645-11	11.5 cm (4 1/2")

Escaf Nucleus Sustainer
 Smooth Ball Tip, Texture interior Surface



Catalog #	Size
OP-647-12	12 cm (4 3/4")

Lieberman Nucleus Manipulator

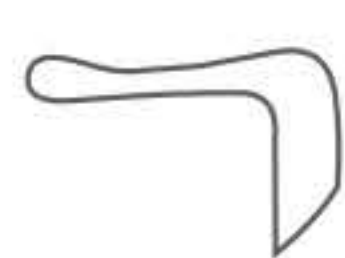

Catalog #	Size, Profile
OP-649-01	12 cm (4 3/4"), Right Hand
OP-649-02	12 cm (4 3/4"), Left Hand

Lieberman Nucleus Manipulator and Spatula

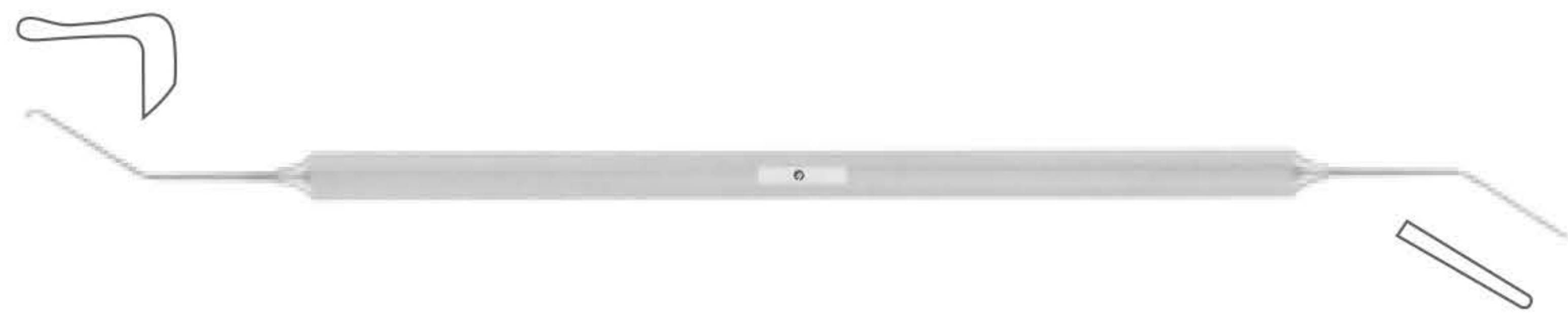

Catalog #	Size, Profile
OP-651-01	14 cm (5 1/2"), Right Hand
OP-651-02	14 cm (5 1/2"), Left Hand

Fukasaku-Lieberman Nucleus Manipulator and Hook



Catalog #	Size, Profile
OP-653-01	13.5 cm (5 1/4"), Right Hand
OP-653-02	13.5 cm (5 1/4"), Left Hand

Masket Phaco Spatula

Round Spatula With Disc Shaped Tip



Catalog #	Size, Spatula Length
OP-657-13	13 cm (5"), 12 mm

Chang Phaco Chopper

Right Hand



Catalog #	Size, Tip Length, Profile
OP-659-01	13 cm (5"), 0.9 mm, Right Hand
OP-659-02	13 cm (5"), 0.9 mm, Left Hand

Minardi Phaco Chopper



Catalog #	Size, Tip Length
OP-661-11	11.5 cm (4 1/2"), 0.7 mm

Ophthalmology Instruments
 Ophthalmologie Instrumente
 Oftalmología Instrumentos
 Ophtalmologie Instruments
 Oftalmologia Strumenti

Hwang Phaco Chopper

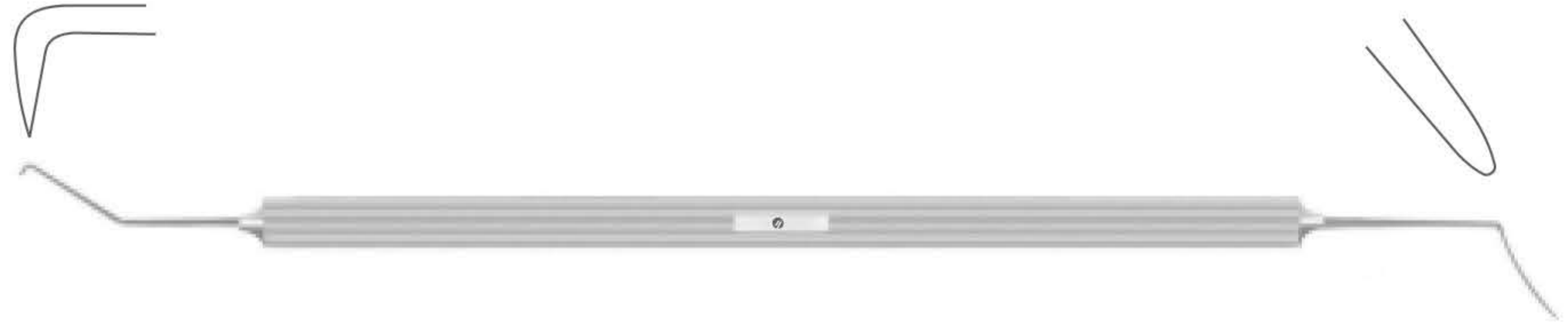

Catalog #	Size
OP-663-13	13.5 cm (5 1/4")

Agarwal Karate Phaco Chopper



Catalog #	Size
OP-665-11	11.5 cm (4 1/2")

Chang Micro Finger Chopper



Catalog #	Size
OP-667-11	11.5 cm (4 1/2")

Brierley Nucleus Splitter



Catalog #	Size
OP-669-12	12 cm (4 3/4")

Dodick-Kammann Nucleus Chopper
 Straight



Catalog #	Size, Tip Length
OP-670-15	12 cm (4 3/4"), 1.5 mm
OP-670-20	12 cm (4 3/4"), 2.0 mm

Dodick-Kammann Nucleus Chopper
 Angled

Catalog #	Size, Tip Length
OP-671-15	12 cm (4 3/4"), 1.5 mm
OP-671-20	12 cm (4 3/4"), 2.0 mm



Ecsaf Nucleus Divdider
 Wedge Shaped

Catalog #	Size, Tip Length
OP-673-12	12 cm (4 3/4"), 1.25 mm



Neuhann Nucleus Divdider
 Strongly Curved

Catalog #	Size,
OP-675-12	12 cm (4 3/4")



Nagahara Nucleus Spatula
 With Flat Interior Edge

Catalog #	Size,
OP-677-11	11 cm (4 1/4")



Fakasaku Snapper Hook
 Wedge Shaped

Catalog #	Size,
OP-679-11	11.5 cm (4 1/2")



Ophthalmology Instruments
 Ophthalmologie Instrumente
 Oftalmología Instrumentos
 Ophtalmologie Instruments
 Oftalmologia Strumenti

Fakasaku Snapper Hook & Small Pupil
 Wedge Shaped



Catalog #	Size
OP-681-11	11.5 cm (4 1/2")

Rosen Phaco Splitter
 Wedge Shaped



Catalog #	Size
OP-683-11	11.5 cm (4 1/2")

Rosen Phaco Splitter
 Angled 60°, Wedge Shaped



Catalog #	Size
OP-685-11	11.5 cm (4 1/2")

Rowen Phaco Spatula



Catalog #	Size
OP-687-13	13 cm (5")

Bechert Nucleus Rotator
 Blunt Forked Tip, Angled at 7 mm



Catalog #	Size
OP-689-01	11.5 cm (4 1/2")

Ophthalmology Instruments
 Ophthalmologie Instrumente
 Oftalmología Instrumentos
 Ophthalmologie Instruments
 Oftalmologia Strumenti

Jeff-Bechert Nucleus Rotator
 Blunt Forked Tip, Angled at 9 mm



Catalog #	Size
OP-689-02	11.5 cm (4 1/2")

Clayman Nucleus Rotator
 With V-Notched Tip

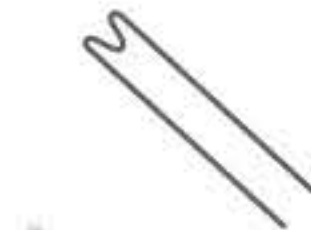

Catalog #	Size
OP-691-11	12 cm (4 3/4")

Drysdale Nucleus Manipulator
 Paddle Shaped Tip



Catalog #	Size
OP-693-11	11 cm (4 1/4")

Pisacano Nucleus Rotator
 Horizontal Flat Disc Shaped Tip



Catalog #	Size
OP-695-11	11.5 cm (4 1/2")

Pisacano Nucleus Rotator
 Vertical Flat Disc Shaped Tip



Catalog #	Size
OP-697-11	11.5 cm (4 1/2")

Ophthalmology Instruments
 Ophthalmologie Instrumente
 Oftalmología Instrumentos
 Ophtalmologie Instruments
 Oftalmologia Strumenti

Siepsner Endocapsular Controller
 Trumpet Shaped Tip



Catalog #	Size
OP-699-11	11.5 cm (4 1/2")

Anis Nucleus Manipulator
 Ball Tip, Straight



Catalog #	Size, Tip Diameter
OP-700-12	12 cm (4 3/4"), Ø 0.5 mm

Anis Nucleus Manipulator
 Ball Tip, Angled



Catalog #	Size, Tip Diameter
OP-701-11	11.5 cm (4 1/2"), Ø 0.5 mm

Tennant Nucleus Rotator
 Ball Shaped Tip



Catalog #	Size, Tip Diameter
OP-703-12	12 cm (4 3/4"), Ø 0.6 mm

Lippman Nucleus Spatula
 Shaft With Blunt Forked Tip



Catalog #	Size, Tip Diameter
OP-705-11	11.5 cm (4 1/2"), Ø 0.5 mm

Ophthalmology Instruments
 Ophthalmologie Instrumente
 Oftalmología Instrumentos
 Ophtalmologie Instruments
 Oftalmologia Strumenti

Girard Synechiaie Spatula
 Semi-Sharp Tip



Catalog #	Size, Tip Diameter
OP-707-11	11.5 cm (4 1/2"), Ø 0.5 mm

Obstbaum Synechiaie Spatula
 Semi-Sharp Tip



Catalog #	Size, Tip Diameter
OP-709-12	12 cm (4 3/4"), Ø 0.25 mm

Moran Lasik Enhancment Spatula



Catalog #	Size
OP-711-13	13.5 cm (5 1/4")

Hersh Flap Spatula



Catalog #	Size
OP-713-14	14 cm (5 1/4")

Binder Flap Elevator



Catalog #	Size
OP-715-13	13 cm (5")

Ophthalmology Instruments
 Ophthalmologie Instrumente
 Oftalmologia Instrumentos
 Ophtalmologie Instruments
 Oftalmologia Strumenti

Fukasaku Lasik Spatula



Catalog #	Size
OP-717-12	12 cm (4 3/4")

Guimaraes Lasik Spatula
 Gently Curved



Catalog #	Size
OP-719-12	12 cm (4 3/4")

Katzen Lasik Flap Unzipper



Catalog #	Size
OP-720-13	13.5 cm (5 1/4")

Maddox Lasik Spatula



Catalog #	Size
OP-723-12	12.5 cm (5")

Lasik Flap Manipulator
 Delicate Olive Tip

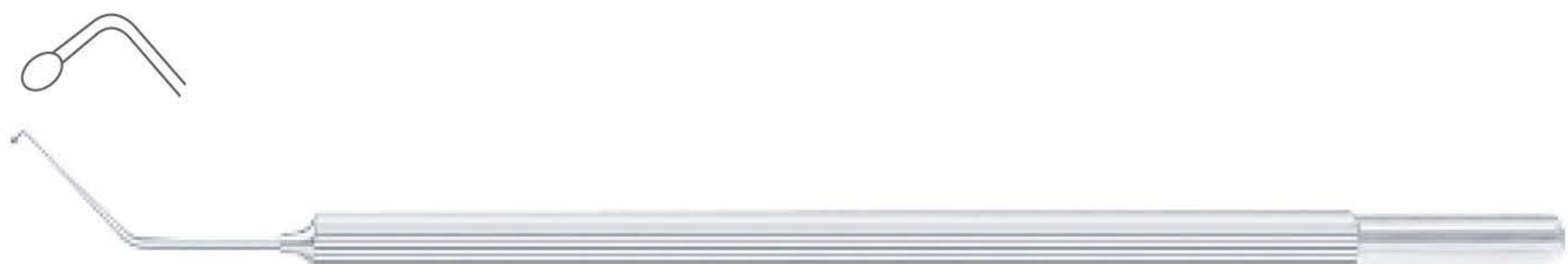

Catalog #	Size
OP-725-11	11.5 cm (4 1/2")

Ophthalmology Instruments
 Ophthalmologie Instrumente
 Oftalmología Instrumentos
 Ophtalmologie Instruments
 Oftalmologia Strumenti

Jaff Lens Spatula
 Flat



Catalog #	Size, Width
OP-727-12	12 cm (4 ¾"), 0.5 mm

Lester IOL Manipulator
 Straight



Catalog #	Size, Tip Diameter
OP-728-12	12 cm (4 ¾"), Ø 0.25 mm

Lester IOL Manipulator
 Angled



Catalog #	Size, Tip Diameter
OP-729-12	12 cm (4 ¾"), Ø 0.25 mm

Lester IOL Manipulator
 Vaulted Shank



Catalog #	Size, Tip Diameter
OP-731-11	11.5 cm (4 ½"), Ø 0.25 mm

Hunkeler IOL Manipulator
 Hemi-Ball Tip



Catalog #	Size, Tip Diameter
OP-733-12	12 cm (4 ¾"), Ø 0.3 mm

Ophthalmology Instruments
 Ophthalmologie Instrumente
 Oftalmología Instrumentos
 Ophtalmologie Instruments
 Oftalmologia Strumenti

Alio-Kelman IOL Hook

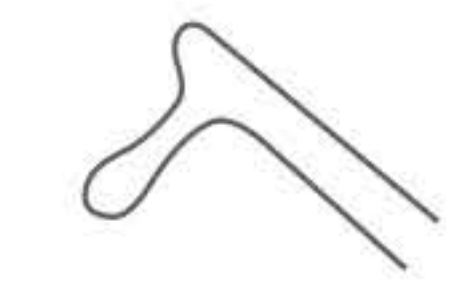

Catalog #	Size, Tip Diameter
OP-735-12	12 cm (4 3/4"), Ø 0.2 mm

Aker Lens Pusher

Smooth, Fish Mouth Shaped Tip, With Guard

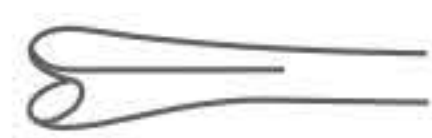

Catalog #	Size
OP-738-12	12.5 cm (5")

Bechert Lens Pusher

Vertical, Y Shaped Tip, Angled



Catalog #	Size
OP-739-11	11.5 cm (4 1/2")

Elsching Cyclodialysis Spatula

Flat



Catalog #	Size
OP-741-13	13 cm (5")

Castroviejo Synechiaie Spatula

Semi Sharp Tips



Catalog #	Size, Width
OP-743-13	13 cm (5"), 0.5 mm

Ophthalmology Instruments
 Ophthalmologie Instrumente
 Oftalmologia Instrumentos
 Ophthalmologie Instruments
 Oftalmologia Strumenti

Castroviejo Cyclodialysis Spatula



Catalog #	Size, Width
OP-745-25	13 cm (5"), 0.25 mm
OP-745-50	13 cm (5"), 0.5 mm

Lewis Lens Loop



Catalog #	Size, Profile
OP-750-01	13 cm (5"), Small
OP-750-02	14 cm (5 1/2"), Large

New Orleans Lens Loop



Catalog #	Size
OP-752-13	13 cm (5")

Wilder Lens Loop
Serrated



Catalog #	Size
OP-754-13	13.5 cm (5 1/4")

Kirby Lens Loop and Muscle Hook



Catalog #	Size
OP-757-15	15 cm (6")

Ophthalmology Instruments
 Ophthalmologie Instrumente
 Oftalmología Instrumentos
 Ophtalmologie Instruments
 Oftalmologia Strumenti

Morrison Lens Loop and Probe



Catalog #	Size
OP-758-14	14.5 cm (5 3/4")

Kansas Lens Loop
Serrated



Catalog #	Size, Width
OP-760-13	13.5 cm (5 1/4"), 3 mm

Keener-Arlt Lens Loop
Serrated



Catalog #	Size, Width
OP-761-13	13.5 cm (5 1/4"), 3 mm

Alfonso Nucleus Trisector
For Use With Ref: OP-775-02



Catalog #	Size, Width
OP-765-10	10.5 cm (4 1/4"), 1.5 mm

Bucher-Kansas Nucleus Trisector
For Use With Ref: OP-775-03



Catalog #	Size, Width
OP-767-10	10.5 cm (4 1/4"), 2.5 mm

Ophthalmology Instruments
 Ophthalmologie Instrumente
 Oftalmología Instrumentos
 Ophtalmologie Instruments
 Oftalmologia Strumenti

Kansas Nucleus Trisector
 For Use With Ref: OP-773-12



Catalog #	Size, Width
OP-769-11	11 cm (4 1/4"), 4 mm

Kansas Nucleus Bisector



Catalog #	Size
OP-771-11	11.5 cm (4 1/2")

Kansas Nucleus Vectis



Catalog #	Size
OP-773-12	12 cm (4 3/4")

Alfonso Cutting Platform



Catalog #	Size, Width
OP-775-02	12.5 cm (5"), 2 mm
OP-775-03	12.5 cm (5"), 3 mm

Giannetti Nucleus Capture Spoon



Catalog #	Size
OP-779-12	12.5 cm (5")

Ophthalmology Instruments
 Ophthalmologie Instrumente
 Oftalmología Instrumentos
 Ophtalmologie Instruments
 Oftalmologia Strumenti

Giannetti Nucleus Capture Spatula



Catalog #	Size
OP-781-12	12.5 cm (5")

Giannetti Nucleus Capture Hook



Catalog #	Size
OP-783-12	12.5 cm (5")

Culler Lens Spoon
 Sterling Silver



Catalog #	Size
OP-790-13	13 cm (5")

Paton Spatula & Spoon
 For Corneal Button Transfer



Catalog #	Size
OP-793-14	14 cm (5 1/2")

Rosenwasser Lamella Donor Shovel



Catalog #	Size, Width, Profile
OP-795-04	11.5 cm (4 1/2"), 4 mm, With Retaining Rim on 2 Sides
OP-795-05	11.5 cm (4 1/2"), 5 mm, With Retaining Rim on 3 Sides



Ophthalmology Instruments
 Ophthalmologie Instrumente
 Oftalmología Instrumentos
 Ophthalmologie Instruments
 Oftalmologia Strumenti

Bunge Evisceration Spoon



Catalog #	Size
OP-800-01	13.5 cm (5 1/4"), Small
OP-800-02	14 cm (5 1/2"), Large

Wells Enucleation Spoon



Catalog #	Size
OP-802-15	15 cm (6")

Graether Collar Button
 Straight



Catalog #	Size
OP-804-12	12.5 cm (5")

Ophthalmology Instruments
 Ophthalmologie Instrumente
 Oftalmología Instrumentos
 Ophtalmologie Instruments
 Oftalmologia Strumenti

Graether Collar Button
 Angled

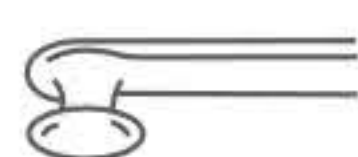

Catalog #	Size
OP-805-12	12.5 cm (5")

Z Hook Manipulator
 Z Shaped Blunt Tip



Catalog #	Size, Tip Diameter
OP-811-11	11.5 cm (4 1/2"), Ø 0.15 mm

Reversed Sinskey Hook
 Blunt Tip



Catalog #	Size, Tip Diameter
OP-813-11	11.5 cm (4 1/2"), Ø 0.2 mm

Bonn Micro Iris Hook
 Blunt Tip



Catalog #	Size
OP-815-12	12.5 cm (5")

Shephard Iris Hook
 Blunt Tip



Catalog #	Size
OP-817-12	12.5 cm (5")

Jaff Lens Manipulating Hook
 Blunt Tip, Straight



Catalog #	Size, Tip Diameter
OP-819-01	11.5 cm (4 1/2"), Ø 0.15 mm

Clayman-Jaffe Lens Manipulating Hook
 Blunt Tip, Angled



Catalog #	Size, Tip Diameter
OP-819-02	11.5 cm (4 1/2"), Ø 0.15 mm

Sinsky Lens Manipulating Hook
 Blunt Tip, Straight



Catalog #	Size, Tip Diameter
OP-821-01	11.5 cm (4 1/2"), Ø 0.25 mm

Harris-Sinsky Lens Manipulating Hook
 Blunt Tip, Angled



Catalog #	Size, Tip Diameter
OP-821-02	11.5 cm (4 1/2"), Ø 0.25 mm

Lewicky Lens Manipulating Hook
 Blunt Tip, Angled



Catalog #	Size, Tip Diameter
OP-823-12	12 cm (4 3/4"), Ø 0.5 mm

Ophthalmology Instruments
 Ophthalmologie Instrumente
 Oftalmología Instrumentos
 Ophtalmologie Instruments
 Oftalmologia Strumenti

Hirschman Iris Hook
 Blunt, Angled



Catalog #	Size
OP-825-11	11 cm (4 1/4")

Sinskey Lens Manipulating Hook



Catalog #	Size, Tip Diameter, Profile
OP-826-01	11.5 cm (4 1/2"), Ø 0.25 mm, Straight
OP-826-02	11.5 cm (4 1/2"), Ø 0.25 mm, Angled

Sinskey II Lens Manipulating Hook
 Straight

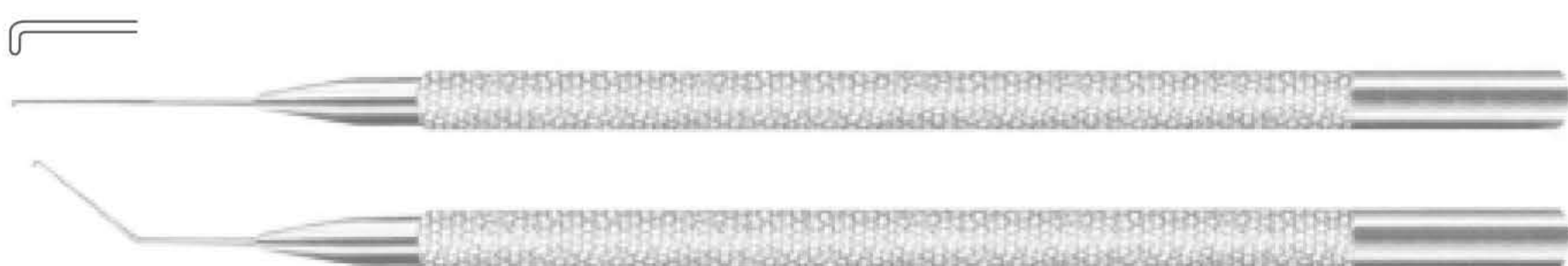

Catalog #	Size, Tip Diameter, Profile
OP-826-03	11.5 cm (4 1/2"), Ø 0.2 mm, Straight
OP-826-04	11.5 cm (4 1/2"), Ø 0.2 mm, Angled

Kuglen Iris Hook and Lens Manipulator
 Push Pull Model



Catalog #	Size, Profile
OP-827-01	11.5 cm (4 1/2"), Straight
OP-827-02	11.5 cm (4 1/2"), Angled

Kuglen Iris Hook and Lens Manipulator
 Clover Leaf Model



Catalog #	Size
OP-829-01	11.5 cm (4 1/2")

Ophthalmology Instruments
 Ophthalmologie Instrumente
 Oftalmología Instrumentos
 Ophtalmologie Instruments
 Oftalmologia Strumenti

Rentsch Boat Hook
 Straight With Guard

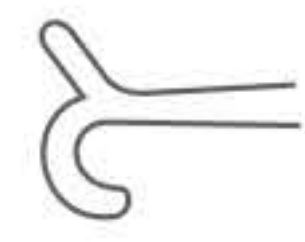

Catalog #	Size
OP-831-12	12 cm (4 ¾")

Osher Y Hook
 Straight With Guard

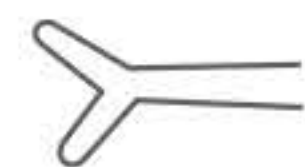

Catalog #	Size
OP-833-12	12 cm (4 ¾")

Fenzl Lens Manipulating Hook
 Straight With Guard

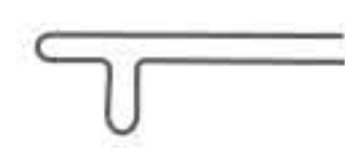

Catalog #	Size, Tip Diameter
OP-835-01	12 cm (4 ¾"), Ø 0.15 mm

Fenzl Lens Manipulating Hook
 Angled

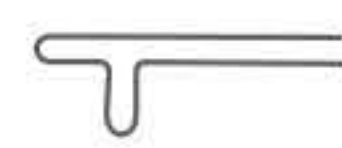

Catalog #	Size, Tip Diameter
OP-835-02	12 cm (4 ¾"), Ø 0.15 mm

Maltzman-Fenzl Lens Manipulating Hook
 Straight With Guard



Catalog #	Size, Tip Diameter
OP-837-01	12 cm (4 ¾"), Ø 0.15 mm

Ophthalmology Instruments
 Ophthalmologie Instrumente
 Oftalmología Instrumentos
 Ophtalmologie Instruments
 Oftalmologia Strumenti

Maltzman-Fenzl Lens Manipulating Hook
 Angled



Catalog #	Size, Tip Diameter
OP-837-02	12 cm (4 3/4"), Ø 0.15 mm

Jaffe-Maltzman Lens Manipulating Hook
 Angled



Catalog #	Size, Tip Diameter
OP-839-02	12 cm (4 3/4"), Ø 0.15 mm

Giannetti Push Pull Manipulator



Catalog #	Size
OP-841-01	12.5 cm (5")

Deitz ICL Manipulator
 Blunt Forked Tip



Catalog #	Size
OP-843-02	12 cm (4 3/4")

Fixation Hook
 Sharp

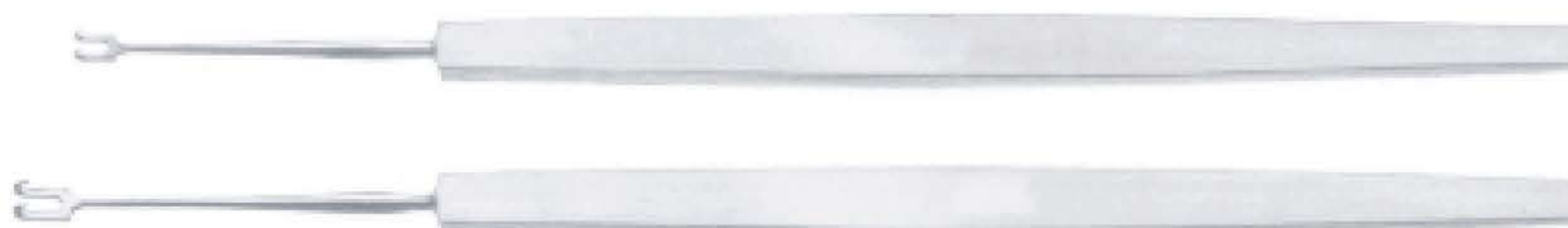

Catalog #	Size, Profile
OP-845-01	12.5 cm (5"), Small
OP-845-02	13 cm (5"), Large

Twist Hook



Catalog #	Size, Profile
OP-849-01	11 cm (4 1/4"), Right
OP-849-02	11 cm (4 1/4"), Left

Silverman Fixation Hook



Catalog #	Size
OP-851-09	9.5 cm (3 3/4")

Lu-Mendez LRI Guide and Fixation Ring

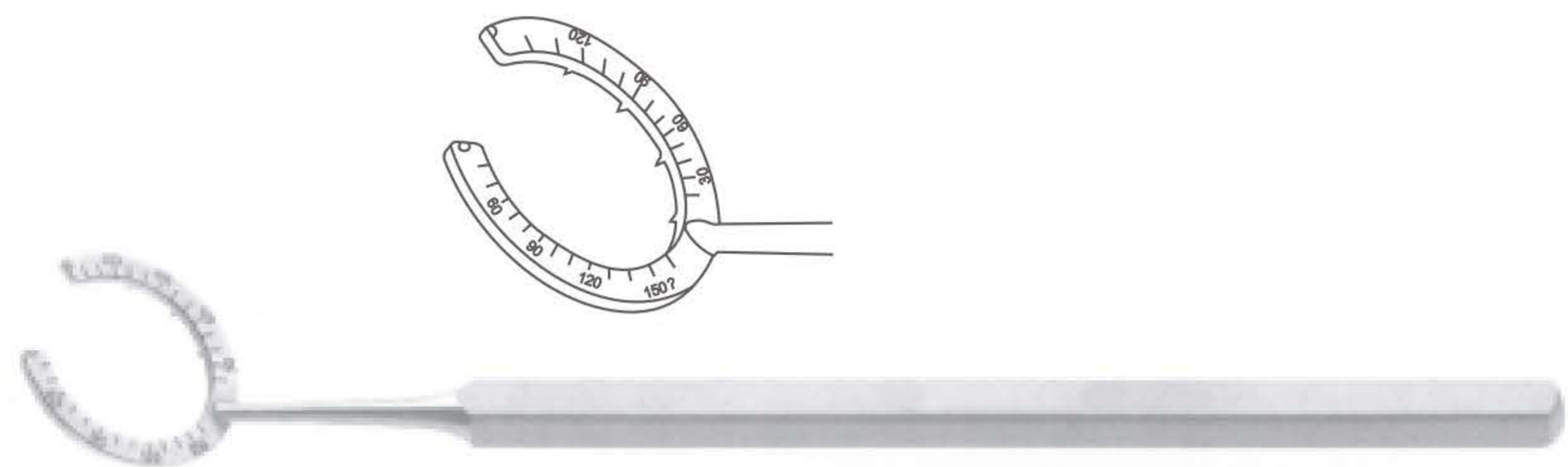

Catalog #	Size, I.D
OP-861-11	11 cm (4 1/4"), 11 mm

**Gimbel Stabilization Ring
 With Swivel Handle**



Catalog #	Size, Tip Diameter
OP-863-11	11.5 cm (4 1/2"), 13 mm

**Fine-Thronton Swivel Fixation Ring
 With Swivel Handle**

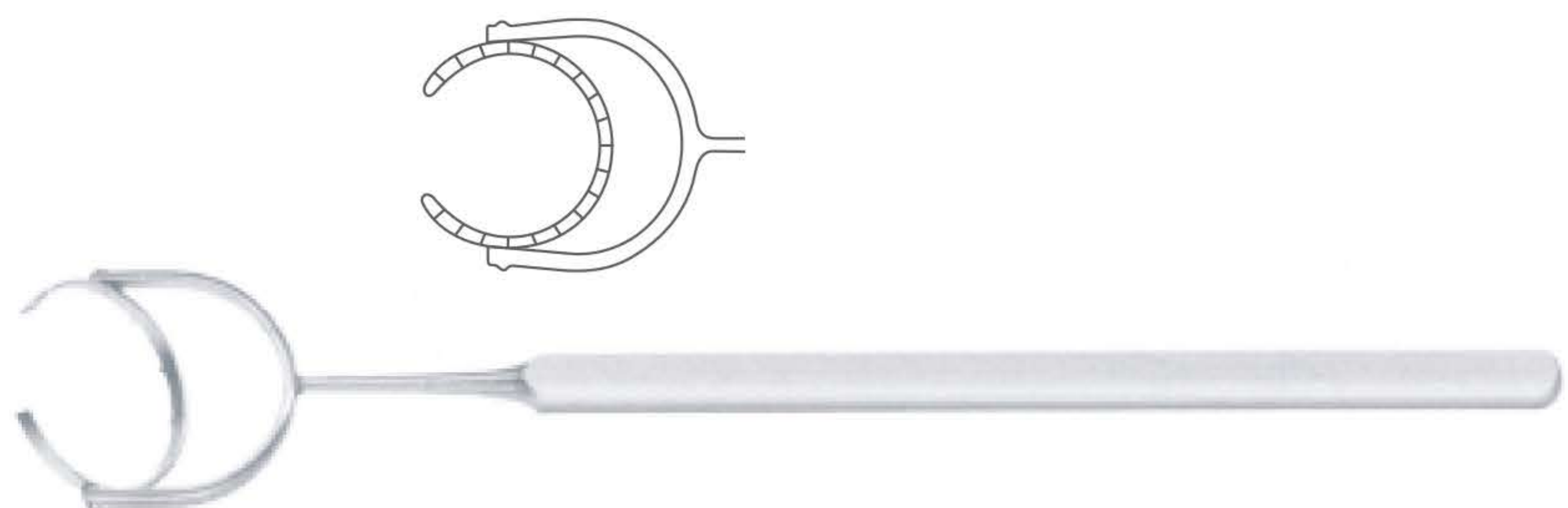

Catalog #	Size, Tip Diameter
OP-865-13	12 cm (4 3/4"), 13 mm
OP-865-16	12 cm (4 3/4"), 16 mm

Ophthalmology Instruments
 Ophthalmologie Instrumente
 Oftalmologia Instrumentos
 Ophtalmologie Instruments
 Oftalmologia Strumenti

Thronton Globe Fixation Ring



Catalog #	Size, Tip Diameter
OP-867-10	10 cm (4"), 16 mm

Hofmann-Thronton Globe Fixation Ring
 With Swivel Handle



Catalog #	Size, Tip Diameter
OP-869-11	11 cm (4 1/4"), 16 mm

Stevens Tenotomy Hook
 Blunt, Small



Catalog #	Size
OP-871-12	12.5 cm (5")

Helveston Teaser Hook
 Extra Delicate, Blunt



Catalog #	Size
OP-873-12	12.5 cm (5")

Gass Retinal Detachment Hook
 With Oval Hole



Catalog #	Size
OP-875-13	13 cm (5")

Ophthalmology Instruments
 Ophthalmologie Instrumente
 Oftalmología Instrumentos
 Ophthalmologie Instruments
 Oftalmologia Strumenti

Helveston Finder Hook

Catalog #	Size, Profile
OP-877-01	12.5 cm (5")?, Large
OP-877-02	12 cm (4 3/4"), Small

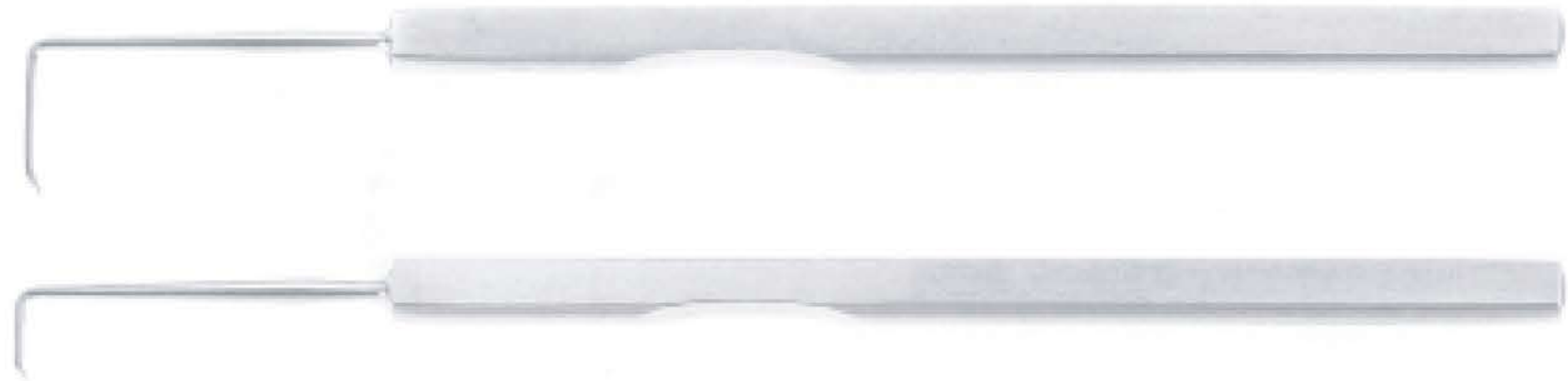

Helveston Muscle Hook

Catalog #	Size, Tip Length, Profile
OP-879-01	13 cm (5"), 8 mm, Fig. 1
OP-879-02	13 cm (5"), 10 mm, Fig. 2
OP-879-03	13 cm (5"), 12 mm, Fig. 3

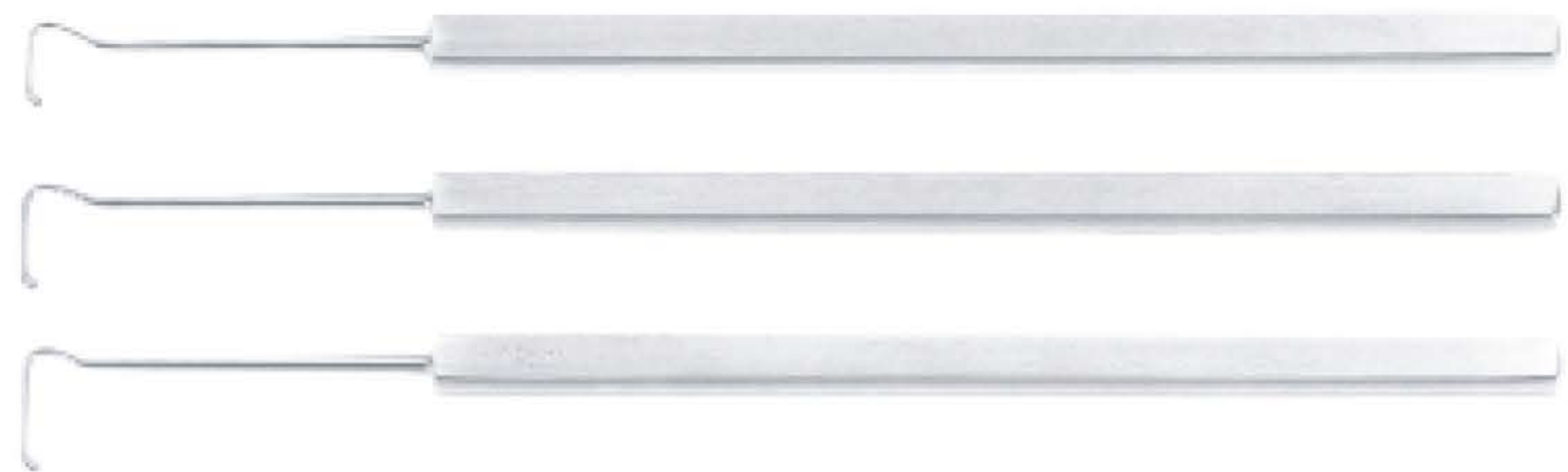

Jameson Muscle Hook

Catalog #	Size, Profile
OP-881-01	13 cm (5"), Small
OP-881-02	13.5 cm (5 1/4"), Large

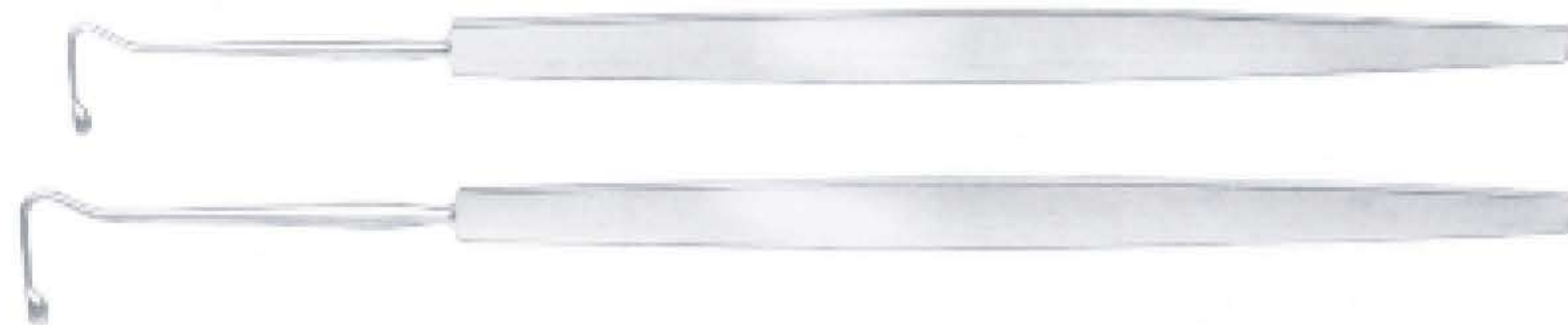

Green Muscle Hook

Catalog #	Size
OP-883-13	13.5 cm (5 1/4")



Ophthalmology Instruments
 Ophthalmologie Instrumente
 Oftalmología Instrumentos
 Ophthalmologie Instruments
 Oftalmologia Strumenti

Kellen Capsulorrhexis Marker
 6 mm Diameter Marking Ring With 2.5 mm Extensions



Catalog #	Size
OP-891-11	11.5 cm (4 1/2")

Maloney Intra-Operative Keratometer
 For Qualitative Measurement of Astigmatism



Catalog #	Size
OP-900-00	11.5 cm (4 1/2")

Mendez Degree Guage



Catalog #	Size
OP-901-11	11.5 cm (4 1/2")

Greene Visual Axis Marker
 Concave Tip



Catalog #	Size, Tip Diameter
OP-905-11	11.5 cm (4 1/2"), 0.5 mm

Ophthalmology Instruments
 Ophthalmologie Instrumente
 Oftalmología Instrumentos
 Ophthalmologie Instruments
 Oftalmologia Strumenti

McDonald Optic Zone Marker
 Double End With Cross Hairs



Catalog #	Size, Tip Diameter 1, Tip Diameter 2
OP-907-11	11 cm (4 1/4"), 6.5 mm, 7.0 mm

Bores Optic Zone Marker

Catalog #	Size, Tip Diameter
OP-911-01	10.5 cm (4 1/4"), 3.0 mm
OP-911-02	10.5 cm (4 1/4"), 3.25 mm
OP-911-03	10.5 cm (4 1/4"), 3.5 mm
OP-911-04	10.5 cm (4 1/4"), 3.75 mm
OP-911-05	10.5 cm (4 1/4"), 4.0 mm
OP-911-06	10.5 cm (4 1/4"), 4.25 mm
OP-911-07	10.5 cm (4 1/4"), 4.5 mm
OP-911-08	10.5 cm (4 1/4"), 4.75 mm
OP-911-09	10.5 cm (4 1/4"), 5.0 mm
OP-911-10	10.5 cm (4 1/4"), 6.0 mm
OP-911-11	10.5 cm (4 1/4"), 7.0 mm
OP-911-12	10.5 cm (4 1/4"), 8.0 mm
OP-911-13	10.5 cm (4 1/4"), 9.0 mm



Ophthalmology Instruments
 Ophthalmologie Instrumente
 Oftalmología Instrumentos
 Ophtalmologie Instruments
 Oftalmologia Strumenti

Hoffer Optic Zone Marker
 With Cross Hairs



Catalog #	Size, Tip Diameter
OP-913-01	10.5 cm (4 1/4"), 3.0 mm
OP-913-02	10.5 cm (4 1/4"), 3.25 mm
OP-913-03	10.5 cm (4 1/4"), 3.5 mm
OP-913-04	10.5 cm (4 1/4"), 3.75 mm
OP-913-05	10.5 cm (4 1/4"), 4.0 mm
OP-913-06	10.5 cm (4 1/4"), 4.25 mm
OP-913-07	10.5 cm (4 1/4"), 4.5 mm
OP-913-08	10.5 cm (4 1/4"), 4.75 mm
OP-913-09	10.5 cm (4 1/4"), 5.0 mm
OP-913-10	10.5 cm (4 1/4"), 5.5 mm
OP-913-11	10.5 cm (4 1/4"), 6.0 mm
OP-913-12	10.5 cm (4 1/4"), 7.0 mm
OP-913-13	10.5 cm (4 1/4"), 8.0 mm
OP-913-14	10.5 cm (4 1/4"), 9.0 mm

Anis Radial Marker



Catalog #	Size, Center Opening, O.D, Profile
OP-915-08	10 cm (4"), 4.0 mm, Ø 12.5 mm, 8 Blades
OP-915-12	10 cm (4"), 4.0 mm, Ø 12.5 mm, 12 Blades
OP-915-16	10 cm (4"), 4.0 mm, Ø 12.5 mm, 16 Blades

Anis Suture Placement Marker
 8 Radial Blades



Catalog #	Size, Center Opening
OP-917-10	10 cm (4"), 8 mm

Ophthalmology Instruments
 Ophthalmologie Instrumente
 Oftalmología Instrumentos
 Ophthalmologie Instruments
 Oftalmologia Strumenti

Fechtner Trabeclectomy Marker

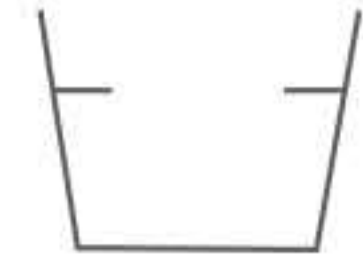

Catalog #	Size
OP-919-09	9 cm (3 1/2")

Helveston Scleral Ruler
 15 mm Long in Notches in 5 mm Increments



Catalog #	Size
OP-930-12	12 cm (4 3/4")

Stahl Corneal Caliper

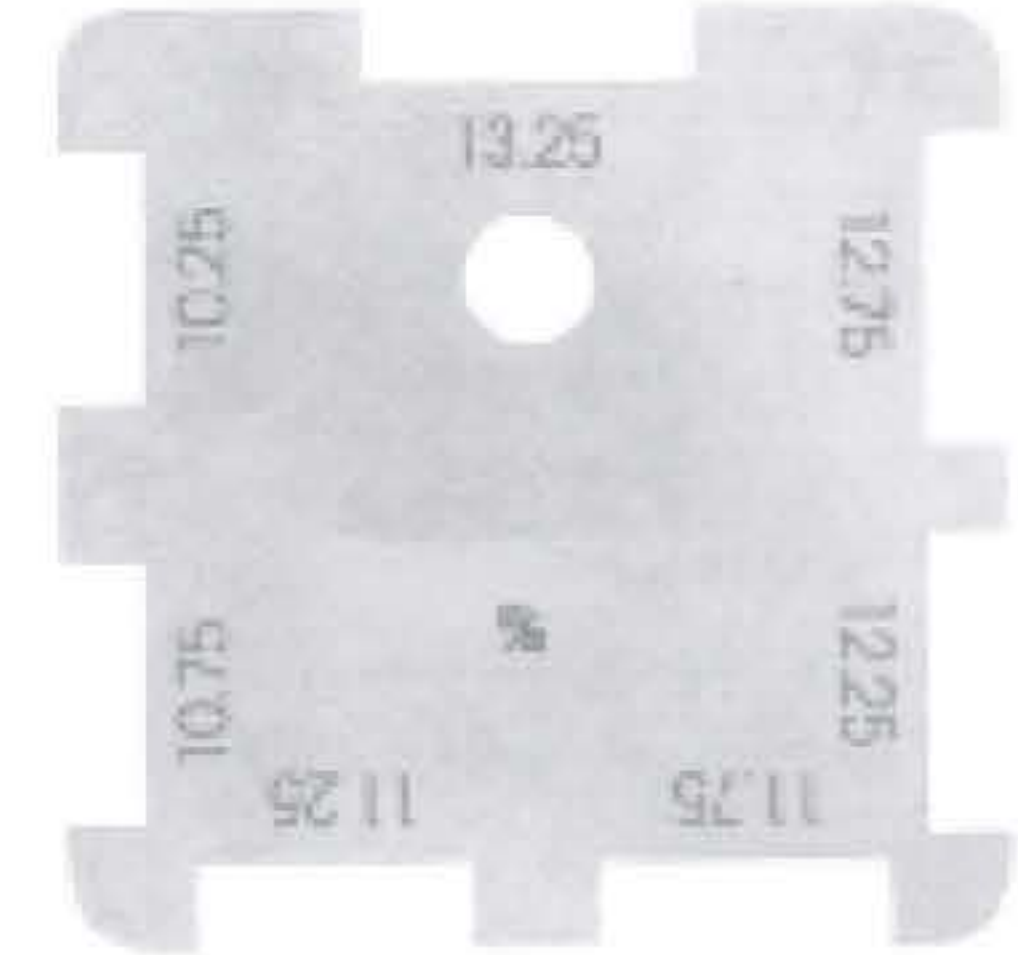
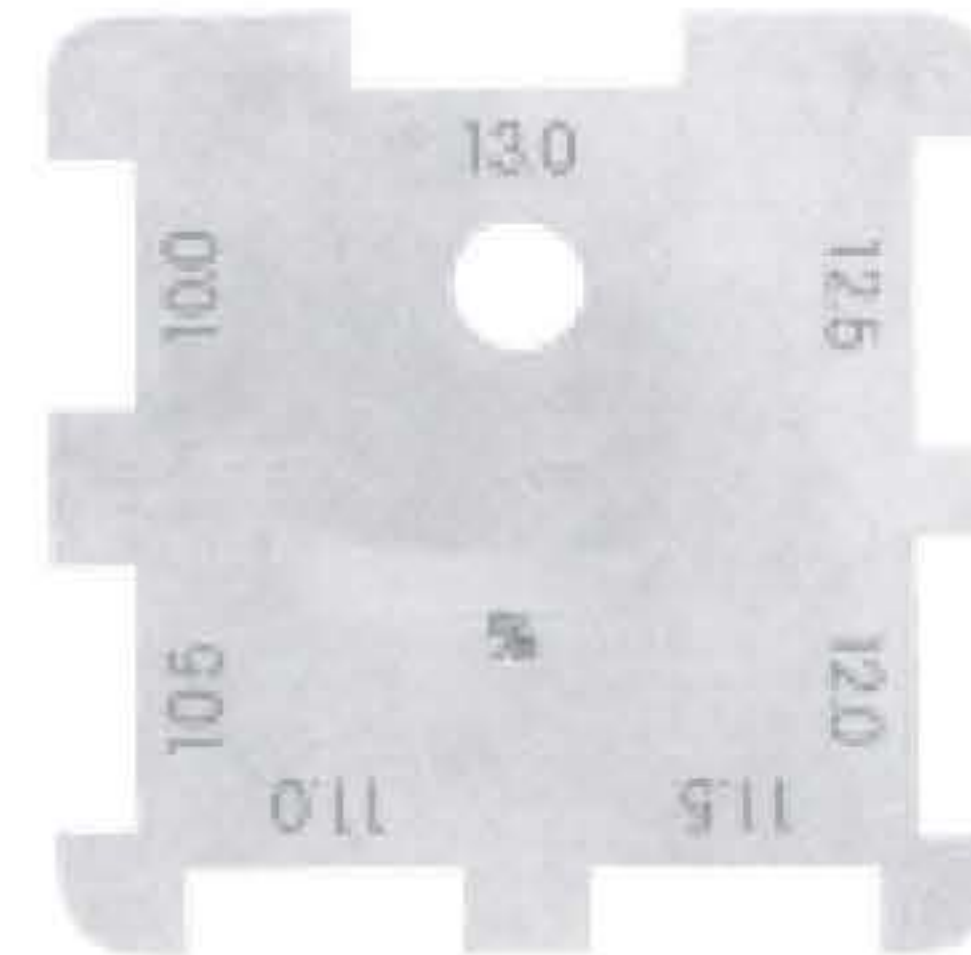

Catalog #	Size
OP-932-01	N/A
OP-932-02	N/A

OP-932-01

OP-932-02

Harms Trabeculotomy Probe



Catalog #	Size, Profile
OP-941-01	5 cm (2"), Right
OP-941-02	5 cm (2"), Left

Infant Lacrimal Dilator
 Very Fine Blunt Tip



Catalog #	Size
OP-944-08	8 cm (3")

Ophthalmology Instruments
 Ophthalmologie Instrumente
 Oftalmología Instrumentos
 Ophtalmologie Instruments
 Oftalmologia Strumenti

Muldoon Lacrimal Dilator



Catalog #	Size
OP-946-10	10 cm (4")

Wilder Lacrimal Dilator



Catalog #	Size, Profile
OP-948-01	10.5 cm (4 1/4"), Fine Taper, Size 1
OP-948-02	10.5 cm (4 1/4"), Medium Taper, Size 2
OP-948-03	10.5 cm (4 1/4"), Heavy Taper, Size 3

Castroviejo Lacrimal Dilator
 Double Ended Fine and Medium Taper



Catalog #	Size
OP-950-14	14 cm (5 1/2")